

Value Chain of High Value Highly Perishable Vegetables

C.P. Hathurusinghe

Research Report No: 181

April 2015

**Hector Kobbekaduwa Agrarian Research and Training Institute
114, Wijerama Mawatha
Colombo 7
Sri Lanka**

First Published: April 2015

© 2015, Hector Kobbekaduwa Agrarian Research and Training Institute

Final typesetting and lay-out by: Dilanthi Hewavitharana

Coverpage Designed by: Udeni Karunaratne

ISBN: 978-955-612-186-5

FOREWORD

In the agricultural sector, fresh vegetables have the most potential to respond to market opportunities rapidly because of their shorter growing period. The cultivation of high value highly perishable fresh vegetables such as lettuce, parsley, celery, iceberg, bell pepper, cauliflower and broccoli has increased and the new generation has entered this sector to increase their farm income. They cultivate these crops in open fields and in protected areas to fulfill the demand in the local as well as in the export market. The demand from local urban consumers has increased very slowly with the awareness of the nutritional values of these crops instead of high prices. Vegetables have important components of a healthy diet and sufficient daily consumption of cauliflower and lettuce could help prevent major diseases such as cardiovascular diseases and certain cancers. Small farmers had the experience of obtaining a higher income and various types of new varieties of high value new vegetables have been cultivated mainly in the Nuwara Eliya and Bandarawela areas. Cultivation of some of these crops has spread in Dambulla and Kalpitiya areas too.

To enhance the knowledge, this study reviewed the overall situation of high value highly perishable crops in the vegetable sub sector of Sri Lankan agribusiness, and identified the constraints and proposes the remedial measures. I wish this study will provide input as a basis to design a development strategy for the rational economic growth. During the last decade these vegetables are supplied to the open market in small quantities compared to that of other exotic vegetables and comparatively a higher quantity is supplied especially to the new supermarket chains, green vegetable outlets, restaurants and the export market. The information showed that there is a potential to create employment for the rural poor by increasing the production, processing and marketing of high value crops through new policy reforms.

I would like to thank Mrs. C.P. Hathurusinghe, Research Fellow, who coordinated and prepared this report and the HARTI staff for their cooperation.

Mr. E.M. Abhayaratne
Director/HARTI

ACKNOWLEDGEMENTS

First of all, I wish to express my appreciation to Mr. K.E. Karunathilake, Former Secretary/ Ministry of Agriculture for encouraging me to study this sector. My gratitude is expressed to the officials of the Agriculture Department, Agrarian Services Department, Sri Lanka Customs, Census and Statistics Department for their cooperation in providing data and information required for this study. I also wish to express my gratitude to the farmers and traders who devoted their valuable time for me in providing information and data required for this study.

A special note of appreciation is due to Mr. Ajith Rathnasiri (Statistical Officer) and Messers. J.C.K.B. Lionel, H.M.S. Jayaratne and B.W.G.S.K. Nillamulla (Statistical Assistants) and L.D. Wickramasinghe and Miss S.A.J. Dissanayake (Investigators) of the Marketing Food Policy and Agribusiness Division for helping me to collect field level data and information and to prepare tables related to this study.

My gratitude is expressed to the members of Research and Training Committee for their valuable comments. A special note of appreciation goes to Prof. S.M.P. Senanayake, Professor of Economics/University of Colombo and Prof. Abeywickrama, Professor of Agricultural Economics, Faculty of Agriculture, University of Ruhuna for providing the professional input for subject matter editing. I also wish to thank Mr. J.K.M.D. Chandrasiri, Additional Director/Research and Dr. T.A. Dharmarathne, Head/MFPAD for their comments and support. I would also like to extend my gratitude to Ms. Suharshi Perera for final editing of the report.

I acknowledge the support and encouragement given by Mr. Lalith Kantha Jayasekara, Former Director of the Hector Kobbekaduwa Agrarian Research and Training Institute in the process of preparing the report. I wish to express my appreciation to Mr. E.M. Abhayaratne, Director of the Hector Kobbekaduwa Agrarian Research and Training Institute, for his cooperation in publishing this report.

I also wish to thank Mrs. Dilanthi Hewavitharana, Secretary for page settings and Mrs. Udeni Karunaratne for cover page designing and the printing staff of HARTI for their hard work.

I wish to express my gratitude to HARTI staff for their various forms of support to fulfill this task.

C.P. Hathurusinghe

ABSTRACT

Fresh vegetables have the most potential to respond to market opportunities rapidly because of their shorter growing period. Any marketable vegetable crop suitable to increase income or to reduce income instability of the poor farmers is called “high value” in the context of crops. This study limits its selection of commodities to potentially profitable and of substantial nutritional value, which have a demand in domestic as well as in export market. In this context cauliflower, broccoli, Chinese cabbage, bell pepper and lettuce were selected. The purpose of the study was to review the overall situation of high value highly perishable crops in the vegetable sub sector of Sri Lankan agribusiness and to identify, assess, and prioritize constraints and to find out the remedial measures and crosscutting policy reforms to enhance competitiveness, growth, employment, and business opportunities in the country. The channel mapping methodology was used to analyze the value chain. Based on the identified supply channels, an end market study was done to understand market requirements and critical success factors.

The study revealed that the cultivation of high value highly perishable vegetables such as lettuce, parsley, celery, iceberg, Pak Choy, bell pepper, cauliflower, broccoli and cucumber has increased by 35–40 percent during the years 2010 and 2011 due to increased demand from hotels which cater to foreigners. About 50 farmers entered this crop sector in 2009 and this number had increased by 85 percent in 2010. From 2010 to 2011 about 32 percent increase could be observed. The cost of production of most of these high value highly perishable crops is less than 15 percent out of the retail price. The supply chains were very clear and short because farmers and traders are linked well in the value chain to minimize losses by satisfying the consumers. New generation has entered this sector due to increased demand in the local as well as in the export market and also because of high prices, higher profit margins and higher income compared to those of other vegetables. The profit margin of cauliflower, broccoli and bell pepper ranged between 31 to 36 percent out of the retail price, while that of Chinese cabbage, iceberg, red lettuce and Pak Choy ranged between 13 to 17 percent. To get a good appearance and good income farmers use agro chemicals as well as chemical fertilizer. It was identified that farmers do mixed cropping in order to maximize their farm income. Rising income had stimulated producers and agribusiness entrepreneurs to supply new varieties of high value vegetables to meet the increasing demand in local markets for fresh vegetables and in hotels and food stalls for processed food. As a result, some of the farmers reinvest their income for these new vegetables to earn higher profits by reducing the cultivation of less profitable traditional types of vegetables and potatoes. The development of this vegetable subsector has shown significant impacts in poverty reduction of smallholder farmers mainly in the Uva Paranagama area in Bandarawela and Meepilimana area in Nuwara Eliya. There is a potential to enhance the incomes of small farmers and create employment for rural

labourers by increasing production, processing and marketing of high value crops. Though these crops are available in the market, the demand from local consumers increases very slowly due to high prices and lack of awareness on culinary preparations. As almost all the farmers and many consumers are not aware of the nutritional values of these crops they do not consume these vegetables. In the urban areas both the supply and demand have increased because the affordable consumers pay for these vegetables and due to changing food habits and awareness on nutritional value of each crop.

The study findings provide input as the basis to design a development strategy for the rational economic growth. To enhance the domestic demand for these products the awareness programmes should be conducted by focusing the younger generation. Another important intervention is to make youth farmers aware of minimizing agrochemical usage for these crops because most of these products are consumed fresh.

LIST OF CONTENTS

	Page No.
FOREWORD	i
ACKNOWLEDGEMENTS	ii
ABSTRACT	iii
LIST OF CONTENTS	v
LIST OF TABLES	vii
LIST OF FIGURES	ix
ANNEXURES	xi
CHAPTER ONE	
Introduction	1
1.1 Introduction	1
1.2 Background	2
1.3 Problem	7
1.4 Objectives of the Study	8
1.5 Methodology	9
1.6 Structure of the Report	10
CHAPTER TWO	
Overview of the High Value Vegetable Sub Sector	11
2.1 Introduction	11
2.2 Development of the Crop Sector	11
2.3 Cultivation Practices	13
2.3.1 Lettuce and Pak Choy Cultivation	13
2.3.2 Cauliflower and Broccoli Cultivation	20
2.3.3 Cucumber Cultivation	23
2.3.4 Bell Pepper Cultivation	24
2.4 Behaviour of Farmers	29
2.5 Overview of the Marketing of High Value Vegetables	31
2.6 Price Behaviour of High Value Vegetables	36
CHAPTER THREE	
Value Chain Analysis of High Value Vegetable Sub Sector	51
3.1 Introduction	51

3.2	Institutional Support	52
3.3	Value Chain Analysis of High Value Highly Perishable Vegetables	52
CHAPTER FOUR		
Constraints Faced by Growers, Traders, Exporters and Consumers		79
CHAPTER FIVE		
Summary, Conclusion and Suggestions		81
5.1	Summary and Conclusion	81
5.2	Suggestions	89
	Reference	90

LIST OF TABLES

		Page No.
Table 2.1	Top Ten Lettuce and Chicory Producing Countries - 2010	17
Table 2.2	Nutritional Value per 100g of Butterhead Lettuce	18
Table 2.3	Nutrient Composition of Iceberg Lettuce	19
Table 2.4	Nutritional Value of Cauliflower per 100g	21
Table 2.5	Weekly Producer Prices and Wholesale Prices of Cauliflower in Dambulla	22
Table 2.6	Cost of Construction of a Poly Tunnel and Planting Pots (Rs)	24
Table 2.7	Average Production of Bell Pepper from 1000sq Poly Tunnel	25
Table 2.8	Nutritional Value per 100g of Bell Pepper Sweet, Green, Raw	27
Table 2.9	Bell Pepper Purchases at the UPEPV and Value of the Purchases	28
Table 2.10	Cultivation under Poly Tunnels by Farmers in Uva Paranagama Area	30
Table 2.11	Number of Farmers Linked to UPEPV and Their Sales	32
Table 2.12	Cropping Pattern of High Value Vegetables and the Number of Farmers in the Supply Chain	33
Table 2.13	Number of Farmers in the Supply Chain through UPEPV	34
Table 2.14	Sales Quantities and Earnings of Farmers in 2011	34
Table 2.15	No. of Bell Pepper Farmers and Their Sales through UPEPV – 2011	35
Table 2.16	UPEPV High Value Crop Purchases	40
Table 2.17	Purchased Quantities of High Value Vegetables by the UPEPV - 2010 & 2011	41
Table 2.18	Purchased Quantities of High Value Vegetables by the UPEPV-2010 & 2011	41
Table 2.19	Monthly Average Producer Prices of Bell Pepper in Bandarawela - 2010 & 2011	42
Table 2.20	Monthly Average Producer Prices of Bell Pepper in Bandarawela - 2010 & 2011 (Rs/kg)	45
Table 2.21	Monthly Average Producer Prices of Celery, Chinese Cabbage, Iceberg and Cucumber in Bandarawela - 2010 & 2011 (Rs/kg)	45
Table 2.22	Monthly Average Producer Prices of Greenhouse Tomato, Pak Choy, Red Cabbage and Lettuce in Bandarawela - 2010 & 2011 (Rs/kg)	46
Table 2.23	Monthly Wholesale Price Ranges of Cucumber and Bell Pepper in Bandarawela – 2012	46

Table 2.24	Average Daily Demand of High Value Vegetables from Leading Collectors per Month in 2011 (kg)	47
Table 2.25	Average Daily Demand of High Value Vegetables for each Month in 2012 (kg)	47
Table 2.26	Monthly Average Wholesale Prices of High Value Vegetables in Nuwara Eliya in 2011 (Rs/kg)	49
Table 2.27	Monthly Average Wholesale Prices of High Value Vegetables in Nuwara Eliya in 2012 (Rs/kg)	49
Table 3.1	Price Spread between Producer and Consumer as a % of Consumer Rupee	57
Table 3.2	Gross Margin of Cauliflower at Dambulla Market -2012	62
Table 3.3	Value Chain of Cauliflower and Broccoli	63
Table 3.4	Value Chain of Cauliflower – Supplied from Dambulla to Narahenpita DEC	63
Table 3.5	Value Chain of Chinese Cabbage and Iceberg	64
Table 3.6	Value Chain of Bell Pepper	65
Table 3.7	Value Chain of Tomato & Green Cucumber	66
Table 3.8	Value Chain of Lettuce & Pak Choy	67
Table 3.9	Price Spread of High Value Highly Perishable Vegetables (%)	68
Table 3.10	Price Spread of High Value Highly Perishable Vegetables (%) - continued	68
Table 3.11	Price Spread of High Value Highly Perishable Vegetables (%) - continued	68
Table 3.12	Cost of Production and Gross Margins at Various Levels as a Percentage of Retail Price	69
Table 3.13	Cost of Production of Cauliflower	73
Table 3.14	Value Chain of High Value Highly Perishable Vegetables	74
Table 3.15	Producer Price Ranges of High Value Vegetables in Uva Paranagama – (Rs/kg) 2012	76
Table 3.16	Producer Price Ranges and Gross Margins of High Value Vegetables between Uva Paranagama and Nuwara Eliya – (Rs/kg) July and August - 2012	76
Table 3.17	Average Cost of Production and Producer’s Margin at Farm Level as a Percentage of Retail Price	77

LIST OF FIGURES

		Page No.
Figure 2.1	Average Producer Prices and Wholesale Prices of Cauliflower in Dambulla	23
Figure 2.2	Bell Pepper Production under 1000sq Poly Tunnel	26
Figure 2.3	Weekly Average Tomato Production under 1000sq feet Poly Tunnel	28
Figure 2.4	Number of Farmers Engaged in High Value Crop Production in Uva Paranagama Area -2010	30
Figure 2.5	Average Daily Demand from Main Collectors in Nuwara Eliya	35
Figure 2.6	Average Daily Demand from Main Collectors in Nuwara Eliya –Lettuce & Tomato	36
Figure 2.7	Producer Price Ranges of Bell Pepper – green 2011-12	37
Figure 2.8	Producer Price Ranges of Bell Pepper – red 2011-12	38
Figure 2.9	Producer Price Ranges of Bell Pepper – yellow 2011-12	38
Figure 2.10	Producer Price Ranges of Tomato 2011-12	39
Figure 2.11	Producer Price Ranges of Cucumber - Green 2011-12	39
Figure 2.12	Monthly Purchases of Bell Pepper – UPEPV -2012	43
Figure 2.13	Monthly Purchases of Tomato – UPEPV -2012	43
Figure 2.14	Monthly Purchases of Cucumber - Green – UPEPV -2012	44
Figure 2.15	Monthly Purchases of Bell pepper – Grade 2 – UPEPV -2012	44
Figure 3.1	Input Supplies and Distribution System	54
Figure 3.2	Main Activities throughout the Supply Chain	55
Figure 3.3	Value Chain Map of High Value Vegetables	56
Figure 3.4	Value Chain of Bell pepper - Green (Rs/kg)	57
Figure 3.5	Value Chain of Bell pepper – Red & Yellow (Rs/kg)	57
Figure 3.6	Value Chain of Tomato (Poly tunnels) (Rs/kg)	58
Figure 3.7	Value Chain of Green Cucumber (Rs/kg)	58
Figure 3.8	Value Chain of Iceberg (Rs/kg)	58
Figure 3.9	Value Chain of Lettuce – Green (Rs/kg)	59
Figure 3.10	Value Cain of Lettuce - Red (Rs/kg)	59
Figure 3.11	Value Chain of Chinese Cabbage (Rs/kg)	59
Figure 3.12	Value Chain of Cauliflower (Rs/kg)	60
Figure 3.13	Value Chain of Cauliflower – Dambulla (Rs/kg)	60
Figure 3.14	Value Chain of Broccoli (Rs/kg)	60

Figure 3.15	Value Addition of Bell Pepper - Green	70
Figure 3.16	Value Addition of Bell Pepper Red & Yellow (Rs/kg)	70
Figure 3.17	Value Addition of Cauliflower – Nuwara Eliya (Rs/kg)	71
Figure 3.18	Value Addition of Broccoli (Rs/kg)	71
Figure 3.19	Value Addition of Lettuce – Green (Rs/kg)	71
Figure 3.20	Value Addition of Lettuce - Red	72
Figure 3.21	Value Addition of Green Cucumber (Rs/kg)	72
Figure 3.22	Value Addition of Chinese Cabbage (Rs/kg)	72
Figure 3.23	Value Addition of Pak Choy (Rs/kg)	73
Figure 3.24	Value Addition of Cauliflower – Dambulla (Rs/kg)	73
Figure 3.25	Value Chain of High Value Highly Perishable Vegetables	75
Figure 3.26	Retail Prices of lettuce at Pettah Market	77

ANNEXURES

		Page No.
Annex 1	Daily Supply Ranges to Leading Collectors (Kg/day)	93
Table 2.	Daily Requirement and Supply of High Value Vegetables 2011 & 2012 (kg)	97
Table 3	Sales of UPEPV to Leading Traders	101
Table 4	Purchased Quantities of High Value Vegetables by UPEPV 2010 – 2012 (kg)	101
Table 5	Margin Between Producer Price and Wholesale Price in the Producing Areas	102
Figures- Annex 2	Price Behaviour of High Value Highly Perishable Vegetables	104
Annex 3	Monthly Average Producer Prices & Purchases of Leading Collectors in Nuwara Eliya Jan 2011 –Nov 2012	109
Annex 4	Monthly Average Producer Prices & Purchased Quantities of Uva Paranagama Export Production Village Ltd	114
Annex 5	Monthly Average Producer Prices of High Value Highly Perishable Vegetables in Uva Paranagama Area 2010 - 2011-2012	116
Annex 6	Monthly Average Producer Prices of High Value Highly Perishable Vegetables in Nuwara Eliya 2011-2012	120
Annex 7	Producer Price Ranges of High Value Highly Perishable Vegetables in Nuwara Eliya -2012	125
Annex 8	Daily Purchases of High Value Highly Perishable Vegetables of UPEPV	130
Annex 9	Price Spread of High Value Highly Perishable Vegetables	134

CHAPTER ONE

Introduction

1.1 Introduction

In the agricultural sector, fresh vegetables have the most potential to respond to market opportunities rapidly because of their shorter growth period. The cultivation of high value highly perishable fresh vegetables such as lettuce, parsley, celery, iceberg, bell pepper, cauliflower and broccoli had increased and new generation had entered this sector to cultivate both in open fields and in protected areas due to the high demand in the local as well as in the export market. Though these crops were available in the market the demand from local consumers were increasing very slowly due to high prices. In addition to the higher prices, most of the consumers may not be aware of the nutritional values of these crops. There is a potential to enhance the incomes of small farmers and create employment for rural labourers by increasing the production, processing and marketing of high value crops.

Any marketable vegetable crop suitable to increase income or reduce income instability of the poor farmers is called “high value” in the context of high value crops (AVRDC, 2007). The present study limited its selection of commodities which had specific potential profitability and substantial nutritional value and had a demand in domestic as well as export market. The wider international demand for high quality out of season fresh fruit and vegetables has led to industry expansion in several least developed countries in Latin America, South-East Asia and Africa (Halam et al, 2004). In their experience, export development had delivered significant impacts in economic growth and poverty reduction through employment and the inclusion of smallholder out growers in the supply chain. Given the sufficient grower interest and technical, financial and commercial support, this experience could be repeated in the majority of the countries of the region where suitable land and adequate water supplies are present to compliment the favourable climate (IFAD, 2008). “Sri Lanka Fruits and Vegetable Producers Processors and Exporters Association” engaged in producing nearly 25 new varieties of high value vegetables such as Bell pepper, Zucchini, Iceberg Lettuce and Butterhead Lettuce which were being produced exclusively targeting niche markets. Model farms and outgrower systems were established and this industry was complemented by pack houses and cold storages in Nuwara Eliya, Bandarawela, Mahaweli system B, C and H, Puttalam and Girandurukotte.

In order to expand this sector, it is vital to understand the value chain. An integral component of the value chain is the agricultural supply chain, because in a value chain marketing system all the stakeholders such as farmers, suppliers and processors are working closely to produce the specific goods to satisfy consumers demand. Therefore, in this system farmers are linked to consumers' needs. On the other hand, consumers

are linked to the needs of farmers through flow of information regarding orders, consumer preferences and so on. It is important that both consumers and traders are made aware of the factors that limit production, and also as much as farmers other producers are made aware of consumer requirements. The market “Pull” is based on integrated transactions and information. Consumers purchase products that are produced according to their preferences. The farmer becomes the core link in producing the products that the consumers desire. Hence under this approach all stakeholders engaging in continuous innovation can benefit. As a result, the returns to farmers can be increased and thereby the living standards can be improved.

1.2 Background

For the detailed study, cauliflower, broccoli, Chinese cabbage, bell pepper and lettuce were selected. Cauliflower belongs to the same family (*Brassicaceae*) of cruciferous vegetables such as cabbage, broccoli and Brussels sprouts. Broccoli is a nutritional super food that strengthens the immune system of humans, helps maintain strong bones, and helps protect from cancer and heart diseases. Lettuce (*Lactucasativa*) is a temperate annual or biennial plant of the daisy family (*Asteraceae*). It is most often grown as a leafy vegetable and the main types include head (iceberg, butterhead, Boston and Bibb), romaine and various leaf varieties. Bell peppers contain no capsaicin. They are high in vitamin C and as they mature and turn colour, vitamin A content rises by a factor of nine while the vitamin C content doubles. The brighter coloured bell peppers tend to be sweeter than green peppers because the sugar content increases as the pepper matures. Peppers are also excellent sources of dietary fibre and provide small amounts of several other vitamins and minerals.

In the urban areas both the supply and demand had increased because the affordable consumers were willing to pay for these vegetables. Rising per capita income in Sri Lanka had stimulated producers and agribusiness entrepreneurs to supply new varieties of high value vegetables to meet the increasing demand in local market as fresh vegetables and in hotels and food stalls as processed food. In addition, demand for these crops has increased gradually in urban areas with the awareness of the nutrition value of the each crop. Vegetables have important components of a healthy diet and it was revealed that sufficient daily consumption of cauliflower and lettuce could help prevent major diseases such as cardiovascular diseases and certain cancers.

During the last decade it was observed that various types of new varieties of high value new vegetables have been cultivated mainly in the Nuwara Eliya, Bandarawela as well as in Dambulla and Kalpitiya areas. These vegetables were supplied to the open market in small quantities compared to that of other exotic vegetables and comparatively a higher quantity was supplied especially to the new supermarket chains, green vegetable outlets, restaurants and for the export market.

Private sector firms and youth producers had entered this sector and cultivated new varieties such as specialized salad greens and other demand-driven high value vegetables previously unknown in Sri Lanka. This growth of a diversified local fresh vegetable supply had extended to poly tunnels by supplying those vegetables throughout the year because it was very important to supply for the export market without any shortages throughout the year. The majority of the population involved in vegetable cultivation were small scale producers or home garden suppliers. While identifying the opportunities in international and local market, the present development programmes are targeted to establish small farm cluster companies/groups linked with exporters or entrepreneurs to expand productivity, promote convenient products, and increase sustainable farm income. The state organizations such as the Sri Lanka Export Development Board along with the Sri Lanka National Chamber of Commerce have launched a project to grow iceberg lettuce in Poly tunnels/green houses in the Nuwara Eliya District in 2008 to increase the lettuce cultivation under poly tunnels/greenhouses targeting the export market. The objectives of that project were to improve quality and productivity, sustainable livelihood development of the rural poor in the area, encourage people for self-employment, improve profitability of the business enterprise, and acquire International standards. *Gamidiriya*, CIC and IFCO also had started cultivating highly perishable high value vegetables to uplift rural farm income.

The Sri Lanka Export Development Board along with the Sri Lanka National Chamber of Commerce had launched a project to grow Iceberg Lettuce in poly-green houses in the Nuwara Eliya District. The objectives of the project were to improve quality and productivity, sustainable livelihood development of the people in the area, encourage people for self-employment, improve profitability of the venture, and acquire standards such as Good Management Practices (GMP) and Good Agricultural Practices (GAP) required for the International Market (www.dailymirror.lk). Vegetables with market potential include salad lettuce, capsicum, broccoli, cauliflower and cucumber (Balapatabendi, 2010). Under IFCO, the cultivation of hybrid varieties such as bell peppers, zucchini, pumpkin and tomato has increased. In addition, they cultivate 14 varieties of lettuce including iceberg, curly, butterhead and lollo rose. International Foodstuff Company (Pvt) Ltd (IFCO) introduced the outgrower system to the farmers in Palwehera, Welimada, Boralanda and Aralaganwilla areas. Consistent farmer educational programmes resulted in an increase in their income level due to the use of modern technology, hybrid seed material and other modern techniques.

According to the IFCO, the export of fruits and vegetables had become the fourth largest revenue earner for the country and has been earning over Rs.3,000 billion annually with a 96 per cent local added value. The Chamber will expand the fruit and vegetable business all over the world since there is a considerable demand for fresh fruits and vegetables. By 2015, the Chamber targets revenue of US\$10 billion and US\$20 billion in 2020. Despite many challenges such as cost of imported fertilizer,

imported hybrid seeds and agro chemicals, work in small units and produce products, Sri Lanka had made a firm entry to the markets all over the world.

The World Health Organisation (WHO)/ Food & Agriculture Organisation (FAO) recommends intake of a minimum of 400 grams (or five servings) of fruits and vegetables per day for the prevention of chronic diseases such as heart diseases, cancer, diabetes, and obesity. A piece of fruit that fits inside a clenched fist or a serving of cooked or raw vegetables, leafy greens similar to the size of the person's fist may also be considered one serving size. While having fruits and vegetables it is important to include a variety of coloured produce because different colours in fruits and vegetables tend to correspond to different combinations of nutrients and other phytochemicals, each with its own array of health benefits. Further, to encourage the younger generation to eat more vegetables these attractive vegetables are very important.

During the last few years it was observed that there was an increasing market demand for the high value highly perishable vegetables with the expansion of the tourist industry and changes of consumption pattern with increased income. Vegetable marketing in Sri Lanka has developed through different retail channels including rural *pola*, collecting centres, wholesale markets, retail shops, catering trade and export market. A gradual increase in investments on this sector could be seen in response to the pricing signals and it led to a competition through rapid changes in supply chain. Through investments competition will increase through efficient food distribution systems.

The concept of agricultural value chain analysis (VCA) has been gaining popularity among agricultural researchers because it has been used to analyse the dynamics of markets and to investigate the interactions and relationships between the chain actors. It also facilitates an improved understanding of competitive challenges among the chain actors. It will help in the identification of relationships and coordination mechanisms among them and assist in understanding how chain actors deal with powers and who govern or influence the chain. Developing value chains is often about improving access to markets and ensuring a more efficient product flow while ensuring all actors in that chain benefit.

The importance of value chain analysis has emerged with the changing food habits and needs of the consumers and the changing agricultural environment in the rural sector. With the increased consumer needs, investment on research and development is enhanced to improve techniques to boost production by focusing consumer needs. In addition to that, research has been done in other areas such as processing, environmental and social cost, health impacts and indigenous knowledge.

The value chain was first developed as a business idea in 1985 by Michael Porter. He defined value chain as “A systematic way of examining all the activities a firm performs and how they interact is necessary for analysing the sources of competitive advantage”. Porter analysed value chains, the activities within and around a firm, but focused on the analysis of the competitiveness of a particular firm. Concepts and analytical tools for analysing the functioning of agricultural value chains are important to understand the impact of chain development interventions on smallholders and the rural poor. In a value chain marketing system, farmers are linked to consumers' needs, working closely with suppliers and processors to produce the specific goods that the consumers demand. Similarly, through flows of information and products, consumers are linked to the needs of farmers.

Global value chain analysis does not focus on the competitiveness of a particular firm, but rather on how relations amongst firms are governed on the efficiency of the chain as a whole. Value chain analysis is emerging as a useful tool that has already led to new practical insights in the markets for fresh fruits and vegetables (Dolan et al., 1999). Recent developments in value chain analysis explained the governance in value chains and related factors and their effects (Gereffi et al., 2003) and the effects of certain governance forms. VCA is used in many countries mainly in private sector development and the main goal of VCA is to accelerate economic growth and poverty reduction.

Value chain analysis (VCA) is a method for accounting and presenting the value that is created in a product or service as it is transformed from raw inputs to a final product consumed by end users (World Bank, 1987). Value chain analysis facilitates an improved understanding of competitive challenges, helps in the identification of relationships and coordination mechanisms, and assists in understanding how chain actors deal with powers and who governs or influences the chain. Developing value chains is often about improving access to markets and ensuring a more efficient product flow while ensuring that all actors in that chain are benefited.

Value chain analysis (VCA) typically involves identifying and mapping the relationships of four types of features: (i) the activities performed during each stage of processing; (ii) the value of inputs, processing time, outputs and value-added; (iii) the spatial relationships of the activities such as distance and logistics; and (iv) the structure of economic agents, such as suppliers, the producer, the processor, the wholesaler and the retailer. Value chains can become complex when they reflect multi-stage production systems with multiple types of firms operating in different locations in one country or multiple countries around the world (FAO, 2007).

Value chain approach can be used to identify failures in sourcing, manufacturing and delivery in the marketing system. Under this approach the researchers will be able to recognize the key public policies such as regulations related to trade, taxes, licensing

and standards, institutional and infrastructure factors and underlying constraints in the business environment. These factors will show a significant impact on the competitiveness. Market based value chain identifies the priority areas to reform the business and helps to redesign policies for the solutions within the specific environment.

In the value chain approach three main areas such as product market issues, factor market issues and market related issues come out. Product market issues cover trade policy, competitiveness, price distortions, subsidies, licensing, product standards, customs, logistics, property rights, trade regulations and so on. Factor market issues are wages, capital charges, utility market issues, labour market rigidities, land price and zoning etc. Market related issues cover market diversification, research and development, product diversification and supplier linkages etc. (FIAS, 2007).

Agriculture can be a major driver of growth and development in Sri Lanka since it offers food security, income diversification, increased national productivity and creation of new jobs while practicing in the correct way. To achieve this agriculture should be converted to agribusiness. In the past as well as the present many of the stakeholders have not really been pursuing agriculture as a business. There are many challenges such as low yields and low quality of produces, limited access to credit, and limited facilities for storage, packaging, processing and distribution to its final destination that is the market to consider agriculture as a viable business. Commercial agriculture is the best way to achieve our goals in agriculture. In commercial agriculture, it is necessary to link the producers to critical value chain institutions to achieve the maximum capacity of them. This effort ultimately will provide market for agricultural commodities. Then the stakeholders will think about the aspects of the value chain. This is production, transport, processing, storage and supply management. When all these activities are integrated, it is called market-oriented approach or the value-chain approach. The stakeholders in this sector lose their earnings due to post harvest losses. To overcome these problems it needs processing. Now it is understood that income of farmers cannot be increased from mere production. They can earn more from value addition. When the stakeholder adds value through agro industrialization, he will reap the full benefit of the investment. Also the buyers are looking for better grades of what they produce, and the allied issues of packaging and the rest will come in. Virtually, this is the value chain - production, storage, processing, packaging and marketing.

In the past, increased production, processing, and marketing of vegetables have changed the status of stakeholders to some extent. It is understood that there is a potential to enhance the incomes of small farmers and create employment for rural and urban poor in the country, and also to provide nutritional benefits to poor consumers. By expanding the sector it will create new opportunities for the rural and urban poor in all aspects of the commodity chains of high value crops, from

production, through processing, transport and marketing, to consumption. In order to generate improvements in the supply or quality of any product, one needs to consider all aspects of a range of steps in the chain of events from production to consumption, including both opportunities and constraints and the demand and supply of necessary products and services.

Taking value chain approach to economic development and poverty reduction involves addressing the major constraints and opportunities faced by farmers and producers, processors, traders and other businesses at multiple levels, it points along a given value chain. This will inevitably include a wide range of activities such as ensuring access to the full range of necessary inputs, facilitating access to cheaper or better inputs, strengthening the delivery of business and financial services, enabling the flow of information, facilitating improved market access, or increasing access to higher-value markets or value-added products. Hence a value chain is a connected string of companies, groups and other players working together to satisfy market demands for a particular product or group of products.

The value chain approach is used mainly for private sector development and the main goal is to accelerate economic growth and poverty reduction. Many countries use a participatory, stakeholder-driven approach to make use of opportunities for investment and growth in industries with high levels of micro and small enterprise involvement. Sri Lanka is also practicing this and it helped enhance this sector.

The value chain approach analyses the firms in a market chain and the relationships among the stakeholders from input suppliers to final consumers or buyers. It analyses the factors influencing industry performance, including access to and the requirements of end markets; the legal, regulatory and policy environment; coordination between firms in the industry; and the level and quality of support services. Relationships among firms in an industry can facilitate production and marketing efficiencies and enable the flow of information, learning, resources and benefits.

In the agricultural policy document, goals related to this sector in the country are ensuring higher and sustainable income for farmers, introducing efficient farm management techniques and to produce the required vegetables for the consumers and for the hotel trade.

1.3 Problem

During the last few years agribusiness in the vegetable subsector has grown with higher prices and better profit margins. As a result, some of the farmers reinvest their income for these new vegetables to earn higher profits by reducing the cultivation of less profitable traditional types of vegetables. The highly perishable vegetables are marketed at high prices and the margin between wholesale price and retail price is

very high. As this sector has shown the gradual growth a market survey will be beneficial to assess the needs and assist agribusiness to fill the unmet market demand in this vital part of the vegetable sector.

The value chains in this sector were not studied. Under this sector there were many crops cultivated and marketed. Only a few varieties were available in the domestic market and they were very expensive. It was observed that though the supply increased, the demand from domestic consumers did not increase. For the expansion of this sector domestic demand also should increase. It was necessary to collect data and information on production and marketing of the highly perishable high value vegetables which were lacking at the moment. Therefore, it is important to study this vegetable sub sector and analyse the price structure of these vegetables to find out the value addition with the cost and profit margins and to find out the constraints faced by the actors in the value chain. It will be helpful to find out whether there is a potential to expand incomes along the whole supply chain from farmer to consumer and increase the turnover.

1.4 Objectives of the Study

The purpose of the study was to review the overall situation of high value highly perishable crops in the vegetable sub sector of Sri Lankan agribusiness and to identify, assess, and prioritize constraints and also to find out the remedial measures and crosscutting policy reforms to enhance competitiveness, growth, employment, and business opportunities in the country. To maximize the market potential of this highly important sector, it is necessary to understand all the elements related to it. Therefore, this study should provide input as the basis to design a development strategy for the rational economic growth.

The study's specific objectives were as follows:

1. Review the present situation of this sector
2. Assess the performance of farmers involved in the production of highly perishable high value vegetables using a value chain analysis
3. Find out the constraints faced by the chain actors
4. Examine the challenges and opportunities for increasing access to the regional and global markets for the products and associated inputs
5. Suggest measures to overcome the constraints to develop this sector.

1.5 Methodology

In line with the objectives of the study, the methods of data collection consisted of three major components; viz. including a comprehensive literature review and collection of secondary data available in the country, a survey to interview all the chain actors and related key informants, and value chain analysis done using the primary data. The field visits were scheduled to gather information from cultivation under open fields and within protected houses such as poly tunnels. The leading collectors in Uva Paranagama and Nuwara Eliya provided their data bases for the analysis. By using those data the researcher was able to identify the producers as well as traders in these areas.

This study adopted a holistic commodity chain approach considering the interests of producers, collectors, transporters, wholesale and retail traders, exporters and consumers. Products were identified at the main urban markets and wholesale markets in main vegetable producing areas. Then the producers and regional collectors were found going through the commodity chains adopting the participatory market chain approach. Important recent methods were used to analyse commodity chains, such as value chain mapping. At least five stakeholders at each level were interviewed to collect data. Accordingly the high value vegetable crops and their market chains were identified with their unique characteristics. It was identified that they were location specific. The traders assemble a range of crop species and cultivars through commodity chains and locations relevant to the poor.

Data and information on production and marketing were collected to identify, assess, and to prioritize constraints and to find out remedial measures.

The boundaries of the vegetable subsector subjected to this value chain analysis were as follows:

1. Farmers: Fresh vegetables producers in Nuwara Eliya and in Uva paranagama in Bandarawela
2. Consolidation of processing sector: application of quality standards, investments in modern technologies for processing and packaging, product branding.
3. Services provided in support of the subsector: input supply, extension and advisory services, logistics and transportation, trade, marketing and retail.

Subsector products included in this analysis were highly perishable fresh vegetables with high profit margins, such as lettuce, Chinese cabbage, Cauliflower, broccoli, iceberg, Pak Choy, zucchini, green cucumber, tomato and bell pepper and those are

produced in open fields and within protected houses such as poly tunnels and green houses.

1.6 Structure of the Report

The study begins with a review of the high value highly perishable vegetable cultivation, production and marketing in the country. In Chapter Two the sub sector, the supply channels and the dynamics are analysed and value chain is analysed in Chapter Three. Chapter Four discusses the constraints faced by the chain actors such as growers, traders, exporters and consumers. The study is completed by presenting the strategies for sub sector and value chain development and recommendations in the Chapter Five.

CHAPTER TWO

Overview of the High Value Vegetable Sub Sector

2.1 Introduction

The diverse agro ecological zones of Sri Lanka are well suited for cultivation of different kinds of vegetables. Officers in the agricultural sector and also farmers selected many crops to grow in these areas. The Department of Agriculture has provided training on cultivation practices and packaging systems too. High value vegetables such as bell pepper, tomato and green cucumber are grown under protected agriculture. Other high value vegetables are grown in the open field. The most common crops are iceberg, cauliflower, broccoli, Pak Choy, lettuce and many varieties of herbs. Except for cauliflower and broccoli all the selected crops are cultivated as mixed crops in the field. At the initial stage, these crops were cultivated by targeting the export market. Later the demand increased from hotels and supermarkets too. At present the demand has increased slightly from consumers in the urban cities. Due to highly perishable nature of these vegetables the supply chains are kept very short to maintain the freshness.

Vegetables can be consumed cooked or uncooked according to the taste and aroma. Although all the vegetables are perishable by nature, some of them are highly perishable. Hence these vegetables should be consumed within a day from being harvested or should be kept in a cooler environment for later use. Some of the highly perishable high value vegetables are consumed in cooked state. Some of them are cauliflower, broccoli, Chinese cabbage and Pak Choy. Vegetables that are consumed uncooked are called salad crops. Salad crops are now very popular because of their food value in the diet. The Sri Lankans use many types of vegetables in preparation of salads. In addition to that, some other vegetables such as lettuce, celery, red cabbage, parsley and bell pepper are used to make salads and these vegetables are very expensive compared to that of other vegetables such as carrot, tomato and cucumber.

2.2 Development of the Crop Sector

To increase the farm income in the Uva Province these crops were introduced to the farmers in the area. About 70 per cent of the rural population faced problems of finding water for vegetable cultivation. As a solution, new technology was introduced with new crops. Farmers have mentioned that this innovation improved their livelihoods. According to the Department of Census and Statistics (2007), about 70 per cent of the rural population in the province depend on agriculture for their livelihood. The highest percentage of population under poverty line was recorded in the Uva Province among all the provinces in the 1995/96 survey of the Department of Census and Statistics (40.2%). Poverty reduction can be observed with the available data (31.8). This indicates

that poverty reduction can be done by upgrading the income of the rural population. Hence new crops were introduced to the farmers in the Uva Paranagama area.

Sri Lanka Fruit & Vegetable Producers, Processors and Exporters Association with the support of the Sri Lanka Export Development Board (SLEDB) intervened to develop the vegetable sector by introducing about 25 new varieties of high value vegetables such as Bell Pepper, Zucchini, and Iceberg and lettuce varieties such as romaine and butterhead lettuce using Hybrid seeds, poly tunnel technology, drip irrigation and fertilization methods.

To increase the farm income of the poor farmers in the Uva Paranagama area, vegetable cultivation under new improved techniques was introduced by one of the political leaders in the area in 2004. The main crop introduced was bell pepper and later on farmers entered the cultivation of other related high value crops. Accordingly these farmers cultivate bell pepper and tomato in poly tunnels and iceberg, lettuce, Pak Choy, basil, Chinese cabbage etc. in the open field. This crop sector was introduced in 2004 and it popularized among farmers very slowly because farmers were reluctant to take the risk of cultivation due to lack of awareness on cultivation and market demand. About 50 farmers entered this crop sector in 2009. From 2009 to 2010 it has spread among 102 farmers by indicating 85 per cent improvement. From 2010 to 2011 about 32 farmers entered this crop sector and it was a 32 per cent improvement compared to 2010. According to the available information, the number of farmers engaged in this crop sector was more or less stable in the Bandarawela area. Though the number of farmers is stable, their cropping extent has increased by building new poly tunnels.

In Uva Paranagama area 100 poly tunnels were distributed among poor farmers in the area. Those poly tunnels were built using the Indian technology. Out of those 100 tunnels 75 are used for bell pepper and tomato cultivation. At present about 400-500 young farmers cultivate bell pepper and tomato under poly tunnels. According to the traders there are about 800 poly tunnels of 1000sq feet in the area. Most of the farmers used wooden frames to build poly tunnels to minimize the cost. Youth entered this trade and the cost of construction of 1000sq feet poly tunnel is about Rs.110,000. It needs about Rs.20,000 capital investment for drip irrigation system. Other material cost is about Rs.30,000. The growing media of bell pepper is filled in a polythene bag which is about 15 inches in height and 14 inches in width. It is filled with more compost than the compost mixture prepared for cucumber because cucumber needs more water.

Farmers in Sapugolla, Nakadiya, Ambagasdowa, Pallewela, Unapana and Udukumbura areas in Uva Paranagama cultivate these high value vegetables. Their farm income has increased with the increased demand from wholesalers and tourist hoteliers located in various towns in the country. However, some farmers face many problems in transporting their produce to the market due to lack of motorable roads.

2.3 Cultivation Practices

These vegetables are cultivated in very small land areas and farmers use various methods to maximize their profit. The poly tunnel farmers remove all soil bags after harvesting a crop and use disposed soil to cultivate cucumber in the open field. Most of the farmers cultivate iceberg in the open field and intercropped with Pak Choy and lettuce. Farmers who have good experience in cultivation of cabbage replace their crop with red cabbage and Chinese cabbage. Some of the farmers who cultivated potato also replace their cultivation with these vegetables. They use the land for mixed cropping and prepare for year - round supply.

Farmers are aware that these crops need a humus-rich, moisture-holding, well-drained soil which is abundant in leaf-producing nitrogen. Some of the farmers use cow dung and many of the farmers use compost. They said that when cow dung is used the soil is subject to worm attacks in addition to weeds. To protect the crop more agro chemicals have to be used. Irrespective of the type of fertilizer used they apply agro chemicals. The agro chemical companies mentioned that only safe chemicals are introduced for these leafy vegetables. In the land preparation stage the growers apply lime to soil to destroy worms and pests.

2.3.1 Lettuce and Pak Choy Cultivation

Lettuce Cultivation

Lettuce is very famous among the vegetable farmers and they used to cultivate lettuce since this crop can be grown easily. There are about 150 varieties available in the world and our farmers also cultivate about 20 varieties. There are four distinct types of lettuce available in the country and they are called head, leaf, COS or romaine and asparagus. These four lettuce varieties can be recognized as follows.

Head Lettuce

Head lettuce can be recognized by its compact round head of leaves and these varieties are often the mildest in taste. They are often valued for their tender texture and crunchy taste. The head lettuce is divided into two categories named crisp head and butter head. There are some common varieties coming under this category and they are Iceberg lettuce, Butterhead lettuce and Bibb lettuce. Iceberg lettuce has the most compact head of leaves while Butterhead lettuce has the least compact head, followed by Bibb lettuce. Both Butterhead and crisp types have cabbage- heading varieties and bunching varieties.

Cos or Romaine Lettuce

This kind of lettuce is known to be the most nutritious and is recognized by elongated leaves that grow outwards unlike the head variety that grows inwards. The leaves are often bunched together. Some may even consider it as the tastiest variety. This variety of lettuce has an enormous amount of antioxidants and cancer fighting substances. It is

also considered good for improving the immunity. There are many varieties of Romaine lettuce such as Parris Island and Red Romaine. Parris Island Cos Lettuce is one of the most common romaine lettuces that are grown in Sri Lanka too. Farmers identified this crop as Chinese cabbage and its leaves are crispy and sweet in flavour. Uniform heads are large and the average height is about 10 inches. Its outer leaves are green and inner leaves are white and yellow. This crop matures 70-75 days after planting.

Leaf Lettuce

Leaf lettuce produces a cluster of leaves which grow outwards. The leafy ones grow the fastest and are often preferred by many growers who wish to grow vegetables. Apart from being rich in calcium and other minerals as many other varieties of lettuce, it is also rich in organic oil.

Asparagus Lettuce

This variety of lettuce draws its name from its thick stalk, which is cooked and prepared in ways similar to asparagus. A very common type of asparagus lettuce is valued for its leaves as well as the stalk. Though it tastes bitter they can be used in salads when harvested in a younger stage because at this stage it is very crunchy and tasty.

Almost all these lettuce varieties are very productive and farmers earn well from a very limited space. According to their experience they select the suitable land where the soil drains well and retains some moisture. As this is a leafy vegetable the soil should be rich in nitrogen and potassium. Therefore farmers in Nuwara Eliya use more organic matter compared to Uva Paranagama.

Almost all farmers maintain nurseries and are engaged in constant transplanting to yield a maximum production and to meet the supply orders continuously. Farmers are aware of the planting techniques and they complained about the germination of seeds. The literature showed that the lettuce seeds will not germinate in soil that is 80⁰F or warmer. There are some heat tolerant varieties in major producing countries to grow in summer. A team of researchers in University of California and Arcadia Biosciences and Acharya N.G. Ranga Agricultural University India has identified a lettuce gene and related enzyme that put the brakes on germination during hot weather. This discovery will be a relief to lettuce growers as lettuce seeds can sprout year-round, even at high temperatures. This is a very vital discovery in vegetable seed industry to overcome the emerging problems of vegetable production with rising global temperatures.

Seeds are planted ¼ inch deep and watering is done to maintain the moisture level in the land. Farmers apply compost to help soil retain moisture. The spaces between seedlings are varied according to the variety. In general they keep about 6 inches apart. Well experienced farmers do intercropping with broccoli, carrot, leeks, red cabbage, beet root etc. because most of the lettuce varieties mature in 45 to 55 days and without an extra effort these crops can be harvested. Hence almost all the farmers grow two three other crops as intercropping. The loose-leaf and butterhead leaves can be

harvested at any time in their development according to the demand. Heading varieties take a longer time to mature. Romaine lettuce takes about 75-85 days and Crisp head lettuce takes about 70 - 100 days to mature.

Lettuce is generally a disease and pest free crop. But cutworms and slugs are the most bothersome pests in the field. The major threat is lettuce rot and it first attacks the lower leaves of the plant as the lower leaves touch the soil and then spreads throughout the plant. Farmers apply agro chemicals to protect the crop at this stage. They are aware of crop rotation and some of the farmers believed that this is a good method to prevent fungal and bacterial diseases. In addition they stated that these crops cannot be grown in the same plot for two years consecutively.

Lettuce can be harvested at any time after true leaves form. Early harvest produces best quality products. When the matured plants remain in the field for a long period the leaves give out a bitter taste and tough. Some farmers remove the whole plant and some of them cut the plant at the soil level. All farmers harvest lettuce in the morning and at this time leaves are crispy, sweet, fresh looking and very attractive. Farmers have experience in selecting the matured plants by the appearance. When the plants are over matured the flower stem will come out and these plants have no value in the market. The following chart shows the tips for lettuce cultivation.

Tips for lettuce cultivation

Expected germination time	6-12 days - germination is irregular in hot weather If the temperatures are over 80 degrees, the seeds won't grow.
Life expectancy of stored seed	2-3 years
Approximate time between sowing and harvesting	8-14 weeks (Butter/Crisphead & Cos Varieties) 6-8 weeks (Loose leaf Varieties)
Cultivation evidence	Not difficult, sown properly and watered often. keep the soil moist, but not damp Rotate the crops – Growers don't plant lettuce where they cultivated in previous year, or the year before. Spray the plants with compost tea or similar fertilizer every two weeks. This also helps protect against many of the fungal diseases that can occur when growing lettuce. Slugs and snails are often attracted to lettuce. To trap them farmers place a shallow pan in the lettuce patch filled with beer. And also they sprinkle wood ashes around the plants. During hot temperatures the leaves become bitter.

Spacing between lettuce plants varies according to the variety. Leaf lettuce types required 6 inches apart with 12 inches row spacing; iceberg lettuce required 12 inches apart with 18 inches row spacing; Romaine lettuce plants need 8-10 inches apart with 12-16 inches row spacing and Butterhead/Batavia lettuce need 10-12 inches apart with 12 inches row spacing. Leaf Lettuce can be harvested when it is considered large enough to use. When harvesting lettuce, it is advisable to cut other plants by providing more room for the remaining crop. This variety usually reaches maturity in 50 to 60 days. Butterhead type is usually ready for harvesting in 60 to 70 days. The most inward leaves have the tendency to pale providing a real delicacy. Romaine types have upright growing habits and develop an elongated, medium-dense head. Storage of lettuce should include washing, drip drying and placement in a plastic bag in the refrigerator.

Various types of lettuce are cultivated by Nuwara Eliya farmers. Comparatively lettuce cultivation in Nuwara Eliya is higher than that in Uva Paranagama area. Farmers in Uva Paranagama area mentioned that the climate in that area is good for iceberg and Pak Choy. They have dropped cultivation of romaine lettuce and cultivate other high value crops. Nuwara Eliya farmers cultivate romaine lettuce as intercropping with carrot, leeks, beetroot and cabbage. Other high value lettuce varieties are cultivated by very few farmers in Meepilimana area. They have clearly identified the demand for each type of lettuce and have done cultivation as mixed cropping. The farmers who have gained experience of cultivation and marketing started to produce seeds by themselves. Seeds of common lettuce varieties are available with seed distributors.

There are many varieties of lettuce cultivated in Nuwara Eliya and many farmers grow leaf lettuce. Green leaf variety is the common crop cultivated in almost all farm lands. But other uncommon lettuce varieties are cultivated in very limited farm lands because these crops have a very specialized market. Approximate time between sowing and harvesting for loose leaf varieties are 6-8 weeks and for butter, Crisp head and cos varieties are 8-14 weeks. Both head lettuce (iceberg and butter head) and leaf lettuce (green leaf, romaine and red leaf) are grown for both local and export markets. The average farm size in Nuwara Eliya and Bandarawela is about $\frac{1}{2}$ ha -1ha with the average lettuce field size is about $\frac{1}{4}$ ha. The majority of growers plant green leaf lettuce along with other varieties throughout the year to gain an extra income by paying an extra effort to meet the fluctuating demand. Most of the farmers cultivate three to four crops of iceberg and green lettuce per year in staggered plantings because farmers are aware of the daily demand of each crop. Many of the farmers in Uva Paranagama grow iceberg lettuce followed by other high value crops such as Chinese cabbage, celery or red radish. These farmers grow Pak Choy along with other crops such as iceberg, Chinese cabbage, basil and cucumber. Depending on the variety and the weather conditions maturity period varies. Crop can be harvested $1\frac{1}{2}$ - $2\frac{1}{2}$ months after transplanting and direct seeding. Large scale farmers and farmers who have good experience in producing these crops represent vertical integration by taking over all the functions of marketing from

seed and other input supply, processing, distribution and marketing between farmer and consumer.

Pak Choy

Farmers in Uva Paranagama cultivate Pak Choy in their fields with other crops such as iceberg and basil to gain an extra income. Pak Choy is planted on the edge of the vegetable beds and the common variety is green leaf with white stems. Pak Choy is a versatile plant that can be cultivated as a cut-and-come-again (CCA) crop or harvested as a mature plant. The Sri Lankan farmers harvest this crop after it matures as a whole plant and it takes about 6 weeks. Generally it can be harvested within two months.

Farmers plant these seedlings about 4- 8 inches apart. As Pak Choy has shallow roots it needs very little water. Pak Choy is susceptible to the entire attack of brassica ailments such as flea beetle, aphids, cabbage white fly, caterpillars, root fly, slugs, snails and birds.

Table 2.1: Top Ten Lettuce and Chicory Producing Countries – 2010

Country	Production (tonnes)	As a % of Total Production
China	12,574,500	53.2
United States	3,954,800	16.7
India	998,600	4.2
Italy	843,344	3.6
Spain	809,200	3.4
Japan	537,800	2.3
Iran	402,800	1.7
France	398,215	1.7
Turkey	358,096	1.5
Mexico	340,976	1.4
World	23,622,366	100.0

Source: FAO Statistics Division 2011

According to the FAO statistics the leading producer of lettuce and chicory is China followed by the USA. These two countries produce about 70 per cent of the world production. As India also produces large quantities some of the leading exporters are used to purchase these produces to deliver for their export orders.

Almost all the farmers have the idea of daily requirement of each crop and the ordered quantity of each collector. They know that they cannot sell these crops in the open market because still there is no good demand created from other common vegetable traders. The largest quantity of iceberg lettuce is purchased by fast food processing companies and supermarkets. Farmers are aware of the ordered quantity and the

quality of the produce they require. They harvest the crop accordingly to retain the freshness.

The leaves of loose leaf lettuce wilt quicker than head lettuce varieties. To enjoy the real flavour of lettuce it has to be consumed soon after harvesting. The tourist hotels mix various types of lettuce which are crispy, crunchy and soft smooth types to capture attraction and to offer a tasty salad bowl. The following nutritional information is for one serving of iceberg lettuce (55g) and butterhead lettuce (100g). That would be about one cup of chopped or shredded iceberg lettuce, or 55 grams. This general information is for raw butterhead and iceberg lettuce.

Table 2.2: Nutritional Value per 100g of Butterhead Lettuce

Nutrients	Nutritional value per 100g
Energy	55 kJ (13 kcal)
Carbohydrates	2.23 g
Sugars	0.94
Dietary fibre	1.1 g
Fat	0.22 g
Protein	1.35 g
water	95.63 g
Vitamin A equiv.	166 µg (21%)
- beta-carotene	1987 µg (18%)
- lutein and zeaxanthin	1223 µg
Thiamine (vit. B1)	0.057 mg (5%)
Riboflavin (vit. B2)	0.062 mg (5%)
Pantothenic acid (B5)	0.15 mg (3%)
Vitamin B6	0.082 mg (6%)
Folate (vit. B9)	73 µg (18%)
Vitamin C	3.7 mg (4%)
Vitamin E	0.18 mg (1%)
Vitamin K	102.3 µg (97%)
Calcium	35 mg (4%)
Iron	1.24 mg (10%)
Magnesium	13 mg (4%)
Manganese	0.179 mg (9%)
Phosphorus	33 mg (5%)
Potassium	238 mg (5%)
Sodium	5 mg (0%)
Zinc	0.2 mg (2%)

Source: USDA Nutrient Database

Percentages are relative to US recommendations for adults.

Table 2.3: Nutrient Composition of Iceberg Lettuce

Macronutrients	Nutritional Value per 55 g
Water:	52.60 mg
Calories:	8
Protein:	0.5
Carbohydrates:	1.63 g
Fibre:	0.7 g
Sugars:	0.97 g
Total Fat:	0.08 g
Saturated Fat:	0.010 g
Monounsaturated Fat:	0.003 g
Polyunsaturated Fat:	0.041 g
Cholesterol:	0 mg
Micronutrients:	
Calcium:	10 mg
Iron:	0.23 mg
Magnesium:	4 mg
Phosphorus:	11 mg
Potassium:	78 mg
Sodium:	6 mg
Zinc:	0.08 mg
Vitamin C:	1.5 mg
Thiamin:	0.023 mg
Riboflavin:	0.014 mg
Niacin:	0.068 mg
Pantothenic Acid:	0.050 mg
Vitamin B6:	0.0230 mg
Vitamin B12:	0 mcg
Folate:	16 mcg
Vitamin A:	276 IU
Vitamin E:	0.10 mg
Vitamin K:	13.3 mcg
Phytonutrients:	
Phytosterols:	6 mg
beta Carotene:	164 mcg
beta Cryptoxanthin:	0 mcg
Lycopene:	0 mcg
Lutein and Zeaxanthin:	152 mcg

Source: USDA National Nutrient Database for Standard Reference
g= gram; mg=milligram; mcg= microgram; IU=International Unit

2.3.2 Cauliflower and Broccoli Cultivation

Cauliflower and broccoli are grown from seeds and the nursery beds are prepared for growing of seedlings. The seeds are sown in well-drained seed beds of a deep and thoroughly cultivated fertile soil. About three weeks before sowing, the seedbeds are soaked with fungicides or sterilized with lime especially when sown during the rains. Nuwara Eliya farmers add more farmyard manure or cow dung manure than that of Uva Paranagama famers. They add organic manure before applying fungicides. Under normal conditions the seeds germinate within 3-4 days and rapid germination avoids the chances of attack by soil microorganisms. Therefore farmers pay their maximum effort to protect seedlings. Farmers cultivate about 100 – 200 grams of cauliflower or broccoli seeds at once. Soil is prepared well by applying manure and fertilizer as the basal dose before transplanting.

The size of the beds and the number of rows to be planted between the drainage furrows is varied according to the natural drainage of the land and the presence of fixed irrigation lines. The size of the beds varies from the large one having 3-4 rows to single or double row beds. Many farmers prefer double row beds because then it is easy to take care of plants. Row and plant spacing is about 6.5 X 6.5 cm. Farmers transplant the seedlings which are 3-4 weeks old and the plants have 4 - 6 leaves. They said that these seedlings gave better yields with good quality. According to their experience the yield and the quality of cauliflower curds and broccoli are low when the transplanted seedlings are grown more than 3-4 weeks. Just after transplanting the seedlings are irrigated because cauliflower and broccoli are low rooted crops and furrow irrigation is the most common method used by Nuwara Eliya farmers. Generally, cauliflower and broccoli are irrigated every 3-5 days. At the time of head formation the moisture level in the field is very important to get the best quality produce. Hence farmers irrigate the field as required. After transplanting farmers always keep the crop free from weeds. During cultivation it is necessary to apply fertilizer and plants are earthed up to provide stability to plants. During the rainy season more attention is paid for crop management. Well experienced farmers who sell their cauliflower at higher prices to the exporters always try to produce good quality curds. Hence they do blanching to protect the heads from sun burning and yellowing. As a result of blanching, the curds can maintain the taste and a very attractive appearance. The farmers place a cauliflower leaf over the head to protect from the sun because the yellow colour curds fetch low prices in the market. According to the variety heads are ready to be harvested in 60-70 days, 90-100 days and 120 days after transplanting.

Cauliflower and broccoli plants produce a big flower which is the edible portion known as curd. It is made up of abortive flowers, the stalks of which are short, fleshy and closely crowded. The colour of cauliflower curd is white or light yellow white while that of broccoli is green.

Table 2.4: Nutritional Value of Cauliflower per 100g

Principle Nutrients	Nutrient Value	Percentage of RDA
Energy	25 Kcal	1%
Carbohydrates	4.97 g	4%
Protein	1.92 g	4%
Total Fat	0.28 g	1%
Cholesterol	0 mg	0%
Dietary Fibre	2.0 g	5%
Vitamins		
Folates	57 mcg	14%
Niacin	0.507 mg	3%
Pantothenic acid	0.667 mg	13%
Pyridoxine	0.184 mg	14%
Riboflavin	0.060 mg	4.50%
Thiamin	0.050 mg	4%
Vitamin A	0 IU	0%
Vitamin C	48.2 mg	80%
Vitamin E	0.08 mg	0.50%
Vitamin K	15.5 mcg	13%
Electrolytes		
Sodium	30 mg	2%
Potassium	299 mg	6%
Minerals		
Calcium	22 mg	2%
Copper	0.039 mg	4.50%
Iron	0.42 mg	5%
Magnesium	15 mg	3.50%
Manganese	0.155 mg	7%
Zinc	0.27 mg	2.50%
Phyto-nutrients		
Carotene-β	0 mcg	--
Lutein-zeaxanthin	1 mcg	--

Source: USDA National Nutrient data base

Cauliflower and broccoli can be stored in open for 2-3 days. In the marketing process these produces need to be handled with care because they are tender and liable to damage easily. Hence the farmers do not trim the leaves and use those as packing material. The cauliflowers are sorted at the field level and packed in cardboard boxes and plastic crates. The leaves are cut 2-2.5cm above the head to minimize damage.

Both cauliflower and broccoli have become very popular vegetables and they have a profitable market in the country. The farmers have also identified that these crops are highly profitable. The farm income varies on certain factors such as variety, locality and the season as well as labour availability.

Cauliflower and broccoli were widely available in Nuwara Eliya. Cauliflower cultivation has spread in Kandy, Matale and Puttalam districts too while broccoli cultivation is still limited to Nuwara Eliya area. As a result, the price of cauliflower has dropped considerably. Hence Nuwara Eliya farmers reduce cultivation of cauliflower and increased cultivation of broccoli. According to the farmers in Dambulla area, cultivation of cauliflower has increased considerably in the last two years as some of the cabbage farmers in Kalundewa, Angulwelpessa, Kalogahaela, Galpoththayaya and Thalawellanda have started cultivation of cauliflower to gain a higher income. Though the recorded database was not available it was revealed that about 15 acres of cauliflower are cultivated in these areas by about 30 farmers. Nearly 25 farmers have cultivated ½ acre land and two farmers cultivated one acre of land. Others cultivated ¼ acres. In Moragaspitiya and Akuramboda areas 10 and 6 farmers were identified respectively. According to the farmers, the cultivation cost is about Rs.125,000 – Rs.135,000 per ½ acre and about 4000- 5000kg can be harvested. According to that the cost of production varies from Rs.25.00 to Rs.31.25 per kg. The producer prices and wholesale prices of cauliflower in the above mentioned areas of Dambulla and DEC in Dambulla respectively in 2012 are shown in the Table 2.5 below.

Table 2.5: Weekly Producer Prices and Wholesale Prices of Cauliflower in Dambulla

Month	Producer Price Range (Rs/kg)		Wholesale Price Range (Rs/kg)		Average Prices (Rs/kg)		Margin (Rs/kg)	Mark up %
					Producer	Wholesale		
May -w1	97.00	100.00	100.00	105.00	98.50	102.50	4.00	4.1
w2	82.00	95.00	85.00	98.00	88.50	91.50	3.00	3.4
w3	77.00	92.00	80.00	95.00	84.50	87.50	3.00	3.6
w4	75.00	87.00	78.00	90.00	81.00	84.00	3.00	3.7
Jun w1	72.00	83.00	75.00	85.00	77.50	80.00	2.50	3.2
w2	60.00	67.00	62.00	70.00	63.50	66.00	2.50	3.9
w3	43.00	55.00	45.00	57.00	49.00	51.00	2.00	4.1
w4	40.00	48.00	42.00	50.00	44.00	46.00	2.00	4.5
Julw1	35.00	44.00	37.00	45.00	39.50	41.00	1.50	3.8
w2	33.00	40.00	35.00	42.00	36.50	38.50	2.00	5.5
w3	25.00	30.00	27.00	33.00	27.50	30.00	2.50	9.1
w4	28.00	33.00	30.00	38.00	30.50	34.00	3.50	11.5
Augw1	35.00	46.00	38.00	48.00	40.50	43.00	2.50	6.2
w2	38.00	48.00	40.00	50.00	43.00	45.00	2.00	4.7
w3	43.00	53.00	45.00	55.00	48.00	50.00	2.00	4.2
w4	50.00	58.00	52.00	63.00	54.00	57.50	3.50	6.5
Sepw1	55.00	67.00	57.00	70.00	61.00	63.50	2.50	4.1
w2	58.00	67.00	60.00	70.00	62.50	65.00	2.50	4.0

Source: Survey data 2012

The crop comes to the market in May and the peak harvesting season lies in July to August. During that period the producer prices and wholesale prices had dropped below Rs.45.00 per kg. The lowest prices were reported in third week of July and the gross margin between producer price and wholesale price was Rs.2.50 per kg. Farmers harvest cauliflower in the early morning and pack the produce in cardboard boxes very carefully. A box can contain about 25kgs of cauliflower. The farmers are very concerned about the quality of cauliflower because the damaged curds have very low value.

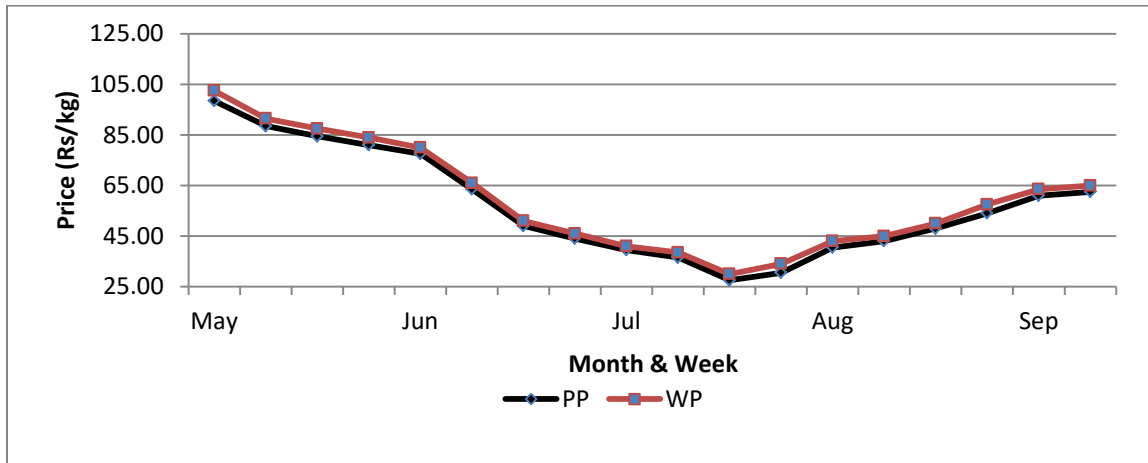

Source: Survey Data, 2012

Figure 2.1: Average Producer Prices and Wholesale Prices of Cauliflower in Dambulla

Nuwara Eliya farmers reduce cultivation of cauliflower because there is a large supply of cauliflower marketed from Kandy area. Though these flowers are very small there is a good demand from hotels due to low price. The farmers in Kandy cultivate cauliflower in paddy fields. Hence their cost is comparatively lower than that of Nuwara Eliya farmers.

In Sri Lanka a very limited supply of these crops is available throughout the year and a larger supply can be seen especially in February - March and July - September. Most of the Indian cultivars of cauliflower are marketed by the name of Hindi month they mature in, such as *Kunwari* (September -October), *Katiki* (Oct. -Nov.), *Aghani* (Nov. - Dec.), *Poosi* (December) and *Maghi* (January). A number of improved cultivars have been released by various research organizations on the basis of their superior performance. Therefore to capture the export market our country has to plan the cultivation properly in accordance with the above mentioned seasons.

2.3.3 Cucumber Cultivation

Dark green cucumbers are grown in open field in Uva Paranagama area and farmers call it salad cucumber. Seeds are sown directly in the open ground by placing 2 seeds per

each hole and 80cm apart each way. Fruits are cut regularly to support the plant to produce lengthy and continuous production. Fruits are harvested in their younger stage before producing seeds. Almost all the farmers harvest cucumber in the early morning when it is fresh and cool. It was found out that cucumbers contain 96 per cent water and they are low in calories but high in potassium. As the dark green skin is rich in carotenoid antioxidants the scientists advise not to peel off the skin.

2.3.4 Bell Pepper Cultivation

Bell pepper cultivation is carried out under poly tunnels, a non-traditional cropping arrangement in the Uva Paranagama area. According to the farmers, bell pepper plants are easy to cultivate and production can be obtained throughout the year. This can help the exporters to supply bell peppers during the lean periods of the other exporting countries where bell peppers are grown in the open field. The cultivation under poly tunnels is very costly because the construction of poly tunnel and preparation of pots are fairly expensive. But the farmers in Uva Paranagama area construct poly tunnels using wooden bars instead of iron poles to cut down the cost. Considering the total investment, 75 per cent is for construction and 25 per cent is for preparation of pots and other requirements.

Table 2.6: Cost of Construction of a Poly Tunnel and Planting Pots (Rs)

Item	Unit	Price	Value	Value
U V Polythene	17 m ²	190x17x8	25,840	25,840
Timber for Frame		600x58	34,800	
Transport & other			13,000	47,800
Net	Roll 1(32x32)		24,500	
Net Fixing Cost			20,000	44,500
Nursery seed & other			5,000	5,000
Coir dust	25kg	140.00x40	5,600	
Compost	25kg	500.00x10	5,000	10,600
Polythene bags	kg	200.00x10	2,000	
Material for floor cover	Kg	200.00x7	1,400	3,400
Albert solution	Kg	350.00x25	8,750	
Calcium Nitrate	Kg	130.00x5	650	
Potassium Nitrate	Kg	210.00x4	840	
Other Fertilizer	Kg		1,250	11,490
Agro Chemicals			5,000	
Vitamins & Liquid Fertilizer			1,000	6,000
Threads & wires			3,500	3,500
Total				158,130

Source: Field Survey, 2012

There are about 6 varieties of bell pepper available in the country. The demand for each variety varies according to the need of the customer. The larger bright coloured good quality bell peppers are purchased by the exporters. These bell peppers are marketed at higher prices compared to other small sized less weighted ones. Bell peppers are harvested by hand every week and most of the crop is sold as mature green peppers. Some of the farmers are used to harvest red or yellow bell peppers, which are actually the mature stage of green bell peppers that have been allowed to ripe on the vine, because their prices are very high compared to that of green peppers. The cost of production of red or yellow bell peppers is higher than that of green bell peppers because losses at the field level are higher and yields are lower than those harvested at the green stage.

The following varieties are available in the Uva Paranagama and Bandarawela areas.

Red Peppers: King Arthur, Sakata, Indra

Yellow Peppers: Polaris, Orable, Twingo

Prices of Twingo and King Arthur seeds are very high compared to that of other varieties. But the yields of these varieties are also very high. Growers prefer these varieties because the seed quality is also very good. As the quality of final produce is very good their prices reach the maximum level at all times. About 1600kg of yellow bell pepper can be harvested from a 1000sq feet poly tunnel by cultivating Polaris seed. The variety called Indra also produces very attractive bright colour bell peppers with good quality and a higher yield (1500 – 1800kg per 1000sq feet poly tunnel). The seed cost for this variety is Rs.1600 per 100g. About 360 – 400 plants are maintained in a 1000sq feet poly tunnel. About 1.5kg -2kg of good quality bell pepper fruits can be harvested from one plant. Grade two fruits are also harvested and it is about 500grams per plant. The technical staff of the UPEPV provided technical know-how to the poor farmers in the area to get the maximum yield.

Table 2.7: Average Production of Bell Pepper from 1000sq Poly Tunnel

Period	1st Month	2nd Month	3rd Month	4th Month	5th Month	6th Month	7th Month	8th Month
Production (kg)	80	105	130	100	50	70	70	70

Source: Survey data 2012

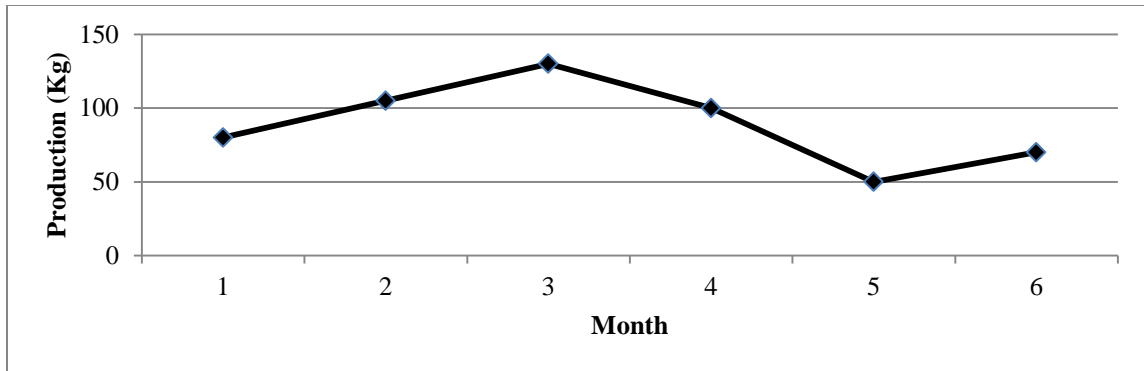

Source: Survey data 2012

Figure 2.2: Bell Pepper Production under 1000sq Poly Tunnel

Bell peppers contain no capsaicin and it gives chilli pepper pungency. They are high in Vitamin C and one medium green bell pepper contains 177 per cent of the Recommended Dietary Allowance (RDA) for vitamin C. When they become matured and turn colour, the Vitamin A content rises by a factor of nine while the Vitamin C content doubles. The brighter coloured peppers tend to be sweeter than green peppers because the sugar content increases as the pepper matures. Peppers are also excellent sources of dietary fibre and provide small amounts of several other vitamins and minerals.

Red peppers have more vitamins and nutrients and contain the antioxidant lycopene compared to that of green peppers. The level of carotene is nine times higher in red peppers. It was revealed that one large red bell pepper contains 209 mg of vitamin C and it has twice the vitamin C content of green peppers.

In the last few years bell pepper production and consumption have increased in Sri Lanka because bell peppers are used in salads and many other food preparations due to its mild and sweet taste. As the tourist industry has expanded the demand from the tourist hotels has also increased. The available data reveals that Uva Paranagama area leads in bell pepper production compared to Nuwara Eliya. The collection of bell peppers has increased in UPEPV from 6,494 kg in 2009 to 11,741kg in 2012 (up to end of July). The crop was valued at Rs.1,421,204 in 2009 and Rs.2,136,981 in 2012. Compared to 2009 the total bell pepper purchases had increased by 112 per cent in 2010 and the amount paid for farmers had increased by 142 per cent. In 2011 the trading activities had failed and farmers moved away from the company. As a result the purchases had declined by 16 per cent in 2011 compared to that of 2010. However, youth entered the business and they are engaged in this crop sector as entrepreneurs. They provide technical knowhow as well as services for building poly tunnels and repairs, supplying agro chemicals, seeds etc. to farmers. Hence the small scale farmers are linked to this centre by acquiring the trust. Therefore these youth have the confidence to expand the business. By purchasing bell pepper only they paid Rs.2 million during the first half of the last year.

Table 2.8: Nutritional Value per 100g of Bell Pepper Sweet, Green, Raw

Principal Nutrients	Nutrient Value
Energy	84 kJ (20 kcal)
Carbohydrates	4.64 g
- Sugars	2.4 g
- Dietary fiber	1.7 g
Fat	0.17 g
Protein	0.86 g
Vitamin A equiv.	18 µg (2%)
- beta-carotene	208 µg (2%)
- lutein and zeaxanthin	341 µg
Thiamine (vit. B1)	0.057 mg (5%)
Riboflavin (vit. B2)	0.028 mg (2%)
Niacin (vit. B3)	0.48 mg (3%)
Pantothenic acid (B5)	0.099 mg (2%)
Vitamin B6	0.224 mg (17%)
Folate (vit. B9)	10 µg (3%)
Vitamin C	80.4 mg (97%)
Vitamin E	0.37 mg (2%)
Vitamin K	7.4 µg (7%)
Calcium	10 mg (1%)
Iron	0.34 mg (3%)
Magnesium	10 mg (3%)
Manganese	0.122 mg (6%)
Phosphorus	20 mg (3%)
Potassium	175 mg (4%)
Sodium	3 mg (0%)
Zinc	0.13 mg (1%)
Fluoride	2 µg

Source: USDA Nutrient Database

Percentages are relative to US recommendations for adults.

Table 2.9: Bell Pepper Purchases at the UPEPV and Value of the Purchases

Year	Crop	Quantity (kg)	Average Producer Price (Rs/kg)	Value (Rs.)	% Change compared to 2009 (Quantity)	% Change compared to 2009 (Value)
2009	Green Pepper	2,595	169	432,463		
	Red Pepper	2,503	246	603,607		
	Yellow Pepper	1,396	281	385,134		
	Total	6,494		1,421,204		
2010	Green Pepper	7,666	202	1,630,608		
	Red Pepper	2,300	381	804,498		
	Yellow Pepper	3,818	286	1,009,891		
	Total	13,783		3,444,996	112.2	142.4
2011	Green Pepper	6,258	231	1,457,831		
	Red Pepper	2,375	235	498,348		
	Yellow Pepper	2,971	366	1,080,644		
	Total	11,604		3,036,823	78.7	113.7
2012 up to end of July	Green Pepper	3,980	141	539,843		
	Red Pepper	4,671	210	873,670		
	Yellow Pepper	3,090	257	723,468		
	Total	11,741	203	2,136,981	80.8	50.4

Source: Uva Paranagama Export Production Village

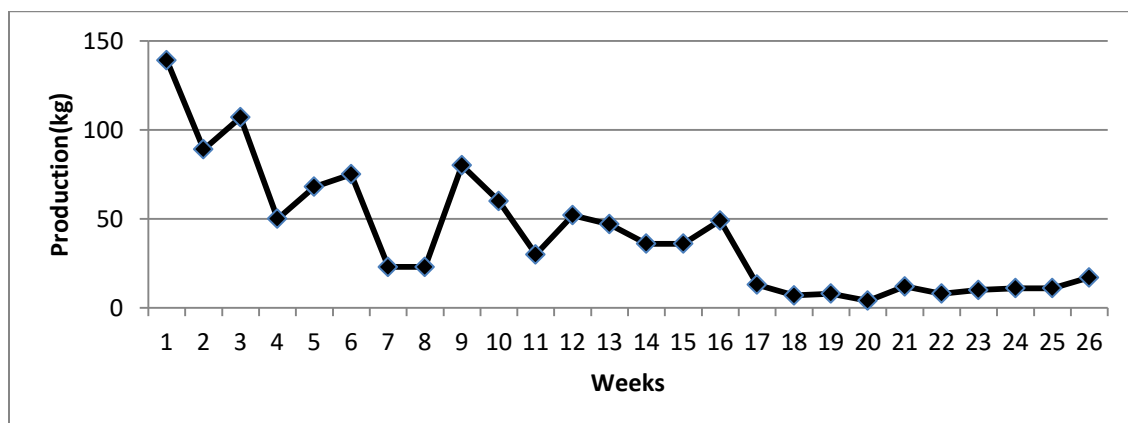

Source: UvaParanagama Survey 2012

Figure 2.3: Weekly Average Tomato Production under 1000sq feet Poly Tunnel

Farmers use poly tunnels for tomato cultivation and they are reluctant to grow tomato due to low returns during the peak harvesting season in the open field.

2.4 Behaviour of Farmers

The demand from local consumers as well as exporters has changed gradually during the last decade. This change has given more opportunities to local vegetable farmers to produce various types of vegetables and thereby increasing their farm income. The demand as well as the quality of vegetables varies according to the market places. To supply vegetables to exporters, tourist hotels, supermarkets, restaurants and other food retail stalls farmers plan the cultivation. Their farming practices differ according to the experience and the level of taking the risk of marketing these produce. Well experienced farmers do multicropping and relay cropping while others do monocropping. They are practicing multicropping in a very small scale and at present they obtain a higher income. The cultivation practices in the up country highlands have improved with the introduction of new technology. In the past, in cool highlands monocropping, multicropping and relay cropping were practiced in vegetable production and these farmers were competent and their vegetable production and marketing were well organized (Ranaweera *etal.*2000). This experience was helpful to farmers in Nuwara Eliya and Bandarawela areas to capture this vegetable sector too.

Farmers in the Uva Paranagama area cultivate many crops in the same land to maximize their farm income. As there is no database available on extent cultivated by each farmer to prove this situation, their sales through UPEPV purchasing centre were used to understand the cropping pattern in the area. Some of the farmers do not cultivate traditional vegetables and they have moved to this crop sector due to high returns. There are about 120 farmers linked to this purchasing centre and another 100 farmers are linked to other collectors in the area. Considering the cultivation of these crops, one crop is cultivated by many farmers. The following table depicts that about 120 farmers are engaged in cultivation of these crops. The crop rotation is practiced by all farmers.

The number of Farmers engaged in Cultivation of bell pepper and tomato under poly tunnels has increased gradually. Farmers who cultivate Chinese cabbage, iceberg, lettuce and Pak Choy have also increased gradually and they have links to the private sector collectors. It was observed that many farmers grow about five crops in the same land.

Table 2.10: Cultivation under Poly Tunnels by Farmers in Uva Paranagama Area

Crops	No. of Farmers		
	2010	2011	2012
Bell pepper green	7	21	8
Bell pepper green & red	15	13	16
Bell pepper green, red & yellow	27	20	13
Bell pepper green & yellow	11	22	4
Bell pepper red	3	5	8
Bell pepper red & yellow		2	7
Bell pepper yellow	2	5	5
Green, red bell pepper & Tomato			1
Green, red, yellow bell pepper & Tomato			1
green, yellow bell pepper & Tomato			1
Tomato			17
Total	65	88	81

Source: Uva Paranagama Export Production Village 2012

This table shows that the number of farmers engaged in cultivation of bell pepper have increased. Though the farmers linked to the UPEPV purchasing centre has shown a slight decline, number of farmers entering this crop sector has increased gradually. Well experienced farmers entered the trading activities too. Another vital feature is that due to various reasons farmers select crops for growing. The main reasons envisaged were their experience, farm income, convenience in growing and short growing period. After building the poly tunnel, most of the farmers grow bell pepper. After getting the income from that poly tunnel each farmer built another one or two and tomato cultivation was started under poly tunnels. During the harvesting period of open field tomato cultivation, prices of tomato dropped badly. Hence farmers limit tomato cultivation under poly tunnels.

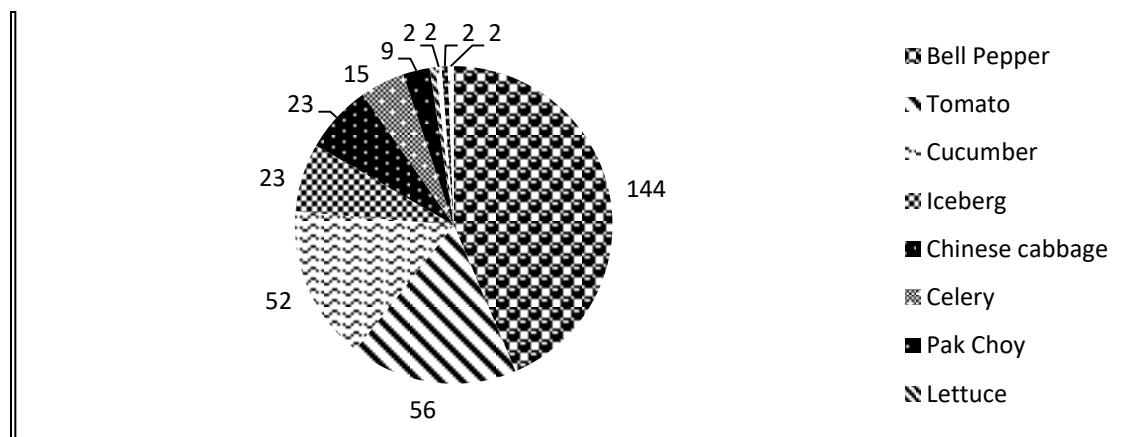

Source: Uva Paranagama Export Production Village Company

Figure 2.4: Number of Farmers Engaged in High Value Crop Production in Uva Paranagama Area -2010

Considering the cultivation pattern of farmers it was reported that the farmers who are engaged in bell pepper cultivation grow other high value crops such as tomato, iceberg and cucumber. These farmers have two to three poly tunnels and they grow these crops in the poly tunnels. The records proved that about 47 farmers cultivate bell pepper and these crops in 2011. Farmers cultivate iceberg in the open field to minimize the cost. The crop production data showed that many farmers cultivate bell pepper and other high value crops to maximize their farm income. But the farmers engaging in the supply chain through UPEPV Company have found new chains. Hence the farmers who cultivate bell pepper, tomato and cucumber are still engaged in this supply chain. Out of 270 farmers 62 per cent cultivate bell pepper, 12 per cent grow green cucumber, 11 per cent cultivate tomato and 14 per cent grow iceberg, celery, Chinese cabbage and Pak Choy. During January to July 2012, 80 bell pepper farmers are linked in bell pepper supply chain and these 80 farmers comprised 58 green pepper farmers, 56 red pepper farmers and 39 yellow pepper farmers. The growing of bell pepper variety is based on the prices received during the previous season. Well experienced farmers cultivate both red and yellow bell pepper varieties and this is about 13 farmers. Altogether 116 farmers were identified and they cultivate other high value vegetables also. According to the views of farmers and traders in the area the total number of farmers is about 400. But the collectors were reluctant to divulge all the details.

2.5 Overview of the Marketing of High Value Vegetables

The leading purchasing centre in the Uva Paranagama area was the Uva Paranagama Export Production Village (UPEPV) purchasing centre. The high value crop farmers in the area had to sell their production to this centre and about 100 farmers are linked in 2010 and the number has increased to 125 in 2011. As the growers found new ways to sell their produce, the number of farmers linked to the centre has declined to 116 in 2012. Considering the years of 2010, 2011 and 2012 cultivation of high value crops, about 190 farmers are directly linked to the UPEPV purchasing centre and also to other collectors in the village for selling their produce. The total annual sales by each farmer to the UPEPV purchasing centre, varied from 10kg to 5000kg. The following table shows that only 2 farmers sold more than 4000kg and 157 farmers sold less than 1000kg during the period of 2010 to 2012. In 2012, the UPEPV Company purchased bell pepper, cucumber, tomato, Zucchini and a very limited quantity of other leafy vegetables from about 120 farmers. The sales quantities showed that the highest number of farmers grow bell pepper (64) followed by cucumber and tomato (17 each), and also cucumber and bell pepper are cultivated by 13 farmers.

Table 2.11: Number of Farmers Inked to UPEPV and their Sales

Sales	4Mt <	3<>4Mt	2<>3 Mt	1<>2 Mt	1 Mt >	Total
No. of farmers	2	4	5	23	157	191

Source: Uva Paranagama Export Production Village

Almost all the farmers grow about 3- 4 crops in the same land to maximize their income. The cropping pattern varies on the market demand and the relative prices.

Some of the growers cultivate many crops such as celery, Chinese cabbage, cucumber, iceberg, tomato and pepper. Most of the farmers who grow Chinese cabbage and iceberg are engaged in greenhouse cultivations also. Under the poly tunnels they cultivate tomato or bell pepper. As the Chinese cabbage cannot be planted in the consecutive periods these farmers cultivate zucchini or green cucumber. The cropping patterns and cultivation practices can be explained as follows.

There were 144 bell pepper growers in 2010 and out of these growers 31 are engaged in tomato cultivation and 38 grow cucumber too. Some of these bell pepper farmers cultivate Chinese cabbage or iceberg in the open field. About 5 farmers cultivate bell pepper, Chinese cabbage, cucumber, tomato, iceberg and Pak Choy in the same land. Some of the farmers engaging in open field cultivation grow Chinese cabbage with celery or iceberg and Pak Choy. About 35 farmers grow only cucumber and 6 farmers grow iceberg, celery, lettuce, Pak Choy, mint and basil. About 20 farmers grow only tomato under poly tunnels. The farmers started cultivation with one poly tunnel by only growing bell pepper or tomato, built another poly tunnel later and grow more at present. Majority of the bell pepper farmers sell small quantities to this purchasing centre by anticipating future sales when the supply is very high. According to the available information about 400 poly tunnels (50'x20') have been built in the area.

In 2010, 17 Iceberg farmers were linked to the UPEPV purchasing centre and 7 farmers found new ways to expand their sales in 2011. The UPEPV limited the purchase of lettuce varieties and other herbs to avoid losses due to lack of trust with one of the exporters. Hence the total number of farmers dealing with this centre has declined sharply to 121.

Table 2.12: Cropping Pattern of High Value Vegetables and the Number of Farmers in the Supply Chain

Crop	Number of Farmers		
	2010	2011	2012
Bell pepper	41		64
Bell pepper & tomato	6	10	
Tomato	12	9	17
Bell pepper, tomato & cucumber		4	4
Bell pepper & Chinese cabbage	7		
Bell pepper, Chinese cabbage & cucumber	2		
Bell pepper & cucumber	5	19	13
Bell pepper & Ice berg	3	5	
Lettuce & tomato	2		
Ice berg	3		
Chinese cabbage & iceberg	3	8	
Basil & celery	4		
Chinese cabbage, iceberg, lettuce & mint,	4		
Chinese cabbage & iceberg, lettuce, mint, Red cabbage	2		
Cucumber	6	9	17
red cabbage	1		64
Chinese cabbage	1		
Celery		2	17
Celery & tomato		2	4
Celery & Zucchini		1	
Pak Choy		3	
Total No. of Farmers	102	75	116

Source: Uva Paranagama Export Production Village

The total quantity of high value vegetable purchases of the Uva Paranagama Export Production Village purchasing centre in 2011 has shown a sharp decline because the business had stopped for about two months and large scale farmers had started agribusiness.

Table 2.13: Number of Farmers in the Supply Chain through UPEPV

Crop	2010	2011	2012
Bell pepper Green	60	76	58
Bell pepper Red	48	42	56
Bell pepper Yellow	42	49	38
Chinese cabbage	18	9	
Cucumber	15	32	34
Iceberg	17	10	
Lettuce	3		
Pak Choy	8	7	
Tomato	23	30	25
Red Cabbage	6	2	
Zucchini		1	1
Mint	6		
Basil	4		1
Red Turnip		1	
Celery	11	11	
Total	261	270	214

Source: Uva Paranagama Export Production Village

Considering the farmers' relationship with the UPEPV purchasing centre, 49 farmers sold less than 100kg and another 44 farmers sold 100kg - 500kg of high value vegetables to the UPEPV in 2011. Nearly 500-1000kg of high value vegetables were sold by 20 farmers and over 1000kg were sold by only 6 farmers. Some of the farmers sold their total produce to the UPEPV while some of the farmers sold to the high value vegetable collectors in the area. To overcome the marketing problems almost all the farmers searched new collectors in the area to sell their produces. During the year, 16 farmers earned more than Rs.100,000 by selling HVV to this centre. The following table depicts that most of the farmers are small scale farmers.

Table 2.14: Sales Quantities and Earnings of Farmers in 2011

Earnings	Farmer earnings from HVV crops in 2011 (Rs)						
	10,000>	10,000< ≤25,000	25,000< ≤50,000	50,000< ≤100,000	100,000< ≤150,000	150,000< ≤200,000	200000<
No. of farmers	30	19	35	19	12	3	1
	Quantities sold (kg)						
Quantity sold	50>	50 < ≤100	100< ≤250	250< ≤500	500< ≤1000	1000<	
No. of farmers	30	19	20	24	20	6	

Source: Uva Paranagama Export Production Village

The farmers of this vegetable sector were linked to the collectors in their own areas. Hence most of the farmers sold very small quantities to the UPEPV purchasing Centre.

Table 2.15: No. of Bell Pepper Farmers and their Sales through UPEPV – 2011

No. of Farmers	Farmers' Sales as a % of Total								Total
	1>	1	2	3	4	5	5<10	10<	
Red Pepper	11	4	6	3	4	4	2	1	35
Yellow Pepper	17	13	9	2			5	1	47
Green Pepper	34	14	9	6	2	2	2	1	70

Source: Uva Paranagama Export Production Village

In 2012 this centre purchased mainly bell pepper, tomato and cucumber and 80, 26 and 33 farmers had grown and sold these crops respectively. Other collectors did their service to the other high value vegetable farmers. The leafy vegetables are sold through vegetable collectors in the area. In this area many farmers cultivate Iceberg, Pak Choy and basil. Very few farmers cultivate Chinese cabbage. All these crops are grown in Nuwara Eliya area as well.

According to the main collectors in Nuwara Eliya, they purchased about 40kg of broccoli and 45kg of cauliflower daily in 2011 and that of cauliflower has declined sharply in year 2012 because many more traders purchased cauliflower and distributed among various local traders and hoteliers. Apart from that, they purchased other crops such as Chinese cabbage, iceberg, celery, zucchini, lettuce, tomato and Pak Choy. Hence purchases of these quantities have also declined by about 3-5kg daily. As a result, many traders were reluctant to provide data for this analysis.

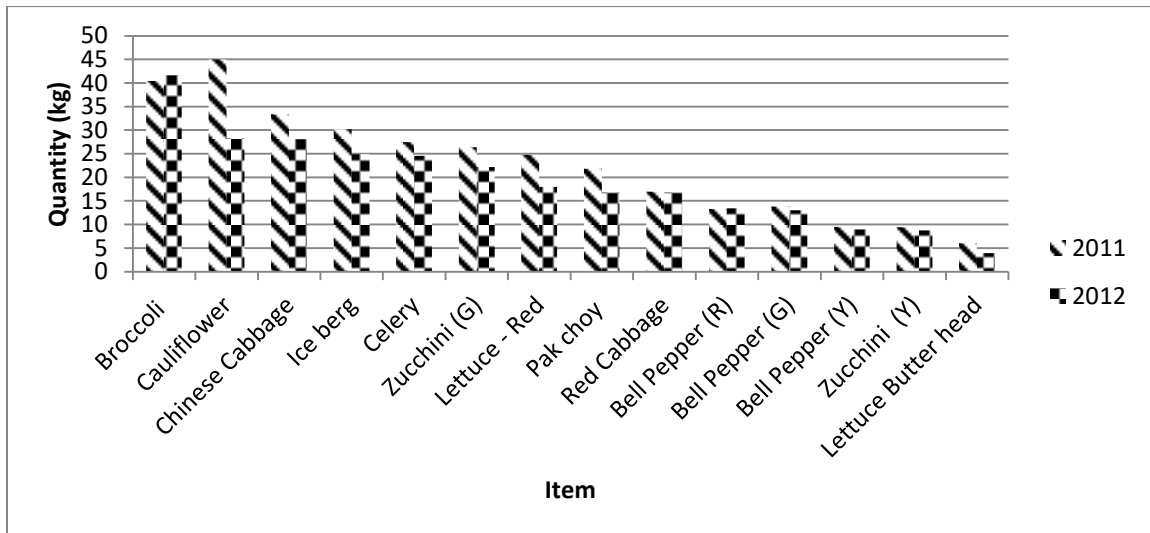

Source: Uva Paranagama Export Production Village

Figure 2.5: Average Daily Demand from Main Collectors in Nuwara Eliya

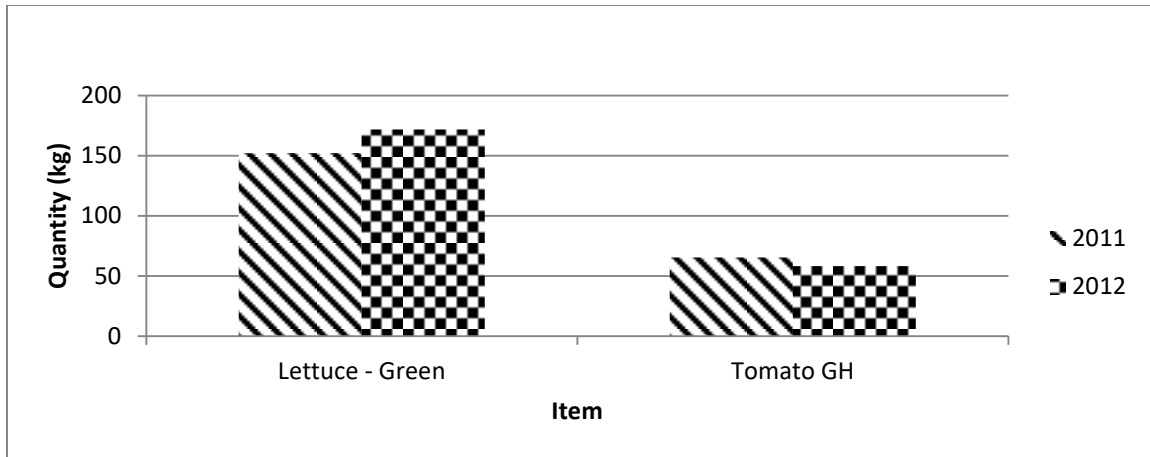

Source: Uva Paranagama Export Production Village

Figure 2.6: Average Daily Demand from Main Collectors in Nuwara Eliya –Lettuce & Tomato 2011-2012

The market is highly competitive considering the bell pepper production and marketing because there is a specific demand created from limited suppliers and customers. The quantities of supplies varied widely among the collectors. A large number of small scale growers have begun cultivating bell peppers and very few traders influence the market by purchasing a considerable share of domestic production and a very limited number of collectors distribute among major regional food marketing chains and processors. Small scale growers are linked with the large scale growers who collect bell peppers and other high value produce. These collectors help the small scale farmers by providing required seeds and agro chemicals if necessary. These farmers are not in a position to fix the price for their produce as the market prices are determined by the collectors. The current producer prices of green, red and yellow bell peppers are Rs.140, Rs.160 and Rs.275 per kg.

There are few marketing channels observed for bell pepper. The importance of these marketing channels is that the chain is very short to minimize the wastages. However the growers have to sell their produce to the village collector or directly to the collector in the nearest town. The collectors sell the produce in accordance with the orders placed by the regional managers of supermarkets and the cooperative or the collecting centre initiated by the Export Development Board. Exporters are directly linked with the cooperative or export production village outlet to purchase the required quantity on a regular and pre-arranged basis. These traders maintain reliability with the exporters and other wholesalers as well as the growers.

2.6 Price Behaviour of High Value Vegetables

In general, prices are predetermined (Annex 5) and the collectors receive orders from the exporters, cooperatives, tourist hotels, supermarkets and UPEPV managers.

According to the order, collector asks growers to harvest the crops. To collect the produce without damages, collectors visit farmers and use their own vehicles to transport these high value crops to the cooperative or UPEPV purchasing centre. Some of the small scale women growers are reluctant to visit the town and they sell their crops directly to the village collector or at Bandarawela and Nuwara Eliya by public transport. The small scale growers do not sell their produce directly to the tourist hotels because at present collectors sell these products to the hotels. If a grower does not use a collector and sell directly to the hotels or wholesalers the product is subject to higher price fluctuations. And sometimes village collector refuses to buy that growers' produce. The marketing cooperative and UPEPV generally use a pooled daily cost that spreads overall purchases. High value perishable crops have the potential to expand incomes along the whole supply chain from the farmer to consumer, because these chain actors enjoy higher prices and better profit margins.

Bell peppers are usually marketed as fresh produce. Hence the growers use new techniques to obtain the year round produce. As all the production comes from controlled environment bell peppers are available throughout the year. But the peak and lean production can be observed during the year. Accordingly the prices fluctuate. The following charts depict this situation. During February and March 2012 peak supply hit the market by causing a decline in the prices by 80 per cent compared to that in 2011. In April to August and December to January export orders are very low compared to other months.

In May 2012 producer prices of green bell pepper have increased by 60-100 per cent compared to May 2011. But the price increase in June and July was around 25 per cent compared to 2011.

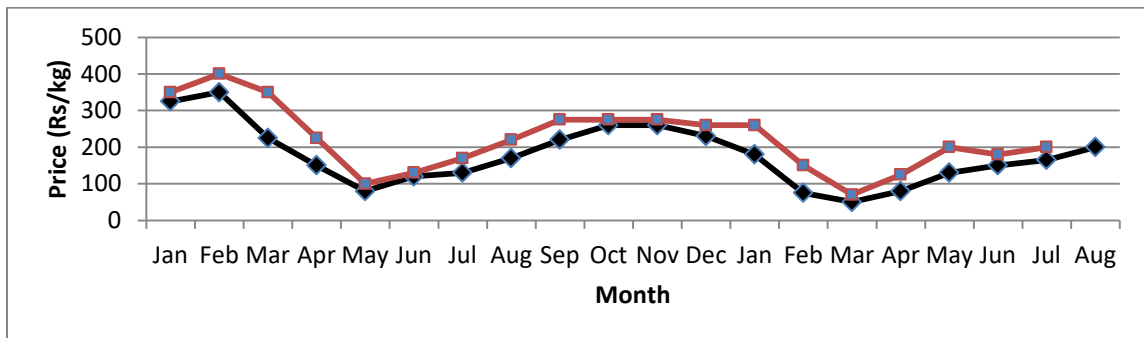

Source: Ag Co Nuwara Eliya

Figure 2.7: Producer Price Ranges of Bell Pepper – Green 2011-12

Producer price ranges of red bell pepper have declined in 2012 compared to that of 2011 during the first half of the year in the range of 29 to 90 per cent because many farmers cultivated bell pepper to receive a higher income. In May 2012 producer prices

have increased by 75 per cent compared to 2011. Since then the prices have shown an increase.

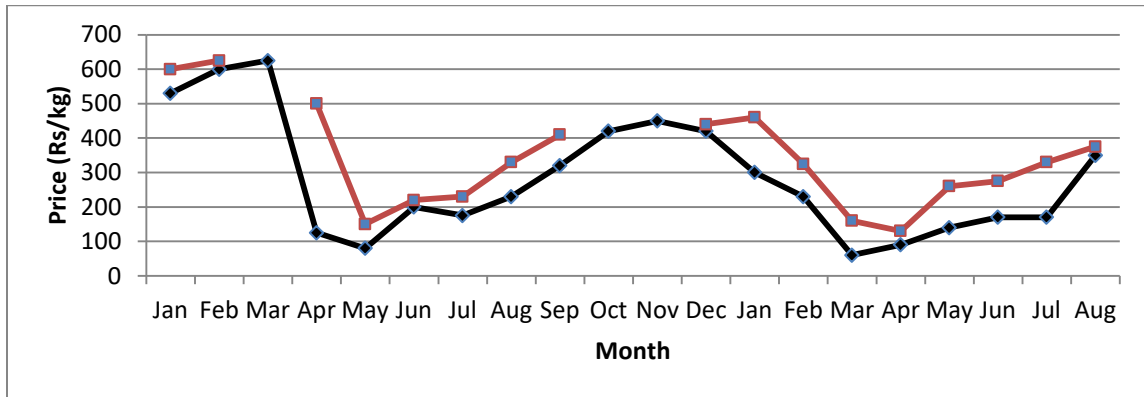

Source: Ag Co Nuwara Eliya

Figure 2.8: Producer Price Ranges of Bell Pepper – Red 2011-12

Bell pepper yellow has also shown the same price trend as mentioned earlier. In May, producer prices have increased sharply by 188 and 120 per cent for lower and higher prices.

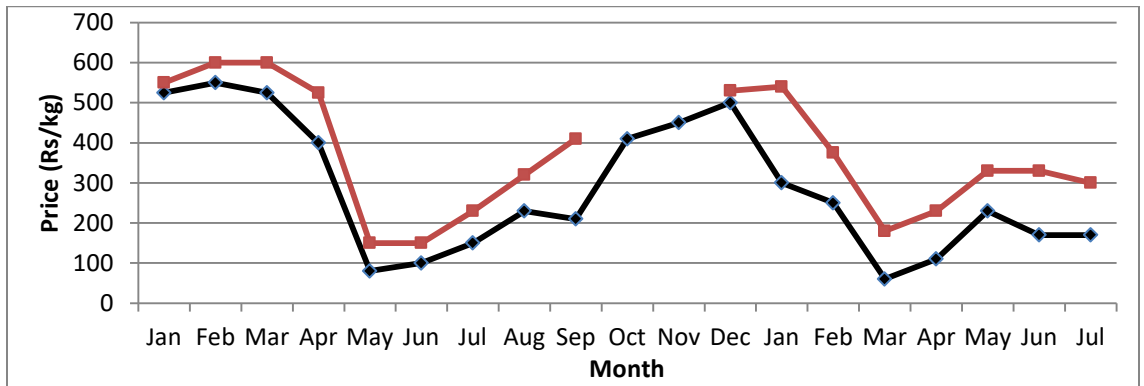

Source: Ag Co Nuwara Eliya

Figure 2.9: Producer Price Ranges of Bell Pepper – Yellow 2011-12

Producer prices of greenhouse tomato in 2012 were lower than the prices prevailed in January to April 2011 by about 50 to 69 per cent. Since May, producer prices have increased by about 40 to 100 per cent.

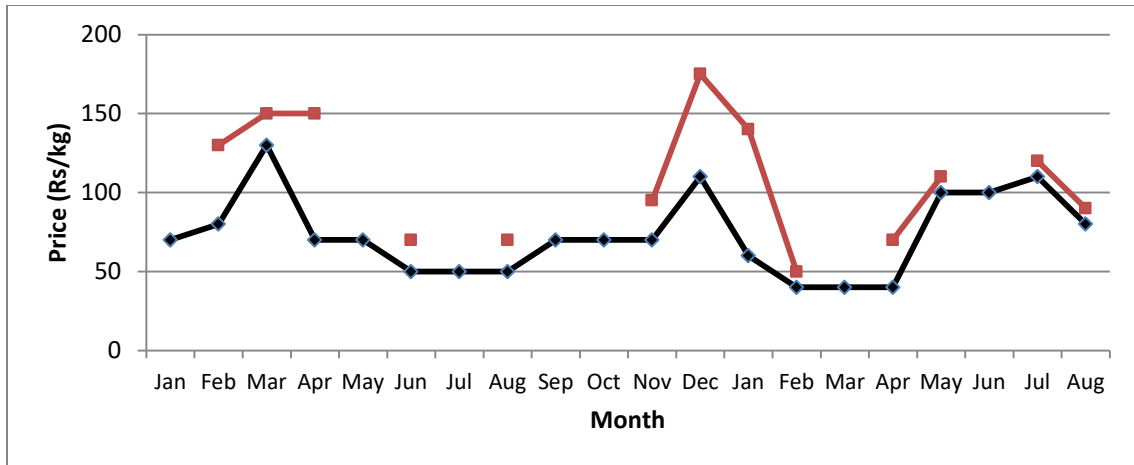

Source: Ag Co Nuwara Eliya

Figure 2.10: Producer Price Ranges of Tomato 2011-12

Except for March and April in 2012 the producer prices of green cucumber have declined by 17 to 40 per cent compared to that of 2011. As the producers received about Rs.100.00 to Rs.130.00 per kg in the latter part of the year 2011, more farmers cultivated cucumber. As a result the prices have declined in 2012 and prices have ranged between Rs.50 to Rs.80.00 per kg.

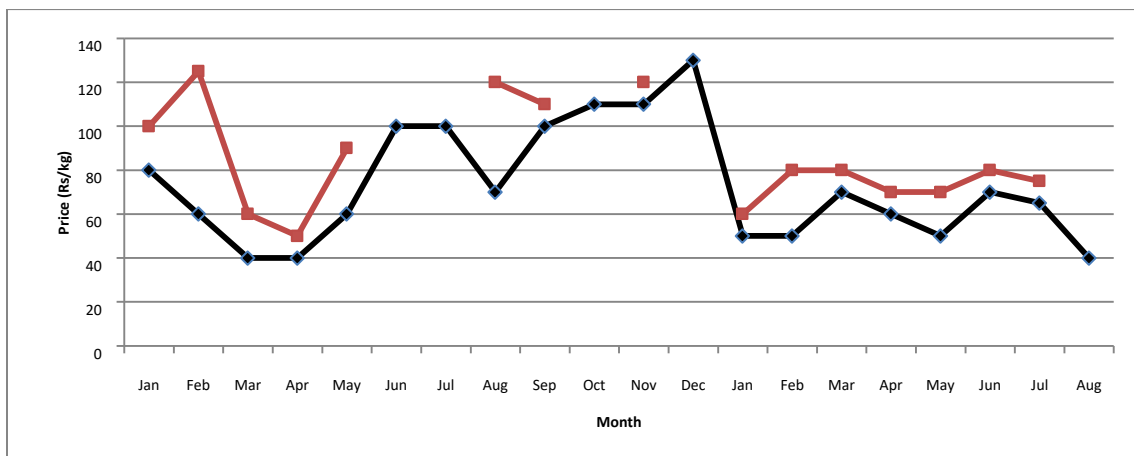

Source: Ag Co Nuwara Eliya

Figure 2.11: Producer Price Ranges of Cucumber - Green 2011-12

Uva Paranagama Export Production Village (UPEPV) purchasing centre purchased nearly 48mt of high value vegetables in 2010 and it has dropped to 40mt in 2011. During the first half of 2011 the UPEPV purchasing centre was unable to purchase these items from the farmers due to financial constraints. Farmers in the area used to sell their high value vegetables to the UPEPV and in 2009 and 2010 the company purchased about 15 high value vegetables and herbs. However up to July 2012 it has purchased 25mt of high

value vegetables such as bell pepper, tomato and green cucumber. Due to unavoidable circumstances this purchasing centre limit purchases to bell pepper, tomato and cucumber. Though this area is very famous for iceberg lettuce this company did not purchase this crop. The leading collectors in the area purchase those produces and distribute among supermarkets, tourist hotels, exporters and to the local wholesalers and retailers. The supply chains have developed very well.

Purchase of high value vegetables by the UPEPV in 2010 was very high and all types of high value vegetables were purchased by the company during that period (Annex 4). In 2011 the purchases were very limited because the company faced financial crisis in paying farmers in time. The rejections were about 2-3 per cent of the sales value at the earliest stage. Most of the farmers have about 10-year experience for cultivation and selling of some of these commodities. Farmers and collectors faced many problems with the higher rates of rejection by one of the leading exporters during the latter part of 2010. The average rejection rate was about 17 per cent of the sales value in 2010. Hence the collectors were not able to pay for the purchases. To overcome the problems they had to find new ways to sell their produces. As a result the domestic sales network has improved at a satisfactory level to enhance the farm income in the area. According to the farmers they are at a better economic level at present.

Table 2.16: UPEPV High Value Crop Purchases

Year	Quantity (kg)	Value (Rs.)
2010	48,020	6,881,002
2011	39,129	5,486,421
2012 up to July	25,178	2,956,278

Source: Uva paranagama Export Production Village

This crop sector was introduced to the farmers in Uva Paranagama area in 2008 and it was popularised among farmers very slowly in 2008 and 2009. About 55 farmers sold their production of high value vegetables to the UPEPV Company in 2009. From 2009 to 2010 the cultivation has spread among 102 farmers by indicating 85 per cent increase. From 2010 to 2011 about 32 farmers entered this crop sector and it was a 32 per cent improvement compared to 2010. According to the available information at present the number of farmers engaged in this crop sector a more or less stable in the Uva Paranagama and Bandarawela areas.

The value of total purchases in 2012 was about Rs.mn.0.4 and both overheads and profit margin was about 75 per cent of the total value of purchases. Three leading vegetable export companies purchased over 75 per cent out of the total purchases of UPEPV. One collector purchased about 5 per cent and he distributed these stocks among traders in Hambantota area and another 2 per cent was purchased by another collector and he distributed those produces to the traders in Hikkaduwa area. Ten per cent was

distributed among tourist hotels and vegetable exporters in Nuwara Eliya. Less than 4 per cent was directly supplied to the wholesalers in the Manning market.

Table 2.17: Purchased Quantities of High Value Vegetables by the UPEPV - 2010 & 2011

Year	Celery		Chinese Cabbage		Cucumber		Ice Berg		Pak Choy	
	2010	2011	2010	2011	2010	2011	2010	2011	2010	2011
Jan	27		213	0	48	149	174	21	42	12
Feb	82	73	238	70	589	297	151		39	
Mar	176	17	407	42	595	596	430		196	
Apr	40	20	318		234	447	250		192	
May	107	45	426		508	436	100		183	13
Jun	129		423			395	227		286	
Jul	115	34	392	12	546	401	209	22	135	15
Aug	77	31	289	149	674	1129	124	222	93	131
Sep	88		361	153	907	906	345	222	85	203
Oct	179		535	134	992	1161	282	104	33	51
Nov	178		497	109	752	1141	227	51	130	
Dec	19		38	2	163	526	227			

Source: Uva Paranagama Export Production Village

Table 2.18: Purchased Quantities of High Value Vegetables by the UPEPV-2010 & 2011

Year	Green Pepper		Yellow Pepper		Red Pepper		Tomato		Red Cabbage		Lettuce
	2010	2011	2010	2011	2010	2011	2010	2011	2010	2011	2010
Jan	682	199	144	168	451	127	51	985	26	30	14
Feb	573	140	352	216	469	91	51	676	66		
Mar	736	275	628	201	689	2	636	637	193		
Apr	636	24	664	125	568	47	1635	1886	128	11	
May	482	335	224	415	320	130	1245	2174	78		
Jun	491	308	307	122	318	110	182	2356			10
Jul	549	595	253	240	145	435	411	978			
Aug	789	616	325	376	357	176	698	907			11
Sep	641	684	278	251	452	195	1182	1173			10
Oct	811	967	239	249	376	245	1248	867	24		
Nov	916	1010	224	201	183	225	1278	1117	171	164	
Dec	363	1107	182	408	185	519	689	527			

Source: Uva Paranagama Export Production Village

The small farmers have been benefited in Uva Paranagama area and received Rs.mn.6.9 in 2010 and Rs.mn.5.5 in 2011. Up to July 2012, farmers in the area received about Rs.mn. 3 from selling only three items through UPEPV. The other farmers in the area sold their produce to village collectors and according to them, their income also increased considerably.

Table 2.19: Earnings from High Value Vegetable Farming in Bandarawela Area in 2011 & 2012

Farmer Earnings from High value vegetables							
Year	10,000>	10,000< ≤25,000	25,000< ≤50,000	50,000< ≤100,000	100,000< ≤150,000	150,000< ≤200,000	200000<
2011	30	19	35	19	12	3	1
2012 up to July	37	29	14	13	1	1	1
Quantities sold by Farmers (kg)							
Year	50>	50 < ≤100	100< ≤250	250< ≤500	500< ≤1000	1000<	
2011	30	19	20	24	20	6	
2012 up to July	21	24	24	16	10	1	

Source: Uva Paranagama Export Production Village

This table shows that about 70 farmers linked with this company sell less than 250kgs. The intention of these farmers to link with this company was to sell their produce in the peak season because they face problems of selling produces to collectors during that period. The farmers who are directly linked with the private sector collectors handle large quantities. Exporters had problems of selling some of these high value vegetables in 2011 since the Robert-Koch Institute issued a warning on 25th May 2011 in connection with the consumption of lettuce, cucumber and tomato, the demand for these items declined. In June 2011 the institute announced that fresh vegetables could be consumed without any problem. However when the demand declined from exporters the UPEPV company stopped buying high value vegetables such as iceberg, Pak Choy and Chinese cabbage.

The demand for these crops was very limited. Hence collectors always place orders according to the demand. The collectors in the producing areas are linked with the farmers as well as with exporters and local traders. The following tables depict that the daily demand from collectors has declined because many large scale farmers have entered the trade because of high profit margins prevailing in this crop sector.

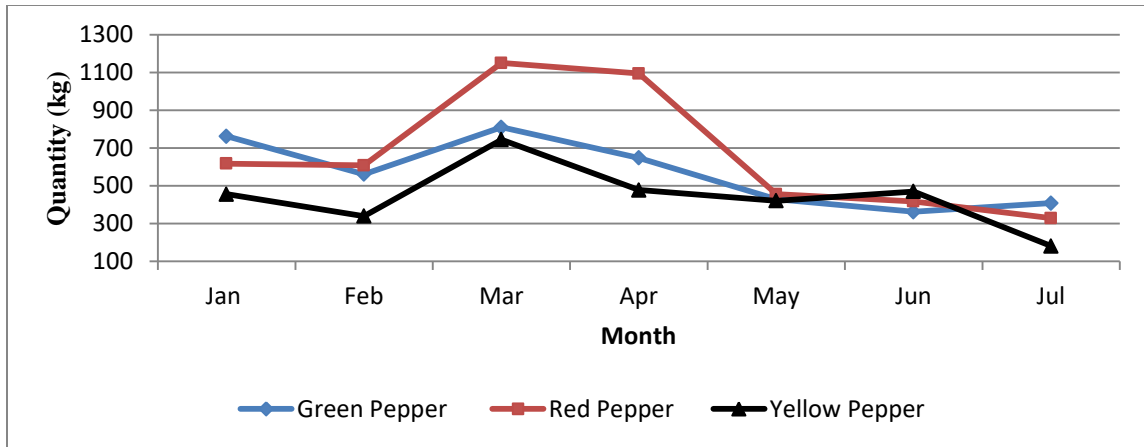

Source: Uva Paranagama Export Production Village

Figure 2.12: Monthly Purchases of Bell Pepper – UPEPV -2012

Up to April 2012 the monthly average producer prices of green bell pepper have declined by 26 to 80 per cent with the highest price decline of 78-80 per cent reported in March. During this period the higher production reached the market and purchases of the UPEPV also increased.

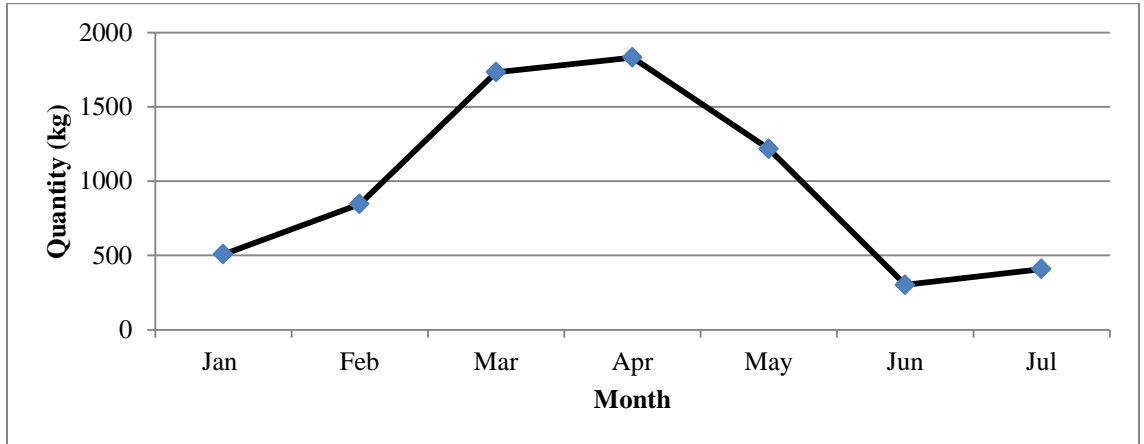

Source: Uva Paranagama Export Production Village

Figure 2.13: Monthly Purchases of Tomato – UPEPV -2012

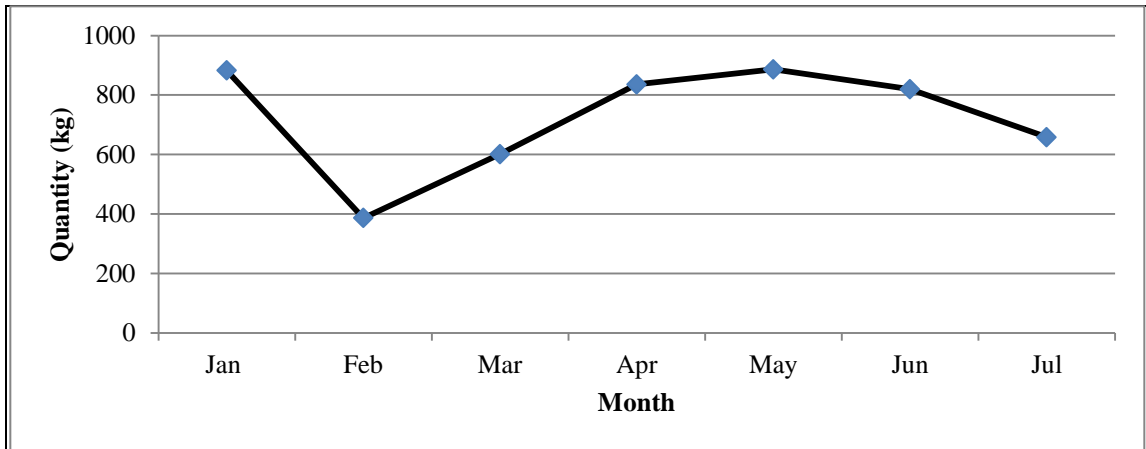

Source: Uva Paranagama Export Production Village

Figure 2.14: Monthly Purchases of Cucumber - Green – UPEPV -2012

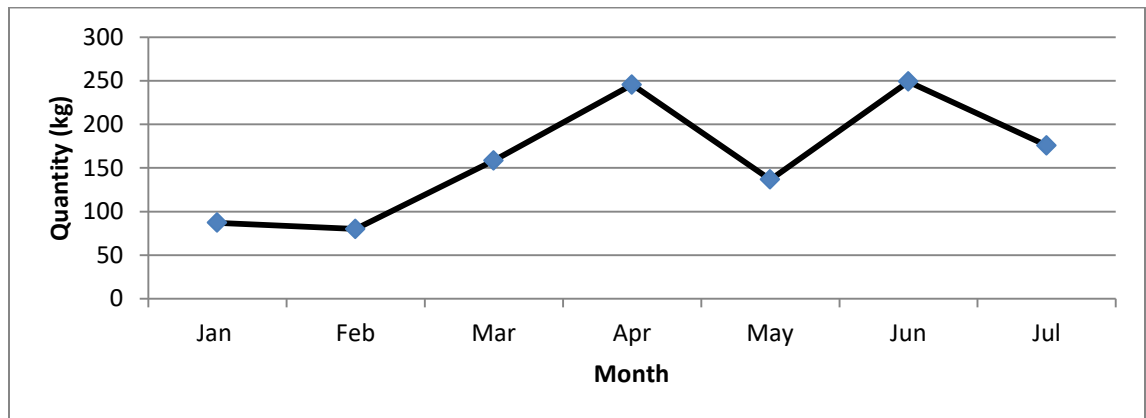

Source: Uva Paranagama Export Production Village

Figure 2.15: Monthly Purchases of Bell Pepper – Grade 2 – UPEPV -2012

January, April, May and June purchases of cucumber were above 800kgs. Monthly purchases of bell pepper were higher in January, March and April while peak purchases were shown in the latter months of 2012. Above 200 kg of grade 2 bell pepper was purchased in the months of April and June because the lean production season occurs in June. The highest purchases were recorded in March and April followed by May. In March and April monthly purchases were above 1600kg.

From January to April the producer prices of bell pepper have increased by over 100 percent while the prices have declined sharply since May through December 2011. Green cucumber prices have increased by over 50 percent in 2011 compared to that in 2010. The producer prices of Chinese cabbage have increased by over 20 per cent from July to September 2011 compared to the same period in 2010. As a result, the

cultivation had increased and the prices have declined through October to December in 2011. This trend could be seen for iceberg and other leafy vegetables too.

Table 2.20: Monthly Average Producer Prices of Bell Pepper in Bandarawela - 2010 & 2011 (Rs/kg)

Month	Bell Pepper (Rs/kg)								Price Changes % 2010-11			
	Green		Red		Yellow		Grade 2		Green	Red	Yellow	Gr.2
	2010	2011	2010	2011	2010	2011	2010	2011	2011	2011	2011	2011
Jan	157	332	276	554	282	544	70	50	112	101	47	-29
Feb	135	371	207	605	232	586	32	50	174	192	59	56
Mar	126	308	173	625	197	545	23	43	144	261	56	83
Apr	125	188	148	369	140	493	20	42	50	150	95	109
May	134	91	159	105	165	90	19	27	-32	-34	-71	40
Jun	143	123	226	207	207	132	40	45	-14	-8	-36	11
Jul	186	141	292	198	297	180	40	40	-24	-32	-59	0
Aug	252	186	336	283	329	282	40	50	-26	-16	-17	25
Sep	278	251	387	375	368	356	45	50	-9	-3	-3	11
Oct	313	264	411	420	406	410	50	70	-16	2	1	40
Nov	320	272	451	448	455	449	50	70	-15	-1	-1	40
Dec	314	249	509	427	506	514	50	70	-21	-16	2	40

Source: UPEPV & Survey data

Table 2.21: Monthly Average Producer Prices of Celery, Chinese Cabbage, Iceberg and Cucumber in Bandarawela - 2010 & 2011 (Rs/kg)

Month	Celery		Chinese cabbage		Ice berg		Cucumber		% Change 2010-11			
	2010	2011	2010	2011	2010	2011	2010	2011	Celery	Chinese cabbage	Ice berg	Cucumber
Jan	75		74		155	125	90	93				3
Feb	103	128	62	50	75		85	100	25	-19		17
Mar	108	233	59	80	74		86	41	115	36	-92	-52
Apr	120	50	56		81		85	47	-58			-45
May	154	90	95		258		90	76	-41			-15
Jun	217		111		300		110	100				-9
Jul	275	140	125	150	207	120	110	100	-49	20	-58	-9
Aug	226	113	117	148	141	130	85	104	-50	27	-7	22
Sep	97		108	130	62	130	67	106		20	53	58
Oct	55		117	83	78	95	70	109		-29	21	56
Nov	47		107	60	111	80	70	114		-44	-52	63
Dec	40		40	60	113		74	130		50		75

Source: UPEPV & Survey data

Table 2.22: Monthly Average Producer Prices of Greenhouse Tomato, Pak Choy, Red Cabbage and Lettuce in Bandarawela - 2010 & 2011 (Rs/kg)

Month	Crop								% Change 2010-11			
	Tomato		Pak Choy		Red cabbage		Lettuce		Tomato	Pak Choy	Red cabbage	Lettuce
	2010	2011	2010	2011	2010	2011	2010	2011				
Jan	70	70	65	65	95	200	40	n.a			162	
Feb	70	89	65		120				27			
Mar	69	133	58		160				93			
Apr	63	93	57		139	175			49			
May	65	70	97	50	122				8	-48	-244	
Jun	74	55	97				160		-26			
Jul	76	50	90	70					-34	-22		
Aug	75	59	76	70			125		-21	-8		
Sep	78	70	78	46			30		-11	-41		
Oct	86	70	45	37	225				-18	-19	-614	
Nov	78	91	64		214	70			17	-		
Dec	70	138							97			

Source: UPEPV & Survey data

The UPEPV limited its purchases to bell pepper, cucumber, zucchini and tomato in 2012. As the UPEPV curtailed buying leafy vegetables, all high value vegetable collectors in the sector are engaged fully in leafy vegetable business.

Table 2.23: Monthly Wholesale Price Ranges of Cucumber and Bell Pepper in Bandarawela – 2012

Month	Cucumber		Bell Pepper					
	Min.	Max.	Green		Red		Yellow	
			Min.	Max.	Min.	Max.	Min.	Max.
Jan	110	180	300	350	475	600	500	650
Feb	100	120	230	260	375	450	500	
Mar	90	120	110	175	175		175	180
Apr	100	110	130	200	190	240	200	350
May	110	120	200	300	240	400	350	400
Jun	120	130	275	300	375	400	375	400
Jul	110	120	250	300	275	425	275	325

Source: UPEPV & Survey data

Table 2.24: Average Daily Demand of High Value Vegetables from Leading Collectors per Month in 2011(kg)

Item	Jan	Feb	Mar	Apr	May	Jun	Jul	Aug	Sep	Oct	Nov	Dec
Bell Pepper (Green)	13	13	13	13	13	13	12	14	13	16	16	16
Bell Pepper (Red)	12	16	16	13	15	9	14	14	12	11	13	16
Bell Pepper (Yellow)	7	12	12	12	11	6	7	10	5	3	13	16
Lettuce - Green	164	157	167	146	150	128	126	119	146	154	204	166
Lettuce - Red	24	29	26	27	27	27	24	21	21	23	25	23
Lettuce-Butter head	5	7	6	11	5	9	5	3	7		3	
Broccoli	30	48	55	44	41	29	41	37	36	30	46	47
Cauliflower	50	55	70	75	60					15	16	18
Chinese Cabbage	33	35	36	30	35	34	32	28	32	33	35	37
Iceberg	28	38	29	31	28	31	28	27	29	27	35	32
Pak Choy	23	25	25	22	22	24	21	18	20	20	22	21
Red Cabbage	18	17	16	15	15	18	17	16	17	19	18	17
Tomato	77	80	72	65	63	70	57	41	43	57	97	62
Yellow Zucchini	11	11	11	8	9	11	9	9	10	8	6	8
Zucchini	25	28	29	22	29	28	24	23	24	24	37	25
Celery	26	32	28	28	29	28	25	24	26	27	29	28

Source: Agricultural Cooperative Society- Nuwara Eliya & Survey data

Table 2.25: Average Daily Demand of High Value Vegetables for each Month in 2012 (kg)

Item	Jan	Feb	Mar	Apr	May	Jun	Jul	Aug	Sep	Oct	Nov
Bell Pepper (Green)	11	15	13	15	16	13	13	13	11	11	11
Bell Pepper (Red)	11	15	14	16	17	17	15	12	7	10	11
Bell Pepper (Yellow)	8	12	9	7	12	11	7	7	5	8	9
Lettuce - Green	146	149	155	211	207	206	170	140	170	179	158
Lettuce - Red	17	18	16	21	15	19	17	16	17	21	21
Lettuce-Butterhead	6	5	5	2	3	3		4	4	4	
Broccoli	36	38	47	53	44	36	46	39	41	35	42
Cauliflower	27	22	17	17	71	66	27	16	14	15	18
Chinese Cabbage	32	28	28	33	31	29	26	17	25	28	32
Iceberg	23	22	23	34	24	28	25	15	25	26	29
Pak Choy	17	16	14	21	21	18	17	12	16	17	16
Red Cabbage	22	19	14	15	14	18	18	12	18	18	17
Tomato	51	54	53	70	76	62	55	65	53	52	52
Yellow Zucchini	9	7	8	10	9	9	8	6	9	10	11
Zucchini	24	22	20	26	24	22	20	18	21	23	23
Celery	25	24	23	29	27	27	25	17	23	24	26

Source: Agricultural Cooperative Society- Nuwara Eliya and Survey data

Experienced farmers entered marketing of these crops. Hence the daily demand from each collector was around 25kg. The highest daily demand was shown for salad lettuce because it has a higher domestic demand. There are about 6 wholesalers in the Nuwara Eliya Dedicated Economic Centre and among them only three lead the market. Some of the high value vegetable collectors distribute those vegetables to Colombo tourist hotels and they are very concerned about the product quality and appearance. Though almost all these crops are available throughout the year, there is seasonality. In February, March and April and also in July and August the supply increases. The demand increases in April and December.

The wholesale prices at Nuwara Eliya had increased in 2011 and those prices had declined in 2012 with increased supply. As the series of prices were not available in the Economic centre, prices were collected from the Agricultural Cooperative located in Nuwara Eliya. These prices are a little higher compared to that of other collectors in the area because the quality of the products needs to be very high to fulfil the demand from supermarkets and importing countries.

This review showed that this crop sector has gradually improved and there is a possibility to improve this sector as young people entering this agribusiness. Earlier the distribution system of vegetables from producer to consumer reported very high post-harvest losses due to lack of proper transport. After introducing tax and other incentives for the agricultural sector, mainly for duty free imports of capital goods, the distribution system improved rapidly by reducing wastages. The present system of distribution from the producer to the consumer of vegetables has helped the consumers to purchase good quality produce from green vegetable stalls as well as from supermarkets. Consumers have become increasingly conscious of good quality at the retail end of the supply chain. Therefore transporters of these products use their experiences to improve the product quality and minimize the losses during transportation.

Table 2.26: Monthly Average Wholesale Prices of High Value Vegetables in Nuwara Eliya in 2011 (Rs/kg)

Item	Wholesale Price (Rs/kg)											
	Jan	Feb	Mar	Apr	May	Jun	Jul	Aug	Sep	Oct	Nov	Dec
Bell Pepper (Green)	424	303	226	223	218	219	270	270	274	363	390	384
Bell Pepper (Red)	778	527	307	326	350	357	445	460	460	567	628	652
Bell Pepper (Yellow)	774	527	307	301	310	319	413	425	425	553	629	667
Lettuce - Green	117	118	90	90	92	170	181	201	129	236	260	224
Lettuce - Red	233	164	150	157	230	233	260	274	290	337	341	257
Lettuce-Butter head	400	400	400	400	400	400	400	400	400	400	400	400
Broccoli	560	500	303	259	175	227	316	340	290	414	423	550
Cauliflower	600	471	338	370	360	370	370	370	370	426	432	455
Chinese Cabbage	220	197	165	179	194	205	293	320	272	183	150	150
Iceberg	526	393	300	326	374	254	193	220	209	327	438	429
Pak Choy	125	124	125	158	170	168	150	150	134	140	173	190
Red Cabbage	508	339	288	243	195	178	200	220	194	195	247	529
Tomato	255	188	150	116	75	75	83	108	130	172	208	275
Yellow Zucchini	279	171	150	176	180	209	260	260	260	266	272	278
Zucchini	210	140	125	211	260	214	175	171	144	180	178	209
Celery	385	348	279	234	195	199	178	175	163	180	213	225

Source: Agricultural Cooperative Society- Nuwara Eliya & Survey data

Table 2.27: Monthly Average Wholesale Prices of High Value Vegetables in Nuwara Eliya in 2012 (Rs/kg)

Item	Wholesale Price (Rs/kg)										
	Jan	Feb	Mar	Apr	May	Jun	Jul	Aug	Sep	Oct	Nov
Bell Pepper (Green)	306	279	232	237	279	304	325	320	300	300	269
Bell Pepper (Red)	441	375	290	340	395	418	430	434	450	450	386
Bell Pepper (Yellow)	446	373	290	336	395	425	460	458	450	450	386
Lettuce - Green	132	113	89	100	164	170	164	159	124	135	138
Lettuce - Red	134	100	100	123	226	270	250	220	214	180	180
Lettuce-Butter head	400	400	400	400	400	400	400	400	400	400	400
Broccoli	380	400	336	373	364	491	464	294	269	397	375
Cauliflower	386	350	350	355	433	534	425	277	264	275	274
Chinese Cabbage	128	106	126	171	280	325	311	281	258	245	235
Iceberg	245	144	133	148	352	550	531	326	312	280	297
Pak Choy	137	116	107	160	187	210	190	136	135	137	160
Red Cabbage	529	377	271	225	255	290	278	222	252	260	257
Tomato	165	87	65	92	163	165	168	195	191	168	155
Yellow Zucchini	164	126	136	163	170	170	170	196	234	219	230
Zucchini	127	100	119	219	240	219	199	208	227	235	253
Celery	225	225	225	225	226	240	240	264	275	275	271
Green cucumber	-	-	146	170	166	162	162	145	120	113	275

Source: Agricultural Cooperative Society- Nuwara Eliya & Survey data

As the opportunities exist for the cultivation and export of high value vegetables the rural farmers enjoy higher prices and better profit margins. Though the domestic market has been improving very slowly this crop sector has the potential to expand incomes along the whole supply chain from farmer to consumer. Awareness programmes should be conducted to increase the domestic market demand because the younger generation needs knowledge of consuming fresh vegetables as salads. This will help increase the nutritional value of daily diets and improve the health of consumers. There is a market potential for various types of salad lettuce, bell pepper, cauliflower, broccoli and cucumber.

CHAPTER THREE

Value Chain Analysis of High Value Vegetables Sub Sector

3.1 Introduction

After the market liberalization in Sri Lanka, the capacity of governments to regulate commodity markets has reduced. As a result, the private sector entered the market gradually and a significant transformation in commodity supply chains was observed. This transformation was faster due to globalization because the stakeholders tried to be aware of the diversification of commodities such as processing, branding and packaging. The process of domestic market liberalization and integration into the global trade system has had a number of positive effects such as exposing producers in developing countries to international market price signals, contributing to a better allocation of resources and encouraging the influx of private capital. (FAO, December 2007).

As Sri Lanka is an agricultural country the rural farmers know how to use the resources in the related areas where there are excellent soil and temperate climate when supplemented with irrigation. Farmers in Bandarawela, Welimada and Nuwara Eliya areas entered into cultivation of a wide range of high value crops. Agricultural education and research stations were strong in the past in identifying and enhancing opportunities in agricultural production. At the same time, the country faces the serious challenge of moving away of youth engaging in agricultural activities. When the youth migrated from rural areas a significant labour shortage emerged. Despite these challenges, the revitalization of the fruits and vegetables sector is identified as a potential mechanism for reducing poverty in the rural areas. Most of the people in the area were engaged in agriculture. After introducing this high value crop sector, youth and the housewives start engaging in agriculture and agribusiness as well. Therefore increasing the production of high value vegetables resulted in the increase of incomes of producers, collectors and other stakeholders in the supply chain. There is an excellent climate and soil for vegetable cultivation in Bandarawela and Nuwara Eliya. By using irrigated agriculture, poly tunnels and packing materials the products gained a higher value. With the intention of studying the Value Chain of High Value agricultural sector as a whole, crops under poly tunnels and open field were identified. Accordingly the most common crops in these two areas were selected. They were bell pepper, iceberg, Chinese cabbage, cucumber, lettuce, cauliflower and broccoli.

There is a huge competition among the stakeholders engaged in the entire chain activities from inputs of raw materials to marketing of final goods. The competitiveness of the private sector depends on how well the market is organized and maximizes the productivity along the supply chain. This chapter tries to understand the characteristics and inefficiencies of specific high value vegetable value chains.

There were several factors considered for selecting this study to analyze the specific value chains. Initially, all these high value highly perishable products have proved that these products increased farm income and income of other stakeholders. The government decided that it is necessary to increase the vegetable intake and this is a better way to expand the sector. Farmers have been cultivating some of these crops for about 10 years or more. But the expansion of cultivation has been very slow and almost all the crops are not available at most of the urban markets. In addition, though this crop sector improved gradually there was no database available to study in detail. These products gained a fair representation of this crop sector because cultivation of crops was separated according to the locality. The researcher decided to study this vegetable sector, after spending a significant time period of finding secondary data and concluded that there were only two marketing channels in the country but there was not enough data available for further study.

Bell pepper and tomato are considered highly profitable vegetables for farmers in the Uva Paranagama area. These two crops are grown in poly tunnels and use hybrid seed varieties. Hence the yield, quality and the appearance gained a higher demand and higher price. In addition farmers have successfully entered in high value leafy crop sector and grown iceberg, lettuce, Pak Choy, red cabbage etc. Farmers in Nuwara Eliya also cultivate these crops and cauliflower and broccoli too. Compared to the cultivation of lettuce in Uva Paranagama area it is lower than that in Nuwara Eliya. Many farmers grow leafy lettuce in the edge of their vegetable beds. But high value other lettuce varieties are grown as mixed cropping with high value vegetables and herbs. Most of these crops are directed to export market but it is not necessarily focused on the export market because there will be an expanded demand for tourist hotels with the development of the sector.

3.2 Institutional Support

For the development of high value agricultural sector in the country the Department of Agriculture, Export Development Board and the Fruits and Vegetable Producers, Processors and Exporters' Association, Agricultural Cooperatives and supermarkets have given the institutional support on technical and research. There are a few associations to support farmers in the major producing areas and they provide technical knowhow and main inputs such as seed and agro chemicals in time. For supplying these items to the export market new regulatory and institutional framework for food safety and phytosanitary measures need to be concerned.

3.3 Value Chain Analysis of High Value Highly Perishable Vegetables

For the analysis of this crop sector many growers and several processors for each produce were interviewed without considering the quantity of supply. The value chain analysis was based on averaging the responses received from the interviewed

stakeholders. The crops of this sector can be grouped according to the areas in which they are cultivated, the techniques used and the crops which are grown as mixed cropping. According to that bell pepper and tomato are analyzed as cultivation under poly tunnels, lettuce, iceberg and Pak Choy as mixed cropping and green cucumber, Chinese cabbage, cauliflower and broccoli as single crops. These crops are destined for four major market segments such as supermarkets, hotels, retail markets and export market. All the crops are sorted according to the need of the above mentioned market segments. The prices, mode of transport and packing vary according to the requirement.

The value chain for all these fresh vegetables is divided into four to five distinct activities or functions.

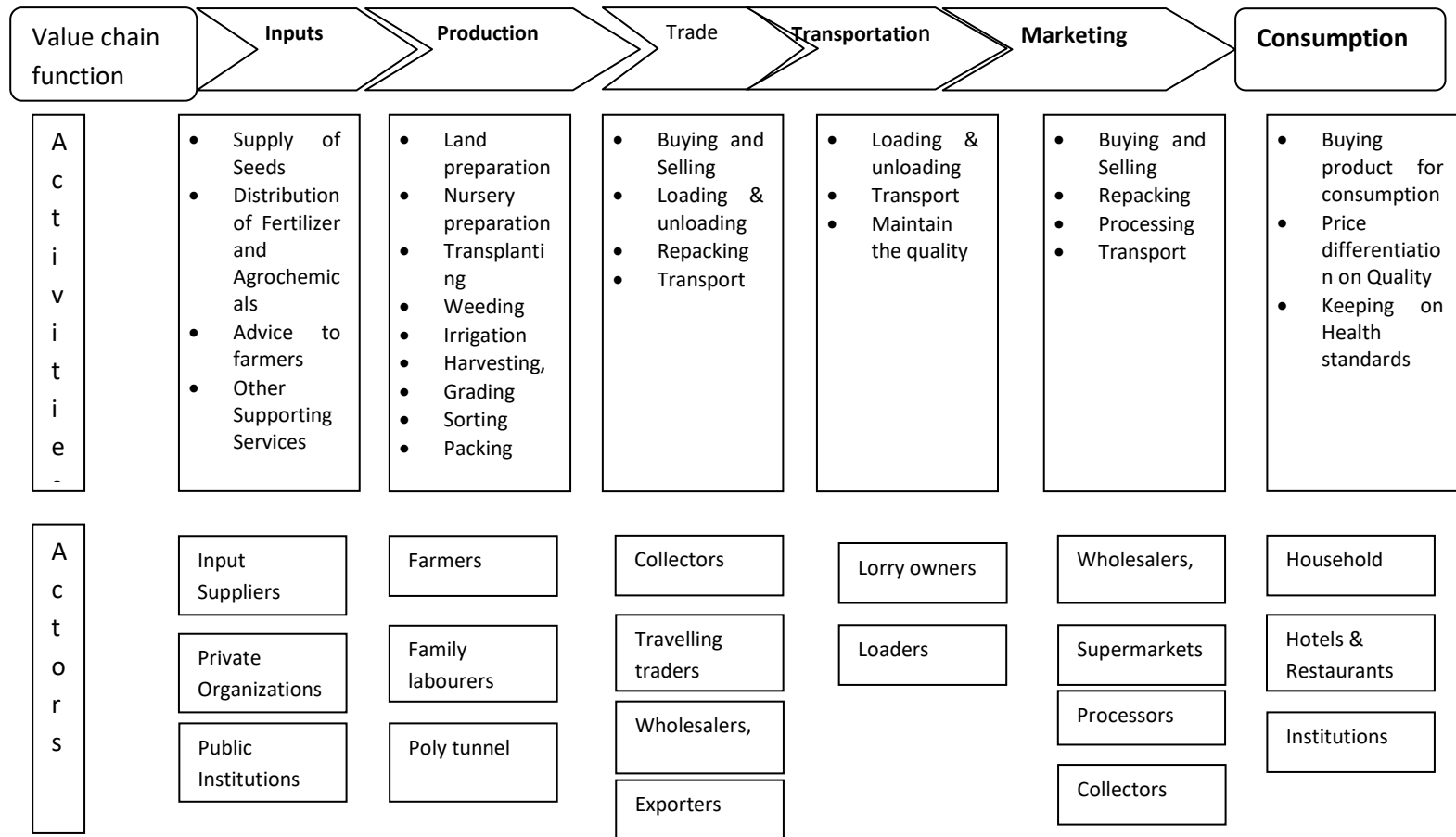

Source: Survey information

Figure 3.1: Input Supplies and Distribution System

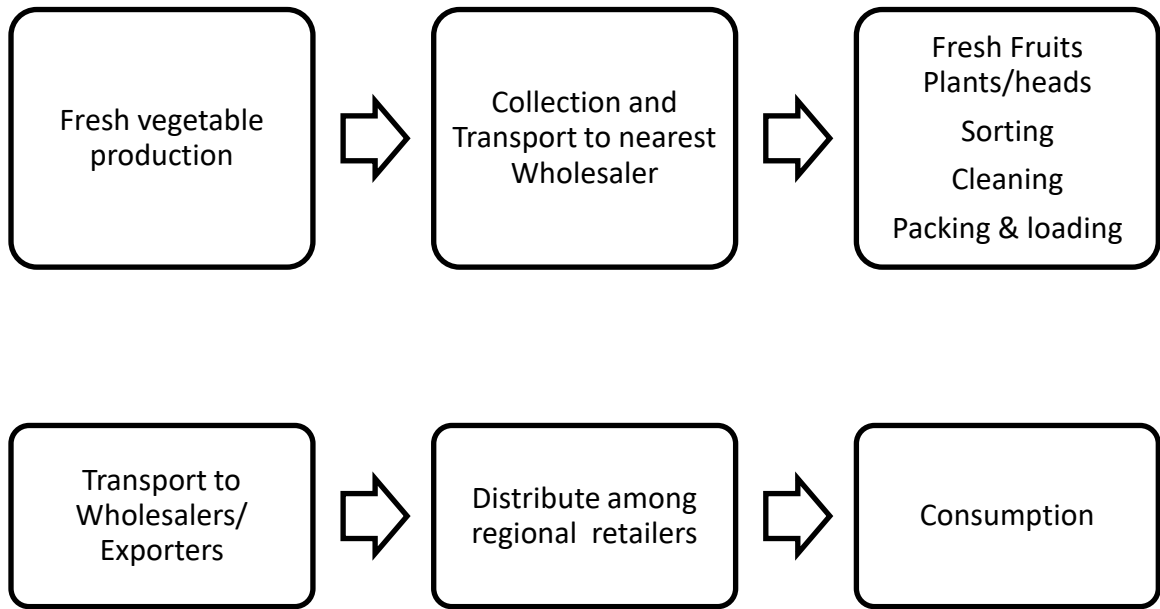
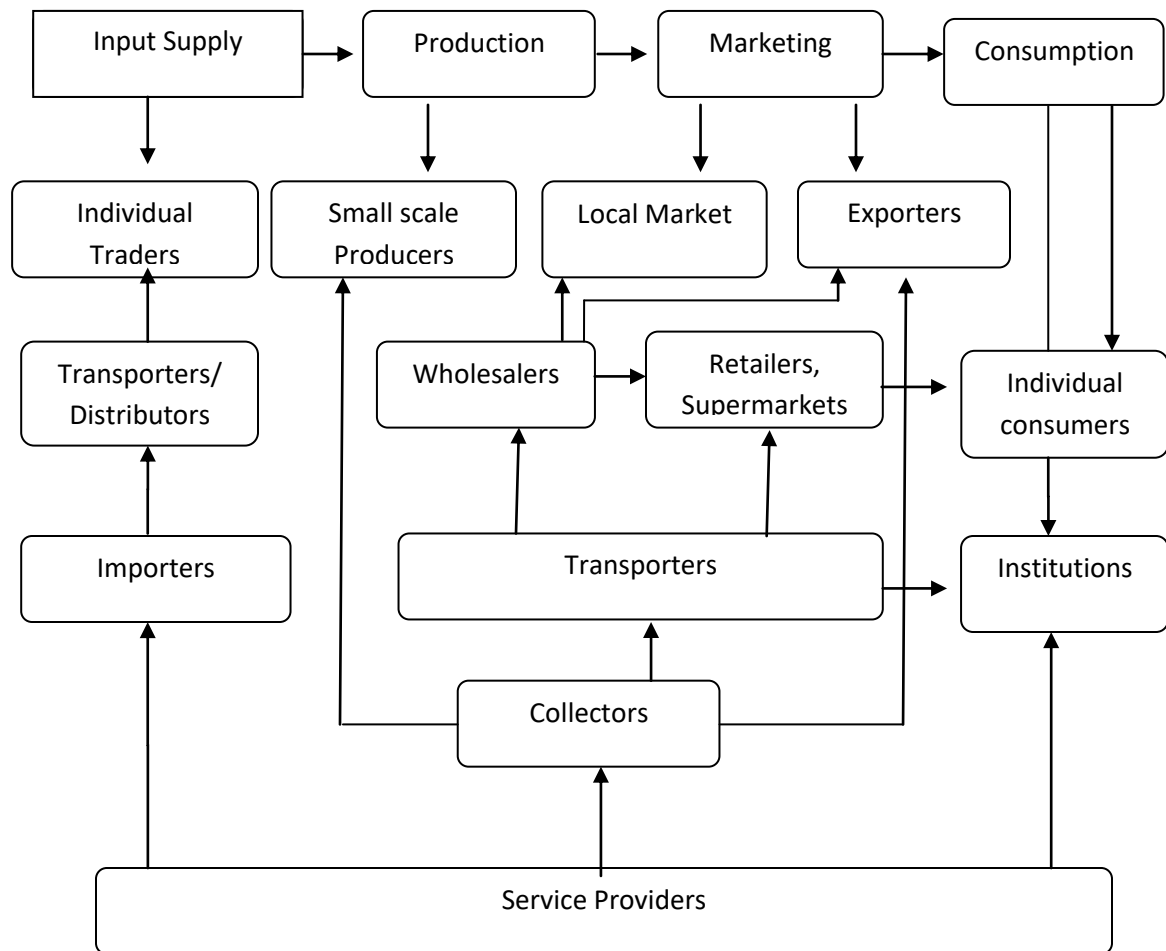

Figure 3.2: Main Activities throughout the Supply Chain



Source: Survey information

Figure 3.3: Value Chain Map of High Value Vegetables

The collectors in the producing areas normally retain a 25 percent gross margin for their investment on bell pepper trading. This margin varies from 15 – 25 percent earlier but this margin has declined when some more traders entered the trade. This gross margin varies according to the supply and demand and also the risk factor. Sometimes wholesalers in the urban areas reject 10 – 25 percent of the total supplies and payments are made for the accepted quantities only. Therefore collectors keep higher margin while selling to the wholesalers. Not only bell pepper, supply of all other crops under this high value highly perishable crop sector is traded on this basis. To minimize the damages the supply chain is kept very short and supplies are distributed to the final destination as soon as possible. When the supply chain was very short the chain actors get higher profit margins. The producers are also satisfied with their earnings because they are able to cover up their cost and minimize the risk. Bell pepper producers get about 40 to 64 percent of the consumer rupee. Collectors sell directly to the exporters, tourist hotels and some retailers in urban areas. Sometimes they distribute the produce to the wholesalers in urban areas and regional collecting centres of the supermarkets.

When the supply chain is too short the collector's margin is high. The gross margin between producer price and the retail price is divided between the collector and the wholesaler when wholesalers enter the channel. The following table shows the price spread of bell pepper. It clearly shows that the producer's share of yellow and red bell pepper was over 50 percent and higher than that of green bell pepper.

Table 3.1: Price Spread between Producer and Consumer as a % of Consumer Rupee

Item	Bell Pepper -Green	Bell pepper - Red	Bell pepper - Yellow
Producers' Share	40	50	64
Collectors' margin	20	11	7
Wholesalers' margin	5	11	14
Retailers' margin	35	28	15
Total	100	100	100

Source: Survey data

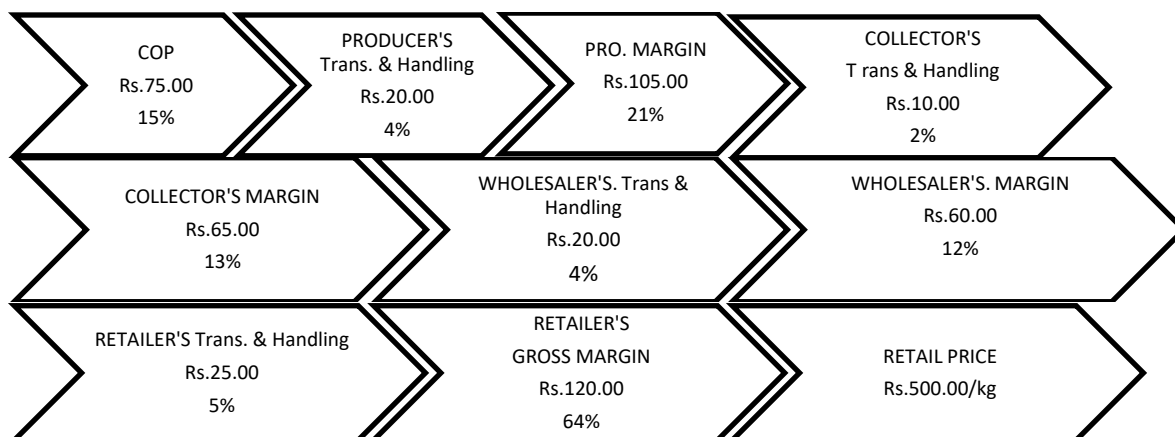

Figure 3.4: Value Chain of Bell Pepper - Green (Rs/kg)



Figure 3.5: Value Chain of Bell Pepper – Red & Yellow (Rs/kg)

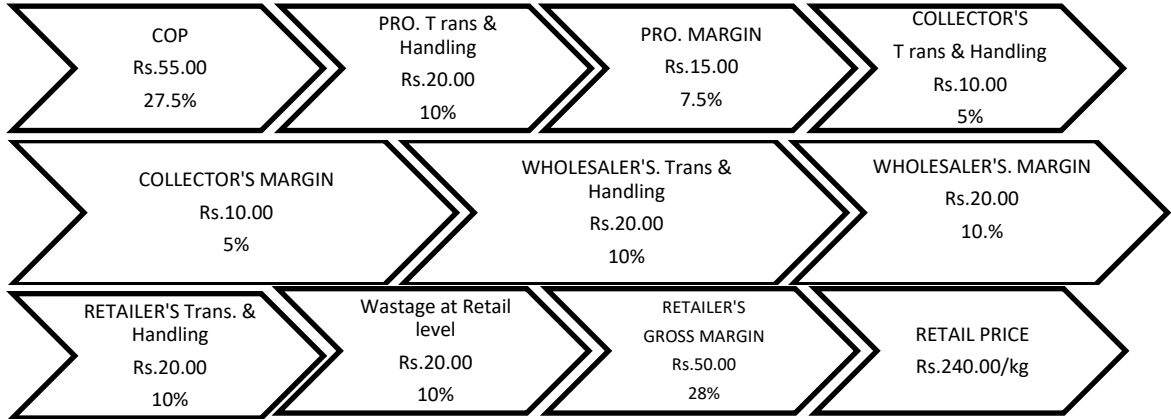

Figure 3.6: Value Chain of Tomato (Poly tunnels) (Rs/kg)



Figure 3.7: Value Chain of Green Cucumber (Rs/kg)

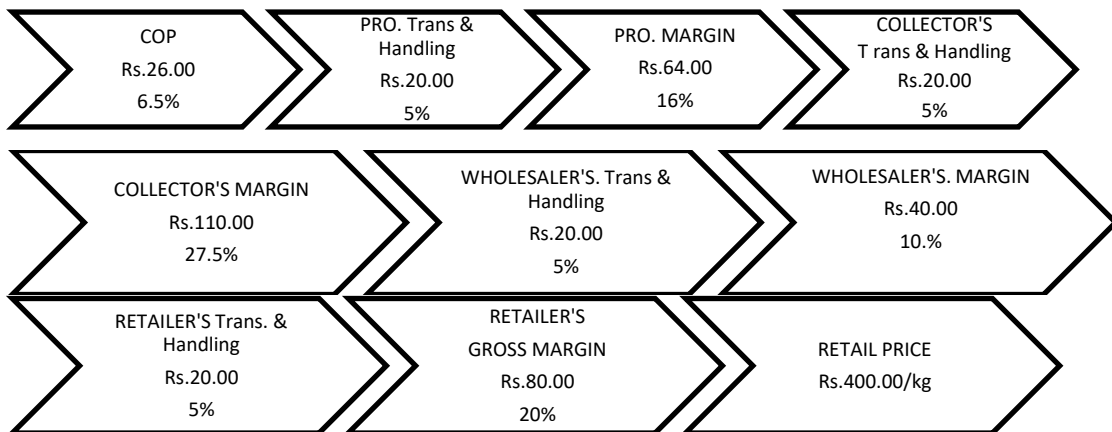

Figure 3.8: Value Chain of Iceberg (Rs/kg)

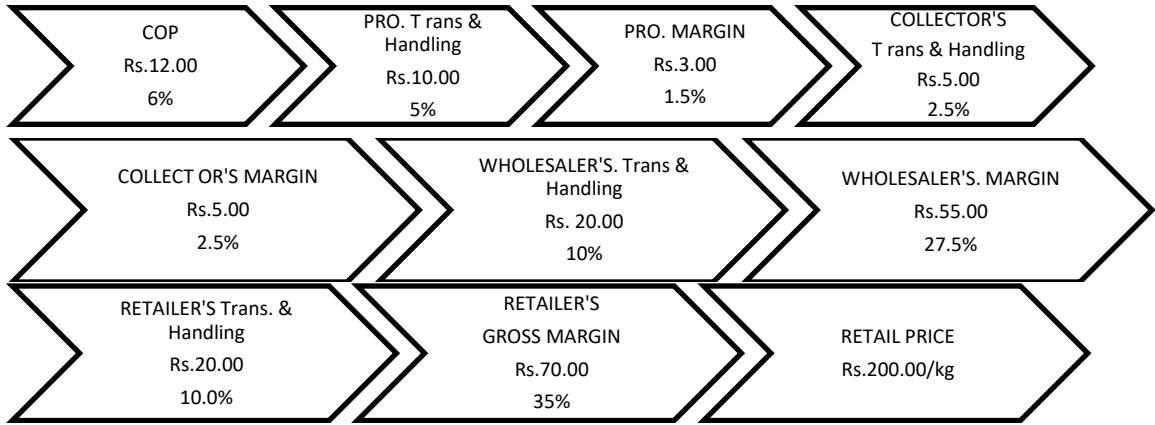

Figure 3.9: Value Chain of Lettuce – Green (Rs/kg)

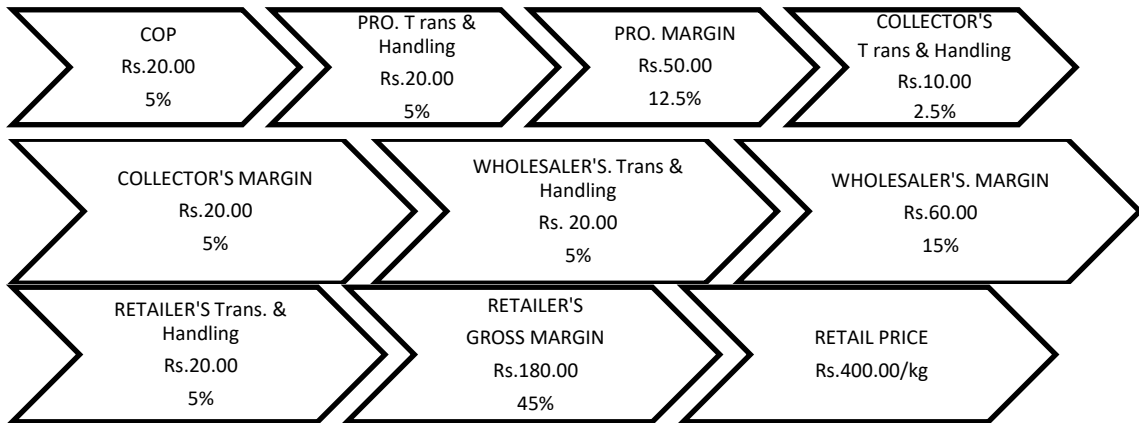

Figure 3.10: Value Chain of Lettuce - Red (Rs/kg)

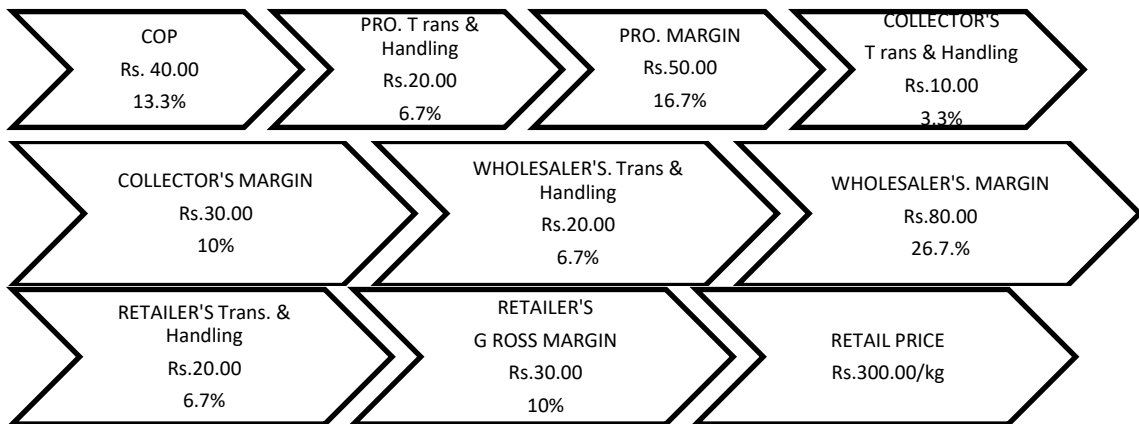

Figure 3.11: Value Chain of Chinese Cabbage (Rs/kg)

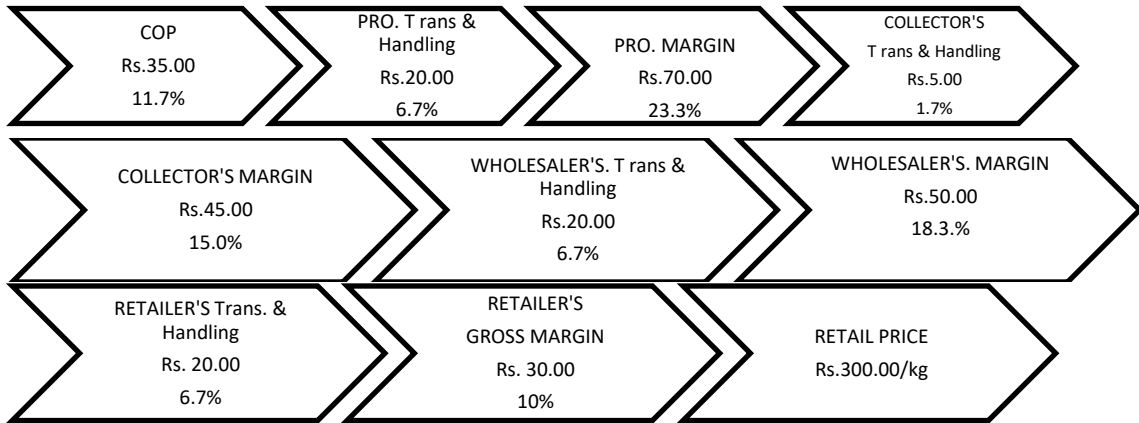

Figure 3.12: Value Chain of Cauliflower (Rs/kg)

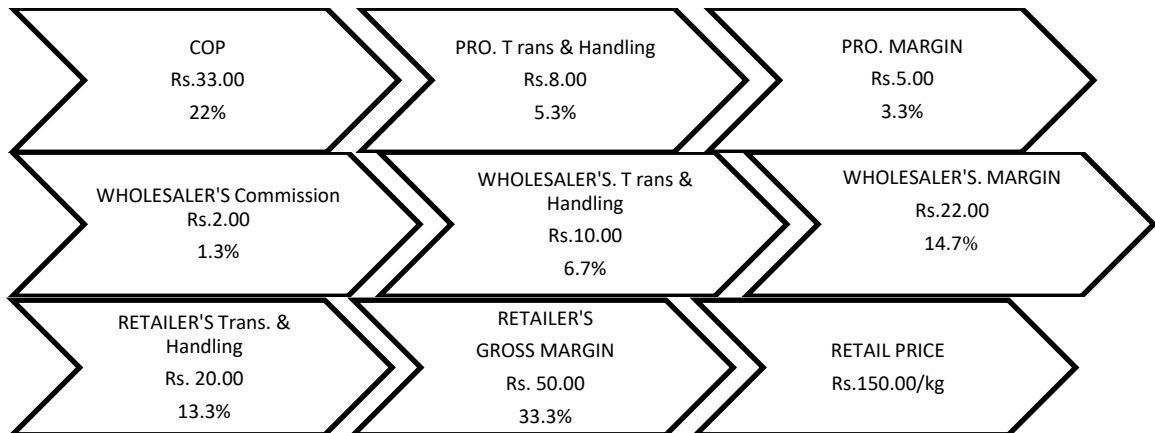

Figure 3.13: Value Chain of Cauliflower – Dambulla (Rs/kg)



Figure 3.14: Value Chain of Broccoli (Rs/kg)

The collectors/wholesalers in Bandarawela retained a 25 to 35 percent gross margin by selling bell pepper to Colombo market. They retained this higher margin because the wholesalers made payments only for good quality products. The rejection quantity was about 10-25 percent of the total sales. Collectors retained about 19-20 percent gross profit margin for bell pepper. The damages were higher for red and yellow bell pepper because they were ripening peppers. When the damages were around 10 percent the profit margin of traders had dropped to 5 - 6 percent.

They retained about 45 to 55 percent gross margin while selling tomato because they had to incur the loss of wastages. The cost of production of tomato was about 27 percent of the retail price and when collector directly sells, he retained about 30 percent margin. The retailers of tomato kept about 21 percent of the retail price.

The producers' margin for bell pepper varied from 21 to 36 percent out of retail price. In the service sector retailers retained the highest margin which was about 25 percent of the retail price. The collectors and wholesalers got about 8 to 13 percent margins out of retail price. The risk for selling at collectors' and the wholesalers' levels are very low compared to that at the retail level. At the retail level products were moving very slowly due to very limited demand from consumers. The highest margin (32 percent) out of retail price of green cucumber was retained by the collectors followed by retailers (22 percent).

Green lettuce and Pak Choy were cultivated at the edges of the main cropping beds. Hence the cost of cultivation of these crops was very low compared to that of other crops. Producer's margin for red lettuce, Pak Choy and iceberg varied from 12.5 to 16 percent of the retail price while that of green lettuce was about 2 percent. The highest margin is retained by the retailers due to high wastage. While selling lettuce wholesalers retained a higher margin compared to that of collectors. Iceberg and Pak Choy collectors retained higher margins to minimize their losses because most of the supplies reached supermarkets, hotels and restaurants. They paid only for good quality supplies. Iceberg collectors retained about 28 percent margin. When the retailers bought from the collectors directly, both of them retained higher margins.

The producers of cauliflower and broccoli received a 35 and 24 percent margin of the retail price respectively while it is about 16 percent for Chinese cabbage. The wholesalers got about 20 to 27 percent margins out of the retail prices of these crops. Both the retailers of cauliflower and Chinese cabbage kept about 10 percent of the retail price while broccoli retailers retained about 16 percent of the retail price. The transport and handling cost of these commodities were more or less equal and it was about Rs.20.00 per kg. To minimize the handling and transport cost of plastic crates producers used corrugated cardboard boxes to pack cauliflower and broccoli. Transporters and collectors who delivered produce to the hotels, restaurants, supermarkets and other retail stalls directly used plastic crates to minimize the damages. Lettuce supplied to the

local market was not packed in the proper way. They were wrapped in poly sacks and their damages were very high compared to other commodities.

In Dambulla, cauliflower farmers received a very low margin compared to that of Nuwara Eliya farmers. The demand for cauliflower supplied from Dambulla was very high in the market because consumers were able to afford. In addition cauliflower was supplied to the market from Kalpitiya area too. Prices of these cauliflowers were also very low compared to that of Nuwara Eliya product.

Table 3.2: Gross Margin of Cauliflower at Dambulla Market -2012

Month	Producer Price Range(Rs/kg)		Average Producer Price	Wholesale price Dambulla (Rs/kg)		Average Wholesale Price	Gross Margin (Rs/kg)	Mark up as a % of Producer Price
May w1	97.00	100.00	98.50	100.00	105.00	102.50	4.00	4.1
w2	82.00	95.00	88.50	85.00	98.00	91.50	3.00	3.4
w3	77.00	92.00	84.50	80.00	95.00	87.50	3.00	3.6
w4	75.00	87.00	81.00	78.00	90.00	84.00	3.00	3.7
Jun w1	72.00	83.00	77.50	75.00	85.00	80.00	2.50	3.2
w2	60.00	67.00	63.50	62.00	70.00	66.00	2.50	3.9
w3	43.00	55.00	49.00	45.00	57.00	51.00	2.00	4.1
w4	40.00	48.00	44.00	42.00	50.00	46.00	2.00	4.5
Jul w1	35.00	44.00	39.50	37.00	45.00	41.00	1.50	3.8
w2	33.00	40.00	36.50	35.00	42.00	38.50	2.00	5.5
w3	25.00	30.00	27.50	27.00	33.00	30.00	2.50	9.1
w4	28.00	33.00	30.50	30.00	38.00	34.00	3.50	11.5
Aug w1	35.00	46.00	40.50	38.00	48.00	43.00	2.50	6.2
w2	38.00	48.00	43.00	40.00	50.00	45.00	2.00	4.7
w3	43.00	53.00	48.00	45.00	55.00	50.00	2.00	4.2
w4	50.00	58.00	54.00	52.00	63.00	57.50	3.50	6.5
Sep w1	55.00	67.00	61.00	57.00	70.00	63.50	2.50	4.1
w2	58.00	67.00	62.50	60.00	70.00	65.00	2.50	4.0

Source: Survey data 2012

In Dambulla Dedicated Economic Centre, prices of cauliflower were very low in July and August because of the harvesting season of cauliflower in Dambulla area. Normally wholesalers in Dambulla DEC draw about Rs.2.00 per kg as commission. The highest mark-up between producer price and wholesale price was recorded in the latter part of July when the highest supply reached the market. During the other months mark-up is about 4 percent.

Table 3.3: Value Chain of Cauliflower and Broccoli

Item	Cauliflower		Broccoli	
	Value Addition (Rs/kg)	Margin as a % of Retail Price	Value Addition (Rs/kg)	Margin as a % of Retail Price
Cost of Production	35.00	11.7	44.00	13.8
Producer's Transport and handling charges	20.00	6.7	20.00	6.3
Producer's margin	70.00	23.3	76.00	23.8
Collector's Transport and handling charges	5.00	1.7	5.00	1.6
Collector's margin	45.00	15.0	5.00	1.6
Wholesaler's Transport and handling charges	20.00	6.7	20.00	6.3
Wholesaler's margin	55.00	18.3	80.00	25.0
Retailer's Transport and handling charges	20.00	6.7	20.00	6.3
Retailer's margin	30.00	10.0	50.00	15.6
Retail Price	300.00	100.0	320.00	100.0

Source: Survey data

Table 3.4: Value Chain of Cauliflower – Supplied from Dambulla to Narahenpita DEC

Item	Cauliflower - Dambulla to Narahenpita DEC	
	Value addition (Rs/kg)	Margin as a % of retail Price
Cost of Production	30.00	20.0
Producer's Transport and handling charges	5.00	3.3
Producer's margin	11.00	7.3
Wholesaler's margin	2.00	1.3
Wholesaler's Transport and handling charges	10.00	6.7
Wholesaler's margin	22.00	14.7
Retailer's Transport and handling charges	20.00	13.3
Retailer's margin	50.00	33.3
Retail Price	150.00	100.0

Source: Survey data 2012

These tables show that the retailers' profit margin by selling cauliflower which is produced in Dambulla area was higher than that is supplied from Nuwara Eliya area. The Nuwara Eliya producers' profit margin of supplying cauliflower was about five times

higher than that of Dambulla farmers. At the retail markets cauliflower supplied from Nuwara Eliya was sold at higher prices. The demand for Dambulla produce is relatively higher from consumers as well as hotels due to lower prices. As the demand is high retailers retain a higher margin.

Table 3.5: Value Chain of Chinese Cabbage and Iceberg

Item	Chinese Cabbage		Iceberg	
	Value Addition (Rs/kg)	Margin as a % of Retail Price	Value Addition (Rs/kg)	Margin as a % of Retail Price
Cost of Production	40.00	13.3	26.00	14.0
Producer's Transport and handling charges	20.00	6.7	20.00	4.0
Producer's margin	50.00	16.7	64.00	6.0
Collector's Transport and handling charges	10.00	3.3	20.00	4.0
Collector's margin	30.00	10.0	110.00	32.0
Wholesaler's Transport and handling charges	20.00	6.7	20.00	8.0
Wholesaler's margin	80.00	26.7	40.00	2.0
Retailer's Transport & handling charges	20.00	6.7	20.00	8.0
Retailer's margin	30.00	10.0	80.00	22.0
Retail Price	300.00	100.0	400.00	100.0

Source: Survey data 2012

Field level collectors retain higher margins while selling iceberg because it has a specific demand at farm level. Though farmers are aware of this situation they sell their produce to the collectors because this is the only way they have to sell their produce. These products are sold on contract basis.

Table 3.6: Value Chain of Bell Pepper

Item	Bell Pepper Green		Bell Pepper – Red & Yellow	
	Value Addition (Rs/kg)	Margin as a % of Retail Price	Value Addition (Rs/kg)	Margin as a % of Retail Price
Cost of Production	75	15	80.00	11.4
Producer's Transport and handling charges	20	4	20.00	2.9
Producer's margin	105	21	250.00	35.7
Collector's Transport and handling charges	10	2	10.00	1.4
Collector's margin	65	13	65.00	9.3
Wholesaler's Transport and handling charges	20	4	20.00	2.9
Wholesaler's margin	60	12	55.00	7.9
Retailer's Transport and handling charges	25	5	25.00	3.6
Retailer's margin	120	24	175.00	25.0
Retail Price	500	100	700.00	100.0

Source: Survey data 2012

Bell pepper farmers receive about 21 to 36 percent out of the retail price and the farmers mentioned that it is a good income source. Retailer's margin is about 24-25 percent out of the retail price and wastages are about 10 percent at the retail level. Hence they retain this higher margin.

Poly tunnel tomato growers' profit margin is comparatively low due to open field tomato cultivation. At present almost all tomato farmers use hybrid seeds and quality of the produce is very high. Hence the poly tunnel produces cannot be differentiated at wholesale and retail levels. Therefore poly tunnel tomato cultivation has declined according to the growers. Farmers in Welimada and Bandarawela areas cultivate green cucumber which is called salad cucumber and farmers get about 6 percent out of the retail price. Collectors reserve higher margins which are about 32 percent out of retail price while that of retailers' is about 22 percent.

Table 3.7: Value Chain of Tomato and Green Cucumber

Item	Tomato (Poly tunnels)		Green cucumber	
	Value Addition (Rs/kg)	Margin as a % of Retail Price	Value Addition (Rs/kg)	Margin as a % of Retail Price
Cost of Production	55.00	27.5	35.00	14.0
Producer's Transport and handling charges	20.00	10.0	10.00	4.0
Producer's margin	15.00	7.5	15.00	6.0
Collector's Transport and handling charges	10.00	5.0	10.00	4.0
Collector's margin	10.00	5.0	80.00	32.0
Wholesaler's Transport and handling charges	20.00	10.0	20.00	8.0
Wholesaler's margin	20.00	10.0	5.00	2.0
Retailer's Transport & handling charges	20.00	10.0	20.00	8.0
Retailer's margin	70.00	30.8	55.00	22.0
Retail Price	240.00	100.00	250.00	100.0

Source: Survey data 2012

Compared to lettuce, Pak Choy producer's profit margin is higher for Pak Choy farming. Since lettuce green and Pak Choy are cultivated on the edge of the vegetable beds the cost of cultivation is very less. But this calculation is done as a mono crop. The farmers who cultivate lettuce and Pak Choy mentioned that they cultivate these crops to maximize their farm income as well as profit margin. Red lettuce cultivation is fairly profitable because the demand for this produce is very specific. Mainly supermarkets and exporters buy their produce. As these items are highly perishable the retailers reserve very high margins to minimize their losses. The retailer's margin for green lettuce and red lettuce is 35 and 45 percent out of retail price while that is 23 percent for Pak Choy.

Table 3.8: Value Chain of Lettuce and Pak Choy

Item	Lettuce - Green		Lettuce - Red		Pak Choy	
	Value Addition (Rs/kg)	Margin as a % of Retail Price	Value Addition (Rs/kg)	Margin as a % of Retail Price	Value Addition (Rs/kg)	Margin as a % of Retail Price
Cost of Production	12.00	6.0	20.00	5.0	15.00	6.8
Producer's Transport and handling charges	10.00	5.0	20.00	5.0	10.00	4.5
Producer's margin	3.00	1.5	50.00	12.5	35.00	15.9
Collector's Transport and handling charges	5.00	2.5	10.00	2.5	15.00	6.8
Collector's margin	5.00	2.5	20.00	5.0	29.00	13.2
Wholesaler's Transport & handling charges	20.00	10.0	20.00	5.0	20.00	9.1
Wholesaler's margin	55.00	27.5	60.00	15.0	25.00	11.4
Retailer's Transport and handling charges	20.00	10.0	20.00	5.0	20.00	9.1
Retailer's margin	70.00	35.0	180.00	45.0	51.00	23.2
Retail Price	200.00	100.0	400.00	100.0	220.00	100.0

Source: Survey data 2012

Considering the average prices of high value highly perishable vegetables in the Bandarawela and Nuwara Eliya areas and major consuming areas of Colombo, the following results were identified. The following tables show that the highest producer's share is for yellow bell pepper followed by red bell pepper. Considering the leafy vegetables the highest share goes for Chinese cabbage followed by iceberg. Broccoli and cauliflower farmers get 44 and 41 percent from Nuwara Eliya area while the share of cauliflower farmers in Dambulla is 31 percent of the retail price. The wholesalers in Nuwara Eliya area retain a higher margin because many of them distribute these produce among the outstation retailers. Due to the highly perishable nature the collectors cum wholesalers distribute this produce among retail outlets in distant urban cities by limiting loading and unloading functions. The leafy vegetable retailers reserve higher margins to minimize their losses due to drying, as hot climate prevailing in urban cities in Colombo, Galle, Matara and Hambantota, where there is higher demand, rapidly turns the outer leaves pale. Retailers of bell pepper retain higher margins to avert the losses because the daily demand is very low and they keep this produce about three to four days.

Table 3.9: Price Spread of High Value Highly Perishable Vegetables (%)

Item	Iceberg	Cauliflower N' Eliya	Cauliflower-Dambulla	Broccoli	Chinese Cabbage
Producers' Share	28	41	31	44	37
Collectors' margin	33	17	1	3	13
Wholesalers' margin	15	25	21	31	33
Retailers' margin	24	17	47	22	17
Total	100	100	100	100	100

Source: Survey data 2012

Table 3.10: Price Spread of High Value Highly Perishable Vegetables (%) – Continued

Item	Bell Pepper – Green	Bell pepper Red	Bell pepper Yellow	Tomato	Cucumber -Green
Producers' Share	40	50	64	38	20
Collectors' margin	20	11	7	8	40
Wholesalers' margin	5	11	14	4	15
Retailers' margin	35	28	15	50	25
Total	100	100	100	100	100

Source: Survey data 2012

Table 3.11: Price Spread of High Value Highly Perishable Vegetables (%) – Continued

Item	Pak Choy	Lettuce - Red	Lettuce - Green
Producers' Share	27	23	13
Collectors' margin	20	8	5
Wholesalers' margin	21	20	37
Retailers' margin	32	49	45
Total	100	100	100

Source: Survey data 2012

Earlier the distribution system of vegetables from producer to consumer caused very high post-harvest losses due to lack of proper transport. After introducing tax and other incentives for agricultural sector, mainly for duty free imports of capital goods, the distribution system improved rapidly by reducing wastages. The present system of distribution from the producer to the consumer of vegetables helped the consumers to purchase good quality produce from green vegetable stalls as well as from supermarkets. Consumers have become increasingly conscious of good quality at the retail end of the supply chain. Therefore transporters of these produces use their experiences to improve the product quality and minimize the losses during transportation.

As the opportunities exist for the cultivation and export of high value vegetables the rural farmers enjoy higher prices and better profit margins. In addition, the domestic market has been improving very slowly as this crop sector has the potential to expand incomes along the whole supply chain from farmer to consumer. Awareness programmes should be conducted to increase the domestic market demand which will help increase the nutritional value of daily foods and improve the health of consumers.

The gross margin of cauliflower and broccoli producer is about 42 and 30 percent of the retail price. Producers use their farming experience to minimize the cost of production. They use cardboard boxes and plastic crates for packaging and use proper transport which can reduce the damages. Chinese cabbage, iceberg and Pak Choy farmers gained 20 – 24 percent out of the retail price and to minimize the cost of production farmers use their own cultivation practices. Some of the producers sell their produce at the farm to minimize the cost of transport and save their time for other crop management. Gross margin for bell pepper varies from 25 to 39 percent out of the retail price. The well experienced farmers maintain the crop properly to obtain higher yields and produce good quality bell pepper. Their income is much higher than that of other small scale producers.

Table 3.12: Cost of Production and Gross Margins at Various Levels as a Percentage of Retail Price

Value Addition	Cauliflower NE	Broccoli	Chinese cabbage	Green cucumber	Bell pepper green	Bell pepper red	Tomato	Lettuce green	Lettuce red	Iceberg	Pak Choy	Cauliflower Dambulla
COP	11.7	13.8	13.3	14	15	11.4	27.5	6	5	6.5	6.8	20
Producer's Cost & margin	30.0	43.8	36.7	24.0	40.0	50.0	45.0	12.5	22.5	27.5	27.3	30.6
Collector's margin	16.7	3.1	13.3	36.0	15.0	10.7	10.0	5.0	7.5	32.5	20.0	1.3
Wholesaler's margin	25.0	31.3	33.3	10.0	16.0	10.7	20.0	37.5	20.0	15.0	20.5	21.4
Retailer's margin	16.7	21.9	16.7	30.0	29.0	28.6	40.8	45.0	50.0	25.0	32.3	46.7
COP	11.7	13.8	13.3	14	15	11.4	27.5	6	5	6.5	6.8	20
Gross Profit of producers	23.3	30.0	23.4	10.0	25.0	38.6	17.5	6.5	17.5	21.0	20.5	10.6

Source: Survey data 2012

The following figures clearly show that these crops provide a high income to the farmers in those areas. Almost all the farmers mentioned that cultivation of these crops is very profitable. The transport and handling cost are very higher compared to that of other vegetables.

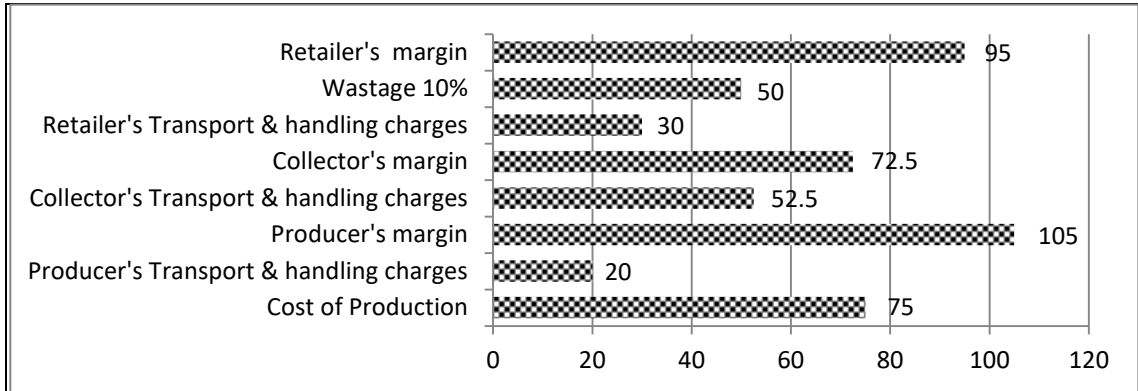

Source: Survey data 2012

Figure 3.15: Value Addition of Bell Pepper - Green

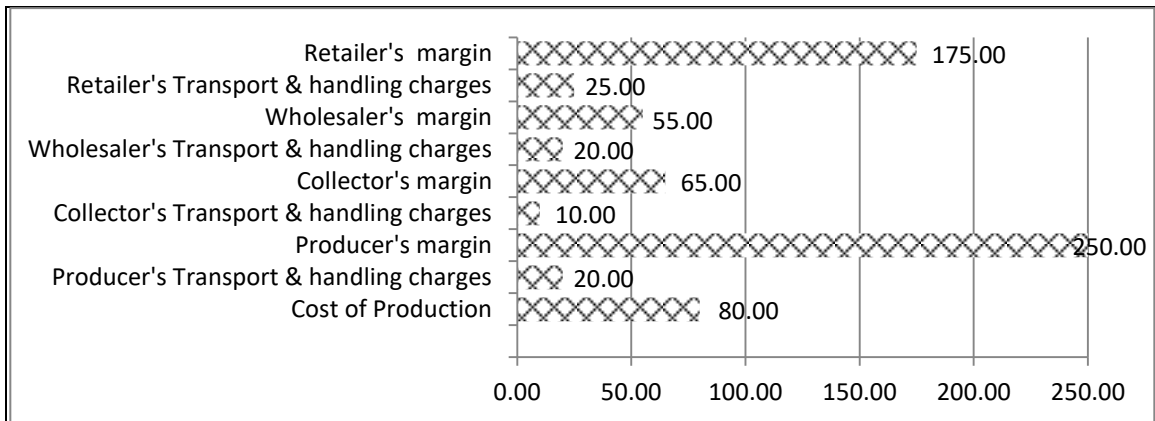

Source: Survey data 2012

Figure 3.16: Value Addition of Bell Pepper Red & Yellow (Rs/kg)

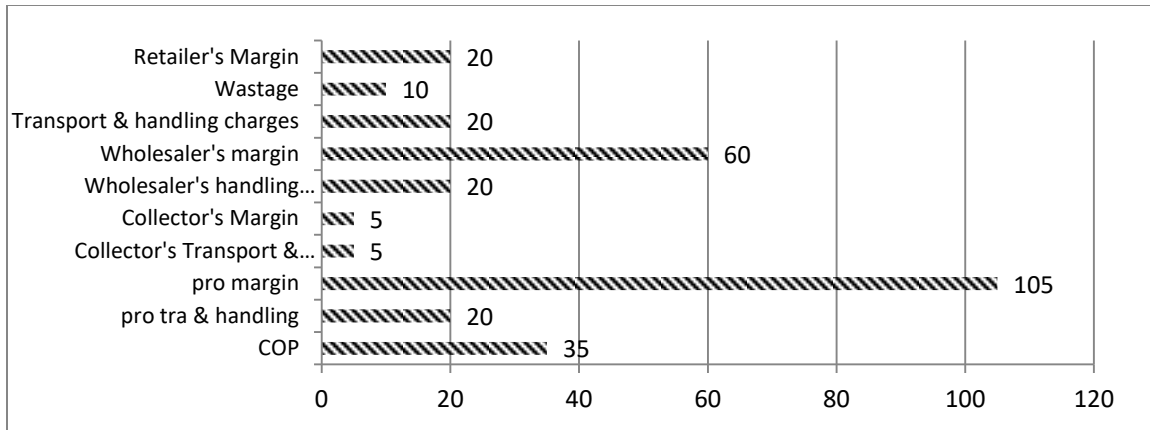

Source: Source: Survey data 2012

Figure 3.17: Value Addition of Cauliflower – Nuwara Eliya (Rs/kg)

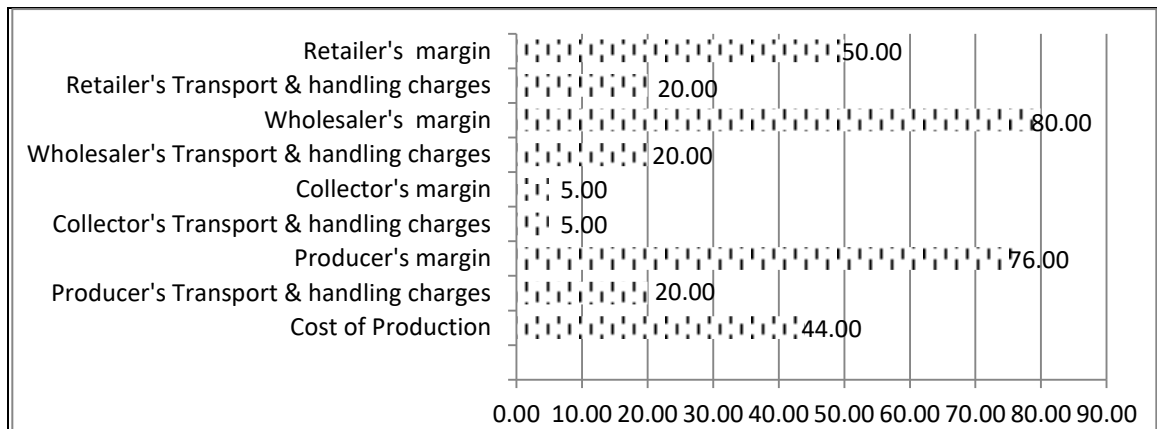

Source: Source: Survey data 2012

Figure 3.18: Value Addition of Broccoli (Rs/kg)

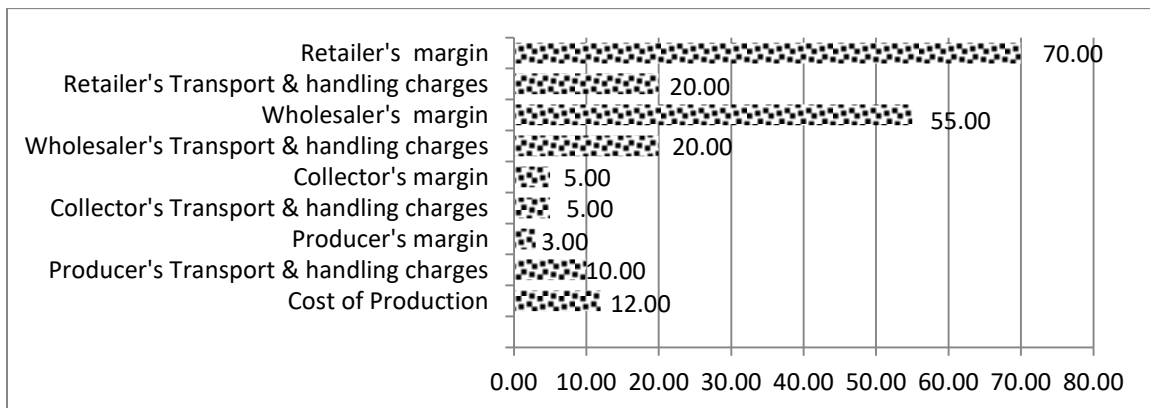

Source: Source: Survey data 2012

Figure 3.19: Value Addition of Lettuce – Green (Rs/kg)

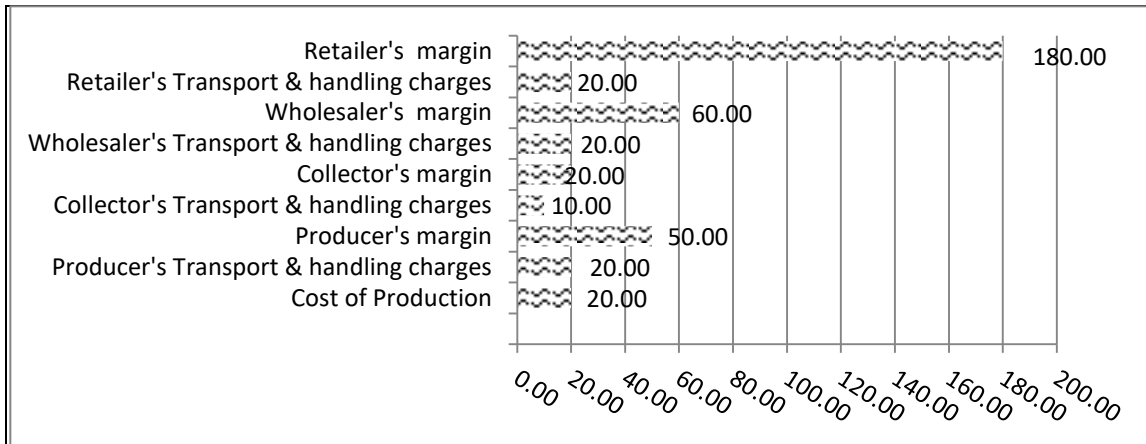

Source: Source: Survey data 2012

Figure 3.20: Value Addition of Lettuce – Red

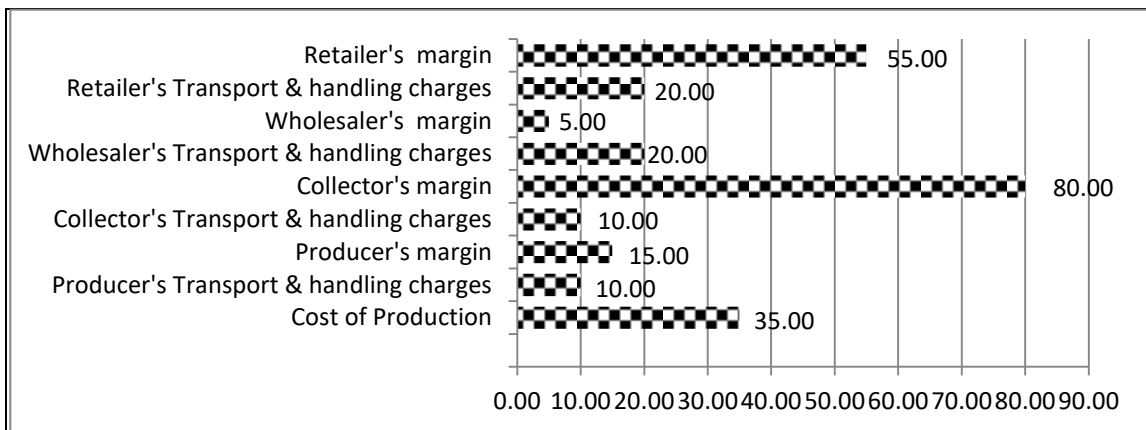

Source: Source: Survey data 2012

Figure 3.21: Value Addition of Green Cucumber (Rs/kg)

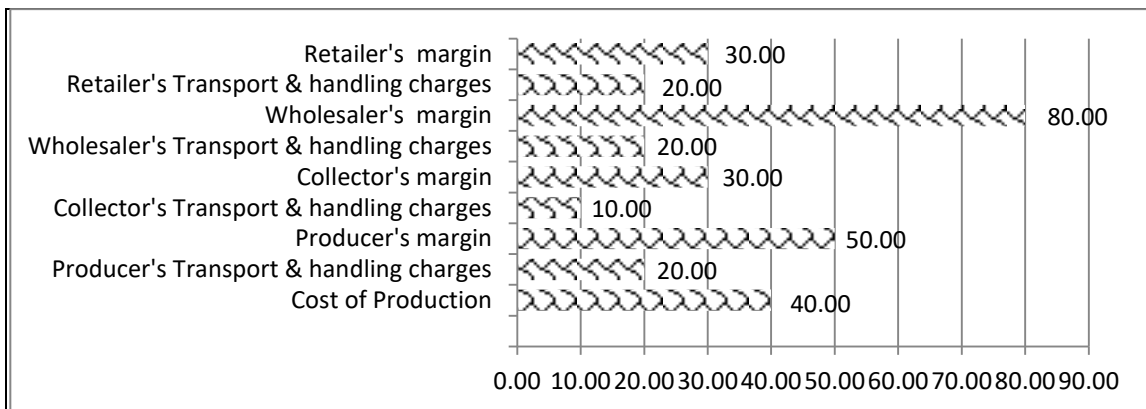

Source: Source: Survey data 2012

Figure 3.22: Value Addition of Chinese Cabbage (Rs/kg)

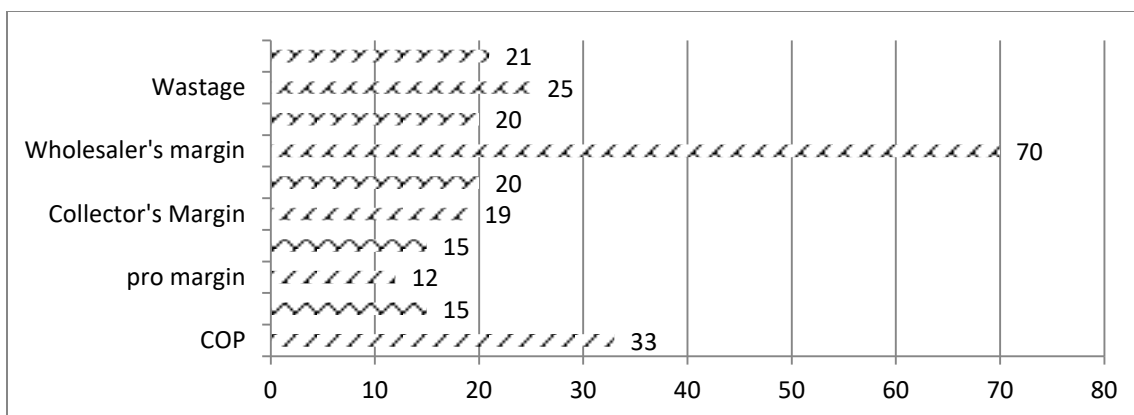

Source: Source: Survey data 2012

Figure 3.23: Value Addition of Pak Choy (Rs/kg)

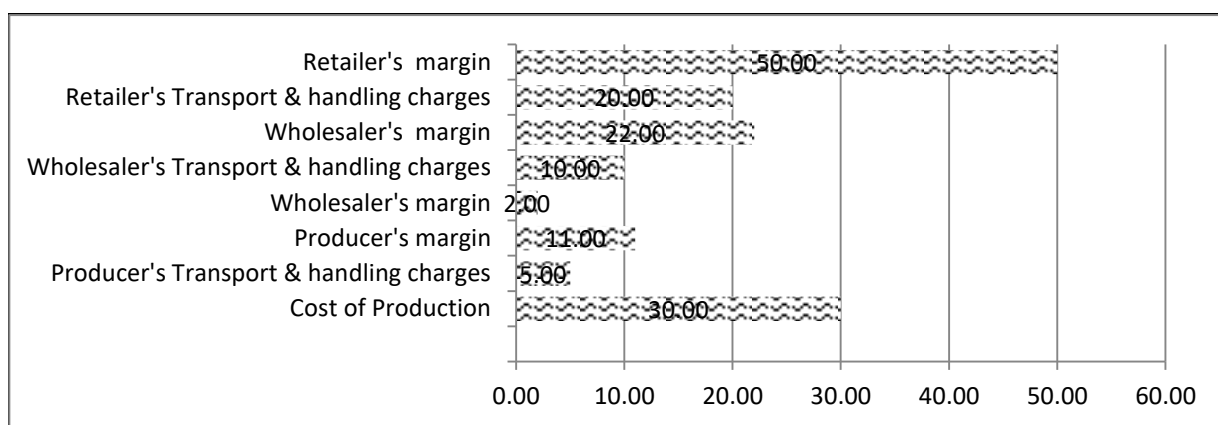

Source: Source: Survey data 2012

Figure 3.24: Value Addition of Cauliflower – Dambulla (Rs/kg)

Table 3.13: Cost of Production of Cauliflower

Item	Cost (Rs.)	% of Total Cost
Land Rent	10,000.00	4.47
Other material	30,740.00	13.74
Seed	6,272.00	2.80
Labour	136,800.00	61.17
Agro chemicals	19,309.00	8.63
Chemical fertilizer	20,530.00	9.18
Total	223,651.00	

Source: Survey data 2012

The data revealed that the cost of produce for a kilo of cauliflower is about Rs.27.95 and the highest expenditure is for labour. The cost of chemical fertilizer is about 9 percent and the cost of agro chemicals is also about 9 percent of the total cost. Fuel usage for irrigation is very high and it is about 55 percent out of the other material cost. Considering the total cost of production the seed cost is about 3 percent. Farmers face difficulties due to increased fuel, chemical and fertilizer costs. They minimize their cost by using family labour.

Table 3.14: Value Chain of High Value Highly Perishable Vegetables

Crop	Cost of Production	producer's transport & handling Charges	producer's margin	Collector's Transport & handling charges	Collector's Margin	Wholesaler's handling charges	Wholesaler's margin	Retailer's Transport & handling charges	Wastage	Retailer's Margin
Tomato	22.9	8.3	6.3	4.2	4.2	0.0	4.2	8.3	8.3	20.8
Cucumber-green	15.9	4.5	6.8	4.5	25.0	9.1	4.5	9.1	9.1	4.5
Pak Choy	13.2	6.0	4.8	6.0	7.6	8.0	28.0	8.0	10.0	8.4
Cauliflower	11.7	6.7	35.0	1.7	1.7	6.7	20.0	6.7		10.0
Broccoli	13.8	6.3	23.8	1.6	1.6	6.3	25.0	6.3		15.6
Iceberg	6.5	5.0	16.0	11.0	21.5	5.0	10.0	5.0	12.5	7.5
Lettuce	6.0	5.0	1.5	2.5	2.5	10.0	27.5	10.0	20.0	15.0
Lettuce red	5.0	5.0	12.5	2.5	5.0	5.0	15.0	5.0	20.0	25.0
Chinese cabbage	13.3	6.7	16.7	3.3	10.0	6.7	26.7	6.7	3.3	6.7
Green Pepper	14.2	3.8	20.8	1.9	17.0	3.8	5.7	4.7	9.4	18.9
Red Pepper	11.4	2.9	35.7	1.4	9.3	2.9	7.9	3.6	7.1	17.9
Yellow Pepper	11.0	2.7	47.9	3.7	7.3	5.5	8.2	3.4	6.8	3.4

Source: Survey data 2012

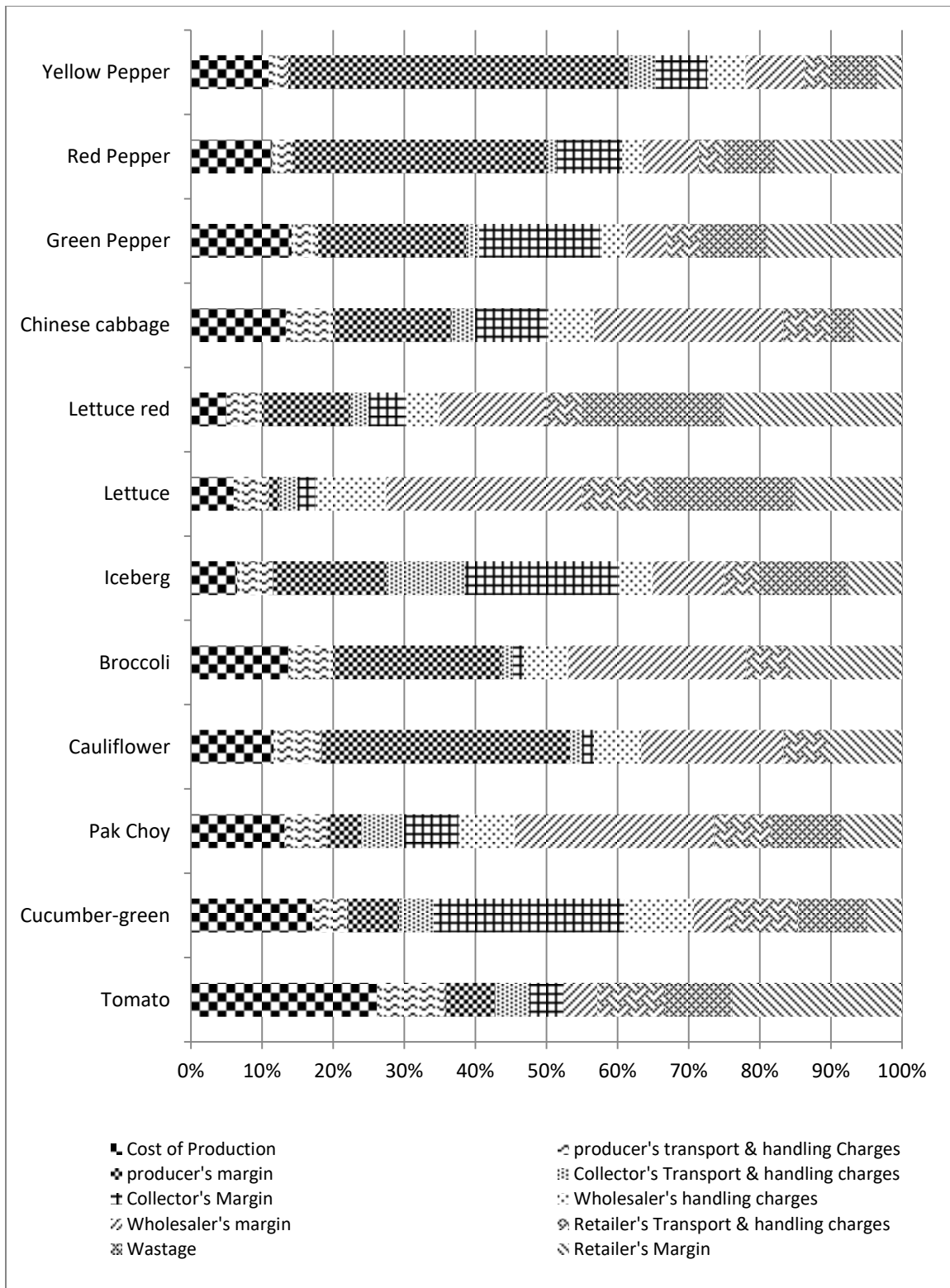

Source: Survey data 2012

Figure 3.25: Value Chain of High Value Highly Perishable Vegetables

Table 3.15: Producer Price Ranges of High Value Vegetables in Uva Paranagama – (Rs/kg) 2012

Month	Cucumber		Bell Pepper Green		Bell Pepper Red		Bell Pepper Yellow		Tomato		Bell Pepper No. 2	
	Min.	Max.	Min.	Max.	Min.	Max.	Min.	Max.	Min.	Max.	Min.	Max.
Jan	50	60	180	260	300	460	300	540	60	70	50	50
Feb	50	80	75	150	230	300	250	375	40	50	20	50
Mar	70	80	50	70	60	230	60	180	40		10	20
Apr	65	70	80	125	90	140	130	230	40	70	20	50
May	70		140	200	130	260	230	330	100	110	30	40
Jun	70	80	165	190	170	275	170	330	100		20	40
Jul	60	80	165	200	120	260	170	300	110	120	20	40
Aug	40		200		350	375	450		80	90	40	

Source: UPEPV & Survey data 2012

Table 3.16: Producer Price Ranges and Gross Margins of High Value Vegetables between Uva Paranagama and Nuwara Eliya–(Rs/kg) July and August–2012

Area	Month	Cucumber		Bell Pepper Green		Bell Pepper Red		Bell Pepper Yellow		Tomato	
		Min.	Max.	Min.	Max.	Min.	Max.	Min.	Max.	Min.	Max.
Uva P	Jul	60	80	165	200	120	260	170	300	110	120
	Aug	40		200		350	375	450		80	90
N E	Jul	150	175	250	300	250	325	350	425	150	200
	Aug	100	140	350	400	500	600	500	600	125	150
Gross Margin (Rs/kg)	Jul	90	95	85	100	130	65	180	125	40	80
	Aug	60	100	150	200	150	225	50	150	45	60
Gross Margin %	Jul	150	119	52	50	108	25	106	42	36	67
	Aug	150		75		43	60	11		56	67

Source: Survey data 2012

High value produce collectors in Uva Paranagama retained very high margins for cucumber, bell pepper and iceberg because these crops were produced mainly in Uva Paranagama area. Table 3.14 showed the producer price ranges and gross margins of high value vegetables between Uva Paranagama and Nuwara Eliya in July and August, 2012. The gross margin varied from 100 -150 percent. The gross profit margin for tomato cultivated under poly tunnels varied from 36 to 67 per cent.

The cost of production of these high value highly perishable crops is less than 20 percent of the retail price. The cost of production of green lettuce and Pak Choy is very low when these crops are cultivated as mixed crops. Almost all the producers use this practice to maximize the profit. Among the high value highly perishable vegetables the most common vegetable is green lettuce. This is available in almost all the retail markets. Though the producer price of green lettuce is very low the retail price is very high at all retail markets. In a day more than 20 percent is wasted due to poor

packaging and handling. The following chart shows the price behaviour at the Pettah retail market. According to the Department of Census & Statistics, the prices of lettuce were above Rs.250.00 per kg during April to June 2011 and the cultivation increased in 2012 resulting in a huge price drop in the same months of 2012.

Table 3.17: Average Cost of Production and Producer's Margin at Farm Level as a Percentage of Retail Price

Crop	Cost of Production	Producer's Transport & Handling Charges	Producer's Profit Margin
Cauliflower – Nuwara Eliya	11.7	6.7	23.3
Broccoli	13.8	6.3	23.8
Chinese cabbage	13.3	6.7	16.7
Green Cucumber	14.0	4.0	6.0
Cauliflower -Dambulla	20.0	3.3	7.3
Bell pepper green	15.0	4.0	21.0
Bell pepper red & yellow	11.4	2.9	35.7
Tomato	27.5	10.0	7.5
Lettuce green	6.0	5.0	1.5
Lettuce Red	5.0	5.0	12.5
Iceberg	6.5	5.0	16.0
Pak Choy	6.8	4.5	15.9

Source: Survey data 2012

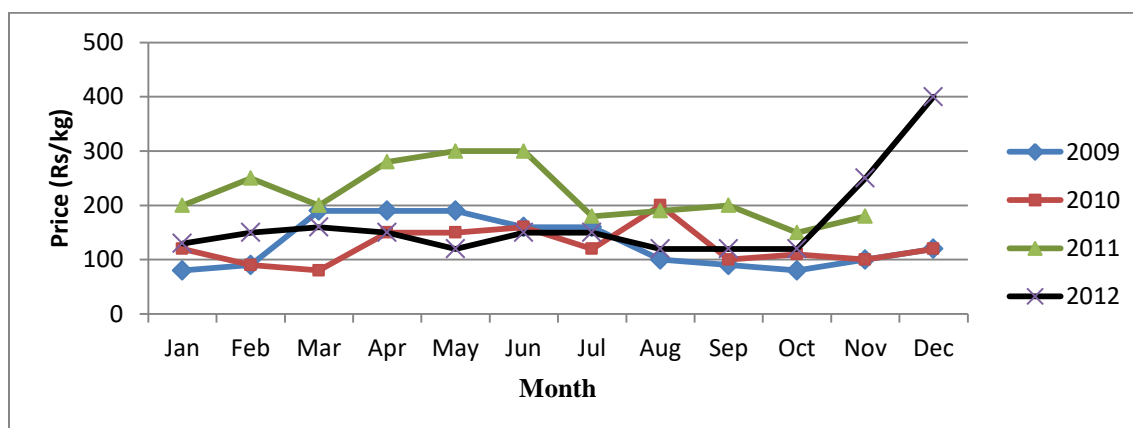

Source: Department of Census and Statistics

Figure 3.26: Retail Prices of Lettuce at Pettah Market

This analysis showed that all stakeholders of this crop sector are benefitted by this agribusiness. Domestic demand from local consumers is increasing very slowly. But the demand from foreigners and high income groups has increased gradually. Producers in the Welimada, Ambagasdova and Bandarawela mentioned that their income had improved considerably after introducing this crop sector and farmers proved that the poverty in the area had reduced considerably.

CHAPTER FOUR

Constraints Faced by Growers, Traders, Exporters and Consumers

The main constraint faced by the growers was to find good quality seeds. Some of the growers mentioned that the seeds available in the market were not germinated. Small scale farmers faced problem of finding good quality seeds in time because medium scale farmers purchased seeds in advance.

Farmers have a lack of awareness about suitable agro chemicals used for these crops. The findings of agricultural research stations had reached very slowly to the farmers due to weak extension service.

Input dealers cited that lack of capital, high prices of fertilizer and agrochemicals and hybrid seed, limited their capacity to stock adequate quantities to meet farmer's needs. In addition lack of technical know-how and coordination among researchers, input suppliers and growers were also a concern.

Quality control for insect contamination and visual appeal must be extraordinarily high as lettuce does not undergo boiling before reaching the consumer's plate.

Post-harvest losses throughout the supply chain could be observed. These highly perishable vegetables were damaged due to negligence in handling. The exporters selected the best quality products and pay only for those products by reducing the value of damaged products. Hence farmers faced the problem of reduced sales income. The wholesalers and retailers retain higher margins to minimize their losses. Finally after cleaning the products retailers keep very high margin and consumers have to pay for the wastages too.

Almost all these products are highly perishable in nature and their shelf life is very limited. Some of the traders use normal transport and quality of the products is deteriorated. Normally exporters request to transport by reefer trucks to maintain the quality. But some of them are engaged in malpractices to minimize the fuel wastage. As a result, the exporters faced problems of deterioration of products.

Prices of those products show that most of these products are not available throughout the year. Almost all the products are available in the period of February to March and June-July-August. To receive the export orders without interruption it is necessary to find new locations.

Small and medium scale producers supply products to the market and they dominate the production. They use proper cultivation practices to maintain the quality to meet

the international standards. But finding the uniform quality for bulk purchases is the problem of exporters. The producers do not bother about the quality of products which are sold at domestic markets. Hence the wholesalers and collectors faced problems of finding quality products to cater to hotels and supermarkets.

Though the supply chain is very clear and short, farmers faced problems of selling excess production when the export orders are very limited because other vegetable collectors do not buy these products.

Due to lack of storage facilities at farm level collecting centres and proper transportation facilities post-harvest losses occur at collector level. Many collectors use trucks without any temperature controlling environment. Prevention of post-harvest losses is a good technique to minimize the retail price at domestic market. Infrastructure facilities at the wholesale markets were not suitable for these products.

Some of the small scale producers, mostly women in the remote areas sell products to the collectors and the price paid for them was much lower than the price received by those collectors from supermarkets and exporters.

There are many exporters engaging in fruits and vegetable exports. They export these high value vegetables too. Compared to other vegetables these vegetables need more attention to retain freshness and to enhance the shelf life. To adopt better marketing practices they had to bear an additional cost.

The local consumers as well as exporters are not sure of the quality they bought. The exporters buy the best quality products available in the market and supermarkets buy the good quality products. The rest of the products are distributed among other retail outlets.

The transporters are engaged in malpractices while transporting highly perishable high value vegetables to minimize their fuel wastage. The quality of these products at the end point is deteriorated when cooler is switched off while transporting.

Poor market information was a constraint faced by the growers and the collector/wholesalers. It was noted that traders do not have systematic ways of accessing information on commodity prices and market opportunities. Information on prices, market supply and demand was not available.

Poor access roads in rural areas were also a constraint faced by the growers. Hence delivery of products to the market was very costly.

CHAPER FIVE

Summary, Conclusion and Suggestions

5.1 Summary and Conclusion

Diverse agro ecological zones of Sri Lanka are well suited for cultivation of different types of vegetables. To reduce rural poverty in the Uva province through increasing farm income the governments has been searching for new ways. Accordingly this new crop sector, high value highly perishable vegetables, was introduced with new technology. This helped avoid the major problems faced by the farmers in the areas due to lack of enough water for cultivation. Sri Lanka Fruit & Vegetable Producers, Processors and Exporters Association intervened in this sector with the support of the Sri Lanka Export Development Board (SLEDB). This intervention was successful and the objectives were achieved with the help of officers in the agricultural sector. Then the farmers and officers in Bandarawela selected many new crops to grow in these areas. The most common crops were bell pepper, iceberg, Pak Choy, lettuce and many varieties of herbs. Except for those cauliflower and broccoli were cultivated in Nuwara Eliya. These crops were called high value crops and growers did mixed cropping to maximize the farm income.

Farmers cultivated bell pepper and tomato under poly tunnels and iceberg, lettuce, Pak Choy, basil, Chinese cabbage etc. in the open field. This crop sector was popularized among farmers very slowly in the earlier stage because farmers were reluctant to risk the cultivation due to lack of awareness on cultivation and market demand. About 50 farmers are engaged in this crop sector in 2009 and this number increased by 85 percent in 2010 and 32 percent further in 2011 in Bandarawela area. The experienced farmers expanded their cropping extent by building new poly tunnels and giving up earlier cultivated crops. According to the farmers, this innovation uplifted their livelihoods. Earlier these crops were cultivated targeting the export market. Later on the demand increased from hotels and supermarkets due to the demand from local consumers in the urban areas.

In Uva Paranagama area 100 poly tunnels were distributed among poor farmers and this new technology was captured by about 400-500 young farmers and they cultivate bell pepper and tomato under poly tunnels. According to the traders, there are about 800 poly tunnels of 1000sq feet in the area. Youth entered this trade and they provide services to newcomers and construct low cost poly tunnels. The cost of construction of a 1000sq feet poly tunnel is about Rs.110,000.

Farmers in Sapugolla, Nakadiya, Ambagasdowa, Pallewela, Unapana and Udukumbura areas in Uva Paranagama cultivated these high value vegetables. Their farm income

increased with the higher demand from wholesalers and tourist hoteliers located in various towns in the country. But the farmers in Unapana faced many hardships in transporting their produce to the market due to lack of motorable roads.

Lettuce is generally a disease and pest free crop. But cutworms and slugs are the most bothersome pests in the field. The major threat was lettuce rot and farmers applied agro chemicals to protect the crop. Farmers are aware of the benefit of crop rotation and some of the farmers have experienced that this it is an effective method to prevent fungal and bacterial diseases.

Various types of lettuce were cultivated in Nuwara Eliya and the quantity was higher than that in Uva Paranagama area because farmers hold the view that the climate in Uva Paranagama area is good for iceberg and Pak Choy but not for loose leaf lettuce. Nuwara Eliya farmers cultivated romaine lettuce as inter cropping with carrot, leeks, beetroot and cabbage. Other high value lettuce varieties are cultivated by a very few farmers in Meepilimana area.

The farmers who have gained experience of cultivation entered product marketing and also they started to produce seeds by themselves. The average farm size in Nuwara Eliya and Bandarawela was about ½ ha -1ha with the average lettuce field size is about ¼ ha. The majority of growers plant green leaf lettuce along with other varieties throughout the year to gain an extra income by way of extra effort to meet the fluctuating demand. Most of the farmers cultivate three to four crops of iceberg and green lettuce per year in staggered plantings because farmers are aware of the daily demand of each crop. Many of the farmers in Uva Paranagama grow iceberg lettuce followed by other high value crops such as Chinese cabbage, celery or red radish. These farmers grow Pak Choy along with other crops such as iceberg, Chinese cabbage, basil and cucumber.

According to the FAO statistics the leading producer of lettuce and chicory was China followed by the USA. These two countries produce about 70 per cent of the world production. As India also produces large quantities some of the leading exporters used to purchase these products to fulfill their export orders.

To enjoy the authentic flavor of these vegetables they should be kept fresh. The leaves of loose leaf varieties wilt quickly. Tourist hotels mix crisp, crunchy varieties with soft buttery smooth types to offer a colourful and delightful salad bowl.

Well experienced farmers as well as young farmers gained higher prices by providing good quality products to the exporters. Cauliflower and broccoli were widely available in Nuwara Eliya. Cauliflower cultivation has spread in Kandy, Matale and Puttalam districts too while broccoli cultivation is still limited to Nuwara Eliya area. As a result, the price

of cauliflower has dropped considerably. Hence Nuwara Eliya farmers reduce the cultivation of cauliflower and increased the cultivation of broccoli.

Cauliflower and broccoli reached the market in May and the peak harvesting season lies in July to August. During that period the producer prices and wholesale prices had dropped below Rs.45.00 per kg in Dambulla wholesale market. The lowest prices were reported in third week of July and the gross margin between producer price and wholesale price was Rs.2.50 per kg. Farmers harvest cauliflower early morning and pack the produce in cardboard boxes very carefully. A box can contain about 25kg of cauliflower. The farmers are highly concerned about the quality of cauliflower because the damaged curds had a very low value. In Sri Lanka a very limited supply of these crops is available throughout the year and larger supply can be seen especially in February - March and July - September. Most of the Indian cultivars of cauliflower are marketed in September to January. A number of improved cultivars were released by various research organizations in India on the basis of their superior performance. Therefore to capture the export market our country has to plan the cultivation properly in accordance with the above mentioned seasons.

Almost all the farmers harvest these high value highly perishable vegetables in the early morning when it is fresh and cool. Bell peppers are harvested every week and most of the products are sold as mature green peppers. Some of the farmers used to harvest red or yellow bell peppers, which are actually the mature stage of green bell peppers that have been allowed to ripen on the vine, because their prices are very high compared to that of green peppers. The cost of production of red or yellow bell peppers are higher than that of green bell peppers because losses at the field level are higher and yields are lower than those harvested at the green stage.

In 2011 the farmers moved away from the UPEPV Company. Youth entered the business and they are engaged in this crop sector as entrepreneurs. They provide technical knowhow as well as services for building poly tunnels and repairs, supplying agro chemicals, seeds etc. to farmers. Hence the small scale farmers linked to this centre by acquiring the trust. Therefore these youth have the confidence to expand the business. For purchasing only bell pepper they paid Rs.2 million during the first half of the year 2012.

The demand from local consumers as well as exporters has changed gradually during the last decade. This change provided more opportunities to local vegetable farmers to produce various types of vegetables and thereby increasing their farm income. The demand as well as the quality of vegetables varies according to the market places. To supply vegetables to exporters, tourist hotels, supermarkets, restaurants and other food retail stalls farmers plan the cultivation. Their farming practices differ according to the experience and the level of the risk associated with marketing of these products. Well experienced farmers did multicropping and relay cropping while others did

monocropping. They were practicing multicropping in a very small scale and at present they have gained experience of earning a higher income.

Considering the cultivation pattern of farmers it was reported that the farmers who are engaged in bell pepper cultivation grow other high value crops such as tomato, iceberg and cucumber.

The leading purchasing centre in the Uva Paranagama area was Uva Paranagama Export Production Village (UPEPV) purchasing centre. There were 100 high value crop farmers in the area linked in 2010 and the number increased to 125 in 2011. As the growers found new ways to sell their products the number of farmers linked to the centre had declined to a 116 in 2012. The farmers engaged in the supply chain through UPEPV Company found new supply chains to sell their products. Farmers who cultivated bell pepper, tomato and cucumber are still engaged in this supply chain. Out of 270 farmers 62 per cent cultivated bell pepper, 12 per cent grew green cucumber, 11 per cent cultivated tomato and 14 per cent grew ice berg, celery, Chinese cabbage and Pak Choy. During January to July 2012, 80 bell pepper farmers are linked in bell pepper supply chain and these 80 farmers comprised 58 green pepper farmers, 56 red pepper farmers and 39 yellow pepper farmers. Growing of bell pepper variety is based on the prices received during the previous season. Well experienced farmers cultivated both red and yellow bell pepper varieties and the number was 13 out of 80 farmers. Altogether 116 farmers were identified and they cultivate other high value vegetables also. According to the views of farmers and traders in the area the total number of farmers were around 400.

Considering the years of 2010, 2011 and 2012, cultivation of high value crops, about 190 farmers directly linked to the UPEPV purchasing centre and also to other collectors in the village for selling their products. The total annual sales by each farmer to the UPEPV purchasing centre varied from 10kg to 5000kg. They provide technical knowhow as well as services for building poly tunnels and repairs, supplying agro chemicals, seeds etc. to farmers.

Though the farmers linked to the UPEPV purchasing centre have shown a slight decline, the number of farmers entering this crop sector has increased gradually. Well experienced farmers have entered the trading activities too. Another vital feature was that due to various reasons farmers selected crops for growing. The main reasons envisaged were their experience, farm income, convenience in growing and short growing period. Almost all the farmers grow about 3- 4 crops in the same land to maximize their income. The cropping pattern varies on the market demand and relative prices.

The marketing channels were very short and these helped minimize wastages and improve the quality of products. However the growers had to sell their products to the

village collector or directly to the collector in the nearest town. The collectors sold products in accordance with the orders placed by the regional managers of supermarkets and the cooperative or the collecting centre initiated by the Export Development Board. Exporters are directly linked with the cooperative or export production village outlet to purchase the required quantity on a regular and pre-arranged basis. These traders maintained reliability with the exporters and other wholesalers as well as the growers. These high value perishable crops have the potential to expand incomes along the whole supply chain from the farmer to consumer, because these chain actors enjoy higher prices and better profit margins.

The rejections were about 2-3 per cent of the sales value at the earliest stage. Most of the farmers have about 10 years of experience for cultivation and selling of some of these commodities. Farmers and collectors faced many problems with higher rates of rejection by leading exporters during the latter part of 2010.

Small farmers have benefited in Uva Paranagama area and received Rs.mn.6.9 in 2010 and Rs.mn.5.5 in 2011. Up to July 2012 farmers in the area received about Rs.mn. 3 by selling only three items through UPEPV. The other farmers in the area sold their products to village collectors and according to them, their income also increased considerably.

The demand for these crops was very limited. Hence collectors always place orders according to the demand. The collectors in the producing areas are linked with the farmers as well as exporters and local traders. Daily demand from each collector declined as many large scale farmers entered the trade due to high profit margins prevailed in this crop sector. Hence the daily demand from each collector was around 25kg. As the UPEPV curtailed buying leafy vegetables, all high value vegetable collectors in the sector are fully engaged in leafy vegetable business.

There were about 6 wholesalers in the Nuwara Eliya Dedicated Economic Centre and among them only three lead the market. Some of the high value vegetable collectors distributed those vegetables to Colombo tourist hotels and they were very concerned about the product quality and appearance. Though almost all these crops are available throughout the year the seasonality could be observed. The supply of cauliflower and broccoli increases in February, March and April and also in July and August. The demand increases in April and December. The wholesale prices at Nuwara Eliya increased in 2011 and those prices declined in 2012 with an increased supply.

This review showed that this crop sector has gradually improved and there is a possibility to improve this sector as young people have entered this agribusiness. Earlier the distribution systems of vegetables from producer to consumer caused very heavy post-harvest losses due to lack of proper transport. After introducing tax and other incentives for agricultural sector, mainly for duty free imports of capital goods, the

distribution system improved rapidly by reducing wastages. The present distribution system from producer to consumer of these vegetables facilitated the consumers to purchase good quality produce from green vegetable stalls as well as from supermarkets. Consumers have become increasingly conscious of good quality at the retail end of the supply chain. Therefore transporters of these products use their experiences to improve the product quality and minimize the losses during transportation.

As the opportunities exist for the cultivation and export of high value vegetables the rural farmers enjoy higher prices and better profit margins. Though the domestic market has been improving very slowly this crop sector has the potential to expand incomes along the whole supply chain from farmer to consumer. Awareness programmes should be conducted to increase the domestic market demand because younger generation should be informed of the health benefits of consuming more fresh vegetables as salads. This will help increase the nutritional value of daily diets and improve the health of consumers. There is a market potential for various types of salad lettuce, bell pepper, cauliflower, broccoli and cucumber.

The collectors in the producing areas normally retained a 25 percent gross margin for their investment on this high value highly perishable crop sector. This margin varied from 15 – 25 percent earlier but has declined with higher competition among collectors. This gross margin varies according to the supply and demand and also the risk factor. Sometimes wholesalers in urban areas rejected 10 – 25 percent of the total supplies and payments were made only for the accepted good quality quantities. To minimize the damages the supply chain was kept very short and supplies were distributed to the final destination as soon as possible. As the supply chain was very short the chain actors got higher profit margins. The producers are also satisfied with their earnings because they are able to cover up their cost and minimize the risk.

Bell pepper producers gained about 40 to 64 percent of the consumer rupee and in the case of yellow and red bell pepper it was over 50 percent. Their profit margin varied from 21 to 36 percent out of the retail price. In the service sector retailers retained the highest margin which was about 25 percent of the retail price. The collectors and wholesalers received about 8 to 13 percent margins of the retail price. The risk for selling at collectors' and the wholesalers' levels is very low compared to that at the retail level. At the retail level products were moving very slowly due to very limited demand from consumers. The highest margin (32 percent) of retail price of green cucumber was retained by the collectors followed by retailers (22 percent). The transport and handling charges at wholesaler level varied from 3 – 4 percent and that of retailers varied from 4 – 5 percent. Producer's margin for red lettuce, Pak Choy and iceberg varied from 12.5 to 16 percent of the retail price while that of green lettuce was about 2 percent. The producers of cauliflower and broccoli reserved a 35 and 24 percent margin of the retail price respectively while it was about 16 percent for Chinese cabbage. The wholesalers

reserved about 20 to 27 percent margins out of the retail prices of these crops. Both retailers of cauliflower and Chinese cabbage retained about 10 percent of the retail price while broccoli retailers retained about 16 percent of the retail price.

For minimizing the handling and transport cost of plastic crates producers used corrugated cardboard boxes to pack cauliflower and broccoli. Transporters and collectors who delivered produce to hotels, restaurants, supermarkets and other retail stalls directly, used plastic crates to minimize damages. Lettuce supplied to the local market was not packed in a proper way. They were wrapped in poly sacks and their damages were very high compared to other commodities.

In Dambulla, cauliflower farmers received a very low margin compared to that of Nuwara Eliya farmers. The demand for cauliflower supplied from Dambulla was very high in the market due to consumer affordability. In addition, cauliflower was supplied to the market from Kalpitiya area too. Prices of these cauliflowers were also very low compared to that of Nuwara Eliya product.

The highest producer's share was reported for yellow bell pepper followed by red bell pepper. Considering the leafy vegetables the highest share was showed for Chinese cabbage followed by iceberg. Broccoli and cauliflower farmers received 44 and 41 percent from Nuwara Eliya area while the share of cauliflower farmers in Dambulla was 31 percent out of retail price. The wholesalers in Nuwara Eliya area retained a higher margin because many of them distribute these products among outstation retailers. Due to the highly perishable nature the collectors cum wholesalers who distributed these products among retail outlets in distant urban cities, limit loading and unloading functions to maintain the quality. The leafy vegetable retailers retained higher margins to minimize their losses due to wilting because of the hot climate in urban cities in Colombo as well as Galle, Matara and Hambantota where the demand is higher, the outer leaves rapidly turn pale. Retailers of bell pepper retain higher margins to avert the losses because the daily demand was very low and the product remained with them about three to four days.

High value produce collectors in Uva Paranagama retained very high margins for cucumber, bell pepper and iceberg because these products are produced mainly in Uva Paranagama area. The gross margin varied from 100 -150 percent. The gross profit margin for tomato cultivated under poly tunnels varied from 36 to 67 percent.

The cost of production of these high value highly perishable crops is less than 20 percent of the retail price. The cost of production of green lettuce and Pak Choy is very low because these crops are cultivated as mixed crops. Almost all the producers are engaged in this practice to maximize the profit.

Among the high value highly perishable vegetables the most common vegetable was green lettuce. This was available in almost all the retail markets. Though the producer price of green lettuce was very low the retail price was very high at all retail markets because within a day more than 20 percent was wasted due to poor packaging and handling.

The gross margin of cauliflower and broccoli producer is about 42 and 30 percent of the retail price. Chinese cabbage, iceberg and Pak Choy farmers gained 20 – 24 percent of retail price. Producers use their farming experience to minimize the cost of production. They use cardboard boxes and plastic crates for packaging and use transport with appropriate facilities which can reduce damages. Some of the producers sell their produce at the farm to minimize the cost of transport and save their time for other crop management. Gross margin for bell pepper varies from 25 to 39 percent of the retail price. The well experienced farmers maintain the crop properly to obtain higher yields and produce good quality bell pepper. Their income is much higher than that of other small scale producers.

The main constraint faced by the growers was to find good quality seeds. Some of the growers mentioned that the seeds available in the market were not germinated. Small scale farmers faced the problem of finding good quality seeds in time because medium scale farmers purchased seeds in advance.

Farmers have a lack of awareness about suitable agro chemicals used for these crops. The findings of agricultural research stations had reached very slowly to the farmers due to weak extension service.

Input dealers faced lack of capital, high prices of fertilizer and agrochemicals and hybrid seed limited their capacity to stock adequate quantities to meet farmer's needs. In addition, lack of technical know-how and coordination among researchers, input suppliers and growers was also a concern.

Post-harvest losses throughout the supply chain could be observed. These highly perishable vegetables were damaged due to negligence of handling. The exporters selected the best quality products and pays only for those products by reducing the value of damaged products. Hence farmers faced the problem of receiving low sales income. The wholesalers and retailers retained higher margins to minimize their losses. Finally after cleaning the products retailers retained very high margin and consumers have to pay for the wastages too.

5.2 Suggestions

Lack of technical know-how among input dealers and farmers could be addressed by training input dealers creating a platform for regular dialogue among growers, input dealers and agrochemical companies.

The small scale farmers mentioned that to improve the quality they apply agrochemicals. But due to lack of knowledge about agrochemicals and poor agronomic practices they overuse agrochemicals without considering their health implications. In order to address this constant training and capacity building of farmers on production and pest and disease management is very important. The growers should be supported in adopting integrated pest management practices. This can be achieved by fostering partnerships with private sector service providers at agricultural exhibitions.

It was noted that traders are linked to the producers and exporters. But they do not have systematic ways of accessing information on prices, market demand and supply, target markets etc. There is a need to establish market information points at leading economic centres for information briefs on prices, supply and demand. Make information available through available ICT technology such as mobile phones, electronic media etc. and also through print media.

In order to reduce the post-harvest losses it is very vital to improve the trading environment with appropriate modern market facilities at the wholesale and retail markets.

Further, enhancing the domestic demand can be done by introducing the products to the younger generation through agricultural exhibitions. Various dishes can be introduced and made available to taste at these places. Special attention should be paid to quality control in terms of preventing insect attacks. Visual appeal must be extraordinarily high because lettuce is consumed fresh without being cooked.

Almost all the producers were not aware of the culinary methods of these vegetables and their nutritional values. Through trade shows awareness programmes should be conducted with the participation of the private sector.

Rural agricultural roads should be maintained properly to facilitate distribution of agricultural products among various markets without delay.

REFERENCES

- Agricultural Cooperative Society Ltd. Nuwara Eliya, Producer Prices, Wholesale Prices and Supply data
- An Integrated Regional Value Chains Approach to Agricultural Development in Africa – Economic Report on Africa (2009), Developing African Agriculture through regional value chains.
- Asian Vegetable Research and Development Centre (AVRDC)
- Burden D. “Bell and Chili Peppers Profile” Content specialist, AgMRC, Iowa State University, djburden@iastate.edu. Revised By Huntrods, D. AgMRC, Iowa State University. Nov.2011
- Balapatabendi, C, (May 2010), Agri-foods Sector Profile₁ - Colombo, Sri Lanka.
- Carlos A da Silva et al. Guidelines for rapid appraisals of agri food chain performance in developing countries- Agricultural Management, Marketing and Finance occational paper – FAO Rome 2007.
- Cauliflower- Wikipedia.the free encyclopedia
- Commodities and Trade Division’ FAO Commodities and Trade Technical Paper 3. Food and Agriculture Organization, Rome.
- Dedicated Economic Centre- Nuwara Eliya, Daily Wholesale Prices
- Dedicated Economic Centre- Dambulla, Daily Wholesale Prices
- Dedicated Economic Centre- Narahenpita, Daily Wholesale and retail Prices
- Dept. of Census & Statistics, Income and expenditure Survey - various publications - Retail Prices
- Department of Agriculture
- Dimensions of Agricultural Value Chains, Ag Education Consulting LLC.
- Dolan, C., Humphrey, J., Harris-Pascal, C., (1999), Horticulture commodity chains: the impact of the UK market on the African fresh vegetable industry. IDS Working Paper 96.

Export Development Board –Lists of Exporters, Processors etc

Food and Agriculture Organization of the United Nations,(2007), Approaches to Linking Producers to Markets, Agricultural Management, Marketing and Finance Occasional Paper No.13. Rome: FAO.

FAO Statistics Division 2011, Top ten lettuce and chicory producing Countries – 2010

FAO statistics database- Website: <http://www.fao.org/corp/statistics/en/>

Gereffi, G., J. Humphrey, and T. Sturgeon, (2003), The Governance of Global Value Chains. Review of International Political Economy, 12(1): 78-104. World Bank, 1987

Hallam, D., P. Liu, G. Lavers, P. Pilkauskas, G. Rapsomanikis and J. Claro (2004), 'The market for Non-Traditional Agricultural Exports: Raw materials, Tropical and Horticultural Products Service

IFAD, (2008), Near East and North Africa Division, Programme Management Department, 'The role of high value crops in rural poverty reduction in the Near East and North Africa

Kaplinsky, R., (2000), Spreading the gains from globalisation: what can be learned from value chain analysis. IDS Working Paper 110.

Lettuce- Wikipedia.the free encyclopedia

Marketing Food Policy and Agribusiness Division/HARTI, Retail Prices

Moving toward competitiveness: A value chain Approach. FIAS 2007.

Porter, M.E., (1985), "Competitive Advantage: Creating and Sustaining Superior Performance" The Free Press, New York.

Ranaweera, N.F.C. and de Silva, G.A.C. "Dynamics of vegetable production, distribution and consumption in Asia" (2000), Editor-Mubarak Ali, Asian Vegetable Research and Development Center, AVRDC publication, page no: 349-378

USDA Nutrient data Bas

<http://www.agmrc.org/commodities-products/vegetables/lettuce-profile.cfm> By Hayley Boriss and Henrich Brunke, Agricultural Issues Center, University of California.

Revised July 2011 by Malinda Geisler, content specialist, AgMRC, Iowa State University.

<http://www.agmrc.org/commodities-products/vegetables/cauliflower-profile.cfm> ayley Boriss, Henrich Brunke and Marcia Kreith, Agricultural Issues Center, University of California. Updated June 2011 by Diane Huntrods, AgMRC, Iowa State University

[http://www.agmrc.org/commodities-products/vegetables/Bell and Chili Peppers Profile](http://www.agmrc.org/commodities-products/vegetables/Bell_and_Chili_Peppers_Profile)By Dan Burden, content specialist, AgMRC, Iowa State University, djburden@iastate.edu. Revised November 2011 by Diane Huntrods, AgMRC, Iowa State University.

USDA Nutrient Database, Nutritional Value per 100g of Butterhead Lettuce

USDA National Nutrient Database for Standard Reference; Nutrition Information for Iceberg Lettuce

Uva Paranagama Export Production Village Producer Prices, Wholesale Prices and Supply data

Value chain – Wikipedia.the free encyclopedia

Value links Manual, The Methodology of Value Chain Promotion – GTZ Eschborn, (2007). Value Links Module 1

World Health Organization. Diet, nutrition, and the prevalence of chronic diseases. Geneva, Switzerland: World Health Organization; (2003). Contract No.: WHO Technical Report Series No. 916.

www.dailymirror.lk

www.motherearthnews.com

www.Sri Lanka Fruit & Vegetable Producers, Processors and Exporters Association.lk, International Foodstuff Company (Pvt) Ltd (IFCO)

World Bank (1987), World Development Report (1987). Washington, DC: World Bank.

Annex 1

Table 1: Daily Supply Ranges to Leading Collectors (Kg/day)

Year & Month	Bell Pepper (Green)		Bell Pepper (Red)		Bell Pepper (Yellow)		Tomato in poly tunnels	
	Min	Max	Min	Max	Min	Max	Min	Max
2011								
Jan	10	26	3	26	1	20	50	152
Feb	9	24	9	25	10	25	45	111
Mar	8	18	3	22	5	15	6	101
Apr	9	23	1	20	2	10	5	138
May	2	20	1	21	1	15	6	101
Jun	10	15	7	16	2	15	3	75
Jul	10	20	3	15	2	7	15	78
Aug	10	20	6	20	1	10	14	99
Sep	10	39	3	25	6	40	27	102
Oct	10	20	10	25	1	20	25	100
Nov	2	20	1	20	1	15	26	77
Dec	10	15	10	25	4	15	26	101
2012								
Jan	10	25	10	26	3	21	46	205
Feb	5	20	10	24	1	20	44	103
Mar	5	15	10	30	5	15	22	77
Apr	10	20	7	20	6	6	13	102
May	1	20	1	15	2	8	29	77
Jun	10	10	10	10	5	10	41	100
Jul	10	15	10	15	5	11	25	100
Aug	10	20	10	20	5	11	13	76
Sep	1	20	1	15	2	8	29	77
Oct							41	75
Nov	9.8	15	9.6	15	5	11	25.3	100

Source: DEC Nuwara Eliya and AgCo

Cont.d'

Table 1: Daily Supply Ranges to Leading Collectors (Kg/day)

Year & Month	Broccoli		Cauliflower		Chinese Cabbage		Ice berg	
	Min	Max	Min	Max	Min	Max	Min	Max
2011								
Jan	2	70			20	64	8	56
Feb	6	96	25	132	16	63	6	73
Mar	11	100	13	178	2	60	6	53
Apr	8	56			15	54		
May	11	70			11	54		
Jun	23	73			4	53		
Jul	7	56			15	55	6	53
Aug	1	70	2	26	10	61	15	48
Sep	18	95	2	25	15	76	11	76
Oct	9	64	13	48	16	56	8	51
Nov	16	56	15	49	15	51	7	45
Dec	29	70	10	25	15	52	9	55
2012								
Jan	12	102	2	97	10	71	14	76
Feb	3	73	2	194	15	66	9	62
Mar	27	113	10	101	7	50	4	52
Apr	22	69	6	22	11	45	9	45
May	4	67	2	26	10	45	10	45
Jun	7	98	8	24	16	51	10	51
Jul	11	73	10	25	16	51	5	51
Aug	11	69	8	22	15	49	5	47
Sep	13	67	2	26	10	45	10	45
Oct	4	98	8	24	16	41	10	46
Nov	10	73	10	25	16	51	4	51

Source: DEC Nuwara Eliya and AgCo

Cont.d'.....

Table 1: Daily Supply Ranges to Leading Collectors (Kg/day)

Month	Lettuce - Green		Lettuce - Red		Lettuce-Butter-red		Butter Head Lettuce	
	Min	Max	Min	Max	Min	Max	Min	Max
2011								
Jan	41	277			3	3	8	45
Feb	87	249			6	17	3	36
Mar	74	229			2	8	5	38
Apr	55	186	2	3	2	10	10	30
May	68	176	3	4	1	10	8	28
Jun	76	174	1	6	2	7	7	26
Jul	55	227	1	9	1	11	6	41
Aug	11	275	2	2	1	1	7	39
Sep	71	310			1	6	5	42
Oct	84	225	1	6	1	10	9	37
Nov	93	246	1	5	2	11	8	36
Dec	102	260	1	3	0	8	1	30
2012								
Jan	82	452			2	2	7	50
Feb	92	357			1	6	8	39
Mar	90	300					6	32
Apr	78	210			1	6	6	28
May	93	226			2	7	5	27
Jun	78	237			1	5	7	26
Jul	107	180					3	26
Aug	78	210			1	6	3	26
Sep	93	226			2	7	5	27
Oct	78	237			1	5	7	26
Nov	107	180					3	26

Source: DEC Nuwara Eliya and AgCo

Cont.d'

Table 1: Daily Supply Ranges to Leading Collectors (Kg/day)

Month	Pak Choy		Zucchini Yellow		Zucchini Green		Cucumber Green	
	Min	Max	Min	Max	Min	Max	Min	Max
2011								
Jan	8	38	2	20	14	45		
Feb	7	37	3	21	11	51		
Mar	2	39	1	21	6	43		
Apr	11	36	3	43	10	45		
May	9	32	1	21	8	36		
Jun	10	28	2	22	9	36		
Jul	9	30	2	18	9	36		
Aug	9	30	1	20	10	34		
Sep	8	41	1	24	9	67		
Oct	9	26	2	16	9	35		
Nov	8	24	2	15	10	36		
Dec	3	29	2	15	5	27		
2012								
Jan	2	54	1	30	10	61		
Feb	8	30	3	21	11	38		
Mar	7	38	1	20	8	35		
Apr	6	25	2	15	4	25		
May	5	28	2	20	10	50		
Jun	10	31	5	20	7	35		
Jul	10	31	4	20	13	35		
Aug	8	31	2	20	4	35		
Sep	5	28	2	20	10	50		
Oct	10	31	5	20	7	35		
Nov	10	31	4	20	13	35		

Source: DEC Nuwara Eliya and AgCo

Table 2: Daily Requirement and Supply of High Value Vegetables 2011 & 2012 (kg)

Year & Month	Bell Pepper (Green)		Bell Pepper (Red)		Bell Pepper (Yellow)		Tomato in Poly Tunnels	
	Req.	Sup.	Req.	Sup.	Req.	Sup.	Req.	Sup.
2011								
Jan	14	13	13	14	9	9	80	78
Feb	14	13	15	15	13	12	73	71
Mar	14	14	15	15	12	11	63	62
Apr	12	12	10	10	7	7	68	67
May	12	12	12	12	7	7	62	61
Jun	14	13	14	14	9	9	41	39
Jul	14	14	10	10	4	4	47	45
Aug	16	15	12	12	6	6	49	47
Sep	17	17	15	16	17	17	103	101
Oct	12	12	13	13	10	10	53	52
Nov	14	13	14	15	11	11	54	53
Dec	13	13	15	15	9	9	55	54
2012								
Jan								
Feb	15	15	16	16	9	9	76	75
Mar	15	15	16	17	11	12	68	67
Apr	11	11	18	18	10	10	55	54
May	14	14	12	13	6	6	55	54
Jun	11	11	7	7	6	6	54	51
Jul	10	10	10	10	8	7	53	54
Aug	11	11	11	11	9	9	51	50
Sep	13	13	13	13	8	8	53	52
Oct	11	11	7	7	6	6	54	51
Nov							51	52

Source: DEC Nuwara Eliya and AgCo

Cont.d'

Table 2: Daily Requirement and Supply of High Value Vegetables 2011 & 2012 (kg)

Year & Month	Broccoli		Cauliflower		Chinese Cabbage		Ice berg	
	Req.	Sup.	Req.	Sup.	Req.	Sup.	Req.	Sup.
2011								
Jan	31	29			36	35	32	28
Feb	54	52	78	75	36	35	34	32
Mar	43	40	70	67	30	29	27	26
Apr	30	29			35	34		
May	37	35			31	30		
Jun	40	38			29	28	6	
Jul	28	27			32	31	28	25
Aug	33	32	15	14	33	32	29	26
Sep	53	50	15	14	38	37	39	35
Oct	38	36	24	24	33	32	25	24
Nov	40	38	25	24	28	28	21	21
Dec	46	44	16	16	29	29	25	24
2012								
Jan					29	29	33	32
Feb	54	52	42	41	34	33	29	28
Mar	32	31	73	71	26	25	24	24
Apr	47	47	36	37	23	22	21	20
May	44	42	16	15	25	24	24	23
Jun	35	34	14	14	32	32	28	27
Jul	43	42	15	15	29	29	29	28
Aug	44	43	19	16	26	26	23	22
Sep	40	39	18	16	24	24	23	23
Oct	38	36	15	15	30	30	26	26
Nov	39	38	15	14	30	30	30	29

Source: DEC Nuwara Eliya and AgCo

Cont.d'

Table 2: Daily requirement and Supply of High Value Vegetables 2011 & 2012 (kg)

Month	Lettuce - Green		Lettuce - Red		Lettuce-Butter-red		Butter Head Lettuce	
	Req.	Sup.	Req.	Sup.	Req.	Sup.	Req.	Sup.
2011								
Jan	169	142	26	22			5	3
Feb	169	145	27	22			13	11
Mar	151	134	26	21			7	6
Apr	127	110	28	24	3	2	7	6
May	123	105	23	19	3	3	5	4
Jun	124	110	22	19	4	3	5	4
Jul	147	123	21	17	4	3	7	6
Aug	163	139	22	18	4	2	1	1
Sep	205	181	26	22			4	3
Oct	140	127	18	16	4	4	5	4
Nov	152	139	18	16	3	3	6	5
Dec	162	147	17	14	2	2	4	3
2012								
Jan	217	196	18	16			2	2
Feb	207	190	19	17			4	3
Mar	186	169	18	16				
Apr	151	139	17	15			4	4
May	165	152	17	15			4	4
Jun	181	169	21	20			4	3
Jul	156	140	21	19				
Aug	155	142	19	17			4	4
Sep	163	150	16	15			4	4
Oct	182	170	21	19			4	3
Nov	154	139	22	20				

Source: DEC Nuwara Eliya and AgCo

Cont.d'

Table 2: Daily Requirement and Supply of High Value Vegetables 2011 & 2012 (kg)

Month	Pak Choy		Zucchini Yellow		Zucchini Green		Red Cabbage	
	Req.	Sup.	Req.	Sup.	Req.	Sup.	Req.	Sup.
2011								
Jan	20	28	11	10	26	25	17	24
Feb	19	32	10	10	26	25	17	23
Mar	20	26	8	8	26	25	12	23
Apr	18		12	12	28	27	4	20
May	16		8	8	25	24	4	18
Jun	16		10	10	24	23	4	18
Jul	17	25	9	8	22	21	17	19
Aug	17	26	7	6	25	24	17	20
Sep	21	35	8	8	36	29	19	23
Oct	16	24	9	8	23	21	20	17
Nov	15	21	8	7	22	21	19	16
Dec	14	24	9	8	20	19	13	15
2012								
Jan	20	32	9	9	27	26	14	21
Feb	19	28	9	9	24	23	15	20
Mar	16	24	8	8	20	20	18	17
Apr	14	20	7	7	17	17	15	14
May	15	23	9	9	20	21	17	15
Jun	16	27	11	11	24	23	18	17
Jul	15	28	11	11	24	24	17	17
Aug	14	22	8	8	18	18	16	15
Sep	14	23	9	8	20	21	17	15
Oct	16	26	10	10	23	22	18	17
Nov	15	29	11	11	25	24	17	17

Source: DEC Nuwara Eliya and AgCo

Table 3: Sales of UPEPV to Leading Traders

Trader	Quantity (kg)		Value (Rs.mn)		As a % of Total Quantity		As a % of Total Value	
	2011	2012	2011	2012	2011	2012	2011	2012
IFCO	11194	6391	22.59	15.00	36.49	33.3	43.24	40.33
Eastern	15153	7312	22.60	10.47	49.4	38.1	43.25	28.15
Trader 1	1396	3218	1.35	8.64	4.55	16.77	2.59	23.21
Trader 2	435	1396	0.81	1.35	1.42	7.27	1.55	3.64
Trader 3	813	406	1.84	1.05	2.65	2.12	3.52	2.83
Trader 4	727	167	1.56	0.37	2.37	0.87	2.98	0.98
Trader 5	961	303	1.50	0.32	3.13	1.58	2.87	0.85

Source: UPEPV

Table 4: Purchased Quantities of High Value Vegetables by UPEPV 2010 – 2012 (kg)

Item	Quantity (kg)			Change % 2010-11	Change % 2011-12
	2010	2011	2012		
Celery	1214	220		-82	
Chinese cabbage	4134	670		-84	
Cucumber	6005	7583	5070	26	-33
Green Pepper	7666	6258	3980	-18	-36
Tomato PT	9304	14281	6847	54	-52
Yellow Pepper	3818	2971	3090	-22	4
Red Pepper	4512	2300	4671	-49	103
Ice Burg	2744	642		-77	
BP Gr 2	932	1311	1133	41	-14
Pak Choy	1412	424		-70	
Red Cabbage	685	205		-70	
Lettuce	45				

Source: UPEPV

Table 5: Margin between Producer Price and Wholesale Price in the Producing Areas

Item		Jan	Feb	Mar	Apr	May	Jun	Jul	Aug	Sep	Oct	Nov	Dec
Celery													
2010	Rs/kg	55	28	22	40	26	43	75	124	78	25	53	60
2011	Rs/kg		25	92	70	32		10	27				
2010	%	73	27	20	33	17	20	27	55	80	46	113	150
2011	%		20	39	140	36		7	24				
Chinese cabbage													
2010	Rs/kg	66	38	39	39	81	89	75	61	42	41	44	85
2011	Rs/kg		75	40				20	22	60	67	90	90
2010	%	88	62	66	69	85	80	60	53	39	35	41	213
2011	%		150	50				13	15	46	81	150	150
Cucumber													
2010	Rs/kg	20	28	25	25	30	20	40	38	33	30	30	26
2011	Rs/kg	58	50	129	53	44	50	40	39	44	41	36	40
2012	Rs/kg	63	60	18	24	26	30	52					
2010	%	22	33	29	29	34	18	36	44	50	43	43	35
2011	%	62	51	316	112	57	50	40	37	41	37	32	31
2012	%	108	107	24	35	38	41	80					
Green Pepper													
2010	Rs/kg	73	80	85	85	89	94	99	120	121	109	113	136
2011	Rs/kg	118	129	192	243	98	77	100	90	92	90	80	101
2012	Rs/kg	84	130	49	66	88	123	99					
2010	%	47	59	67	67	67	66	53	48	44	35	35	43
2011	%	35	35	62	130	107	62	71	48	37	34	29	41
2012	Min Rs/kg					9	27	19					
2012	%					10	22	13					
	%	39	111	81	63	55	70	58					
Tomato													
2010	Rs/kg	50	20	16	28	30	36	49	50	57	44	52	60
2011	Rs/kg	60	61	47	107	60	35	40	61	50	50	79	32
2012	Rs/kg	15	68	60	56	38	70	56	57				
2012	Rs/kg	40	133	70	76	68		61	67				
2010	%	71	29	24	44	46	48	64	67	72	52	68	86
2011	%	86	69	36	115	86	64	80	103	71	71	87	24
2012	%	21	163	150	125	38	69	49	77				
2012	%	56	319	175	170	67		54	91				

Source:

Table 5: Margin between Producer Price and Wholesale Price in the Producing Areas

Item		Jan	Feb	Mar	Apr	May	Jun	Jul	Aug	Sep	Oct	Nov	Dec
Yellow Pepper													
2010	Rs/kg	68	98	93	120	120	93	53	121	102	94	95	69
2011	Rs/kg	106	89	155	208	35	98	-5	18	64	50	51	86
2012	Rs/kg	75	125	40	30	120	70	20					
	%	24	42	47	85	73	45	18	37	28	23	21	14
2010	Rs/kg	78	118	123	135	135	113	128	141	132	119		
	%	28	51	62	96	82	55	43	43	36	29		
2011	%	19	15	28	42	38	74	-3	7	18	12	11	17
	%	25	50	67	27	52	41	12					
2012	Rs/kg	110	125	145	120	70	95	25					
	%	20	33	81	52	21	29	8					
Red Pepper													
2010	Rs/kg	24	53	57	127	116	74	58	114	103	89	99	66
2011	Rs/kg	21	95	125	331	175	93	102	92	85	80	112	173
2012	Rs/kg	144	90	89	86	98	60	222					
2010	%	9	26	33	86	73	33	20	34	27	22	22	13
2011	%	4	16	20	90	167	45	51	32	23	19	25	40
2012	%	40	32	98	76	54	25	107					
Iceberg													
2010	Rs/kg	65	35	36	55	31	75	168	95	28	22	39	32
2011	Rs/kg	25						30	50	10	55	70	
2010	%	42	47	49	68	12	25	81	68	46	28	35	28
2011	%	20						25	38	8	58	88	
BP Gr 2													
2010	Rs/kg	80	18	27	30	31	40	40	50	45	80	100	100
2011	Rs/kg				8	23	65	90					
2012	Rs/kg	30	22	7	11	16	39	36	42				
2010	%	114	56	114	150	157	100	100	125	99	160	200	200
2011	%				20	84	147	225					
2012	%	60	58	55	38	46	107	106	124				
2012	Rs/kg	90	32		31	41							
	%	180	84		107	119							
Pak Choy													
2010	Rs/kg	30	20	38	48	53	63	100	24	22	55	76	85
2011	Rs/kg	25				25		20	20	44	53		
2010	%	46	31	65	84	55	66	111	32	28	122	119	131
2011	%	38				50		29	29	95	145		
Red Cabbage													
2010	Rs/kg	60	65	25	46	43					50	61	
2011	Rs/kg	75			25							80	
2010	%	63	54	16	33	35					22	28	
2011	%	38			14							114	

Source: UPEPV

Annex 2: Price Behaviour of High Value Highly Perishable Vegetables

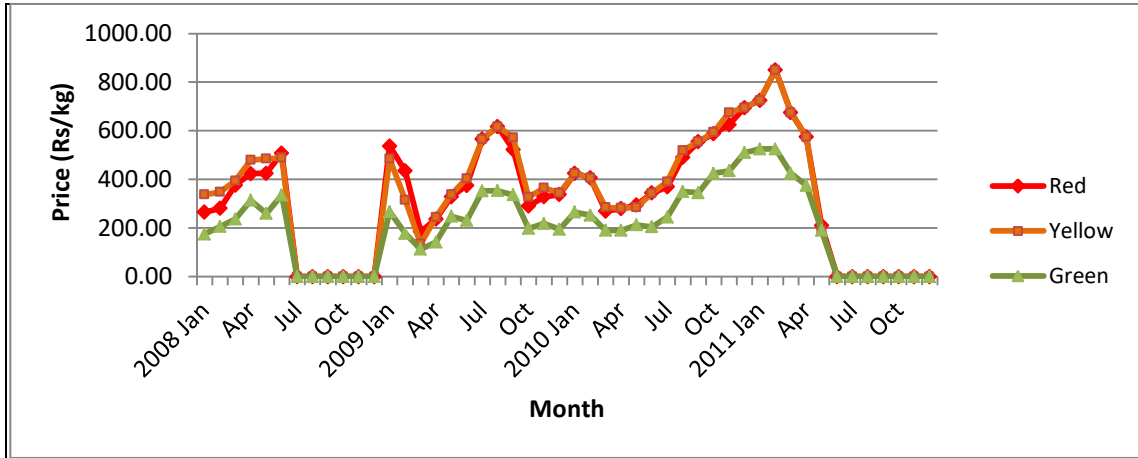

Monthly Average Wholesale Prices of Bell Pepper at Economic Centre in Nuwara Eliya 2008-2011

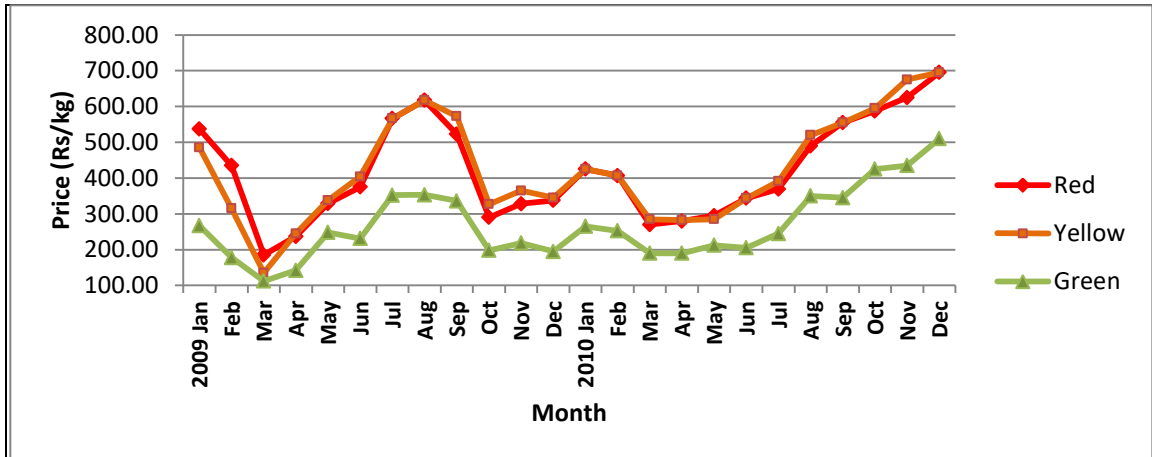

Wholesale Prices of Bell Pepper at Economic Centre in Nuwara Eliya 2009-2010

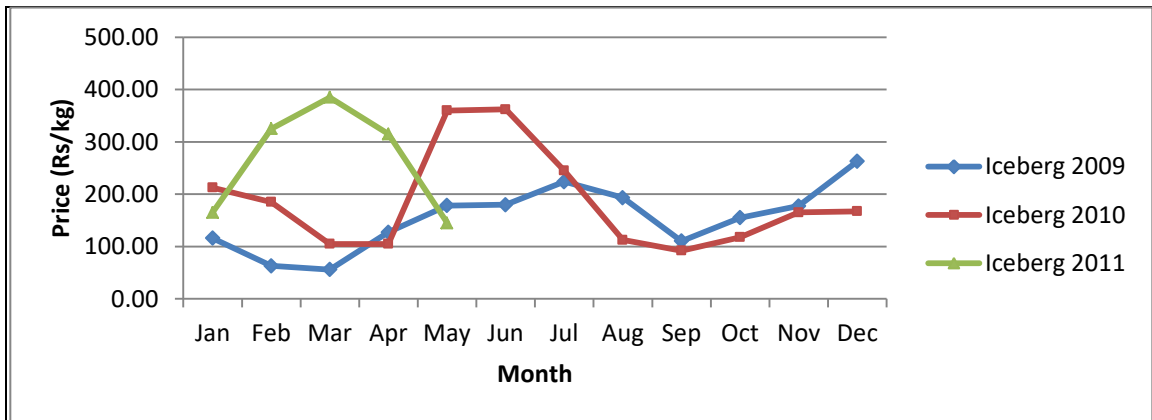

Monthly Average Wholesale Prices of Ice berg at Economic Center in Nuwara Eliya 2009-2011

Source: Marketing Food Policy and Agribusiness Division/HARTI

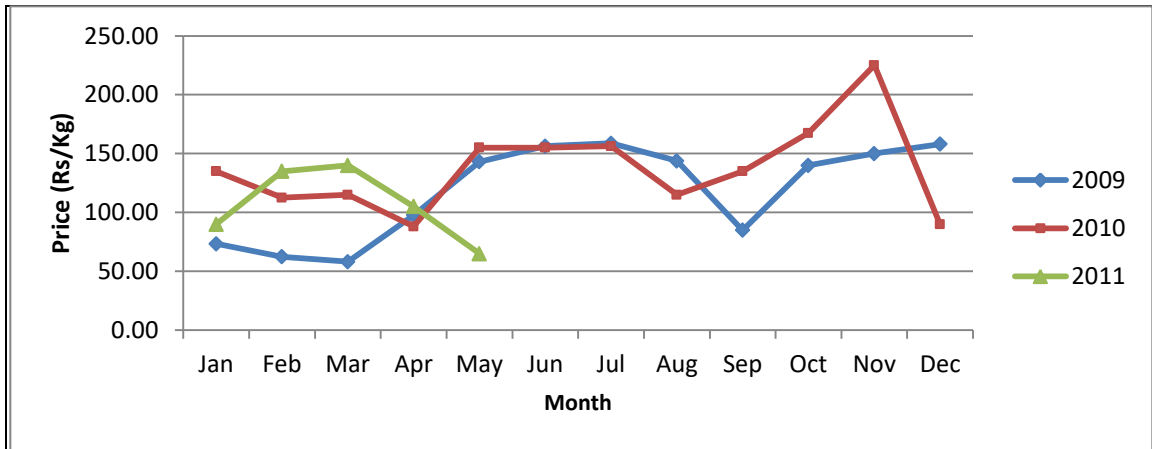

Monthly Average Wholesale Prices of Chinese Cabbage at Economic Center in Nuwara Eliya 2009-2011

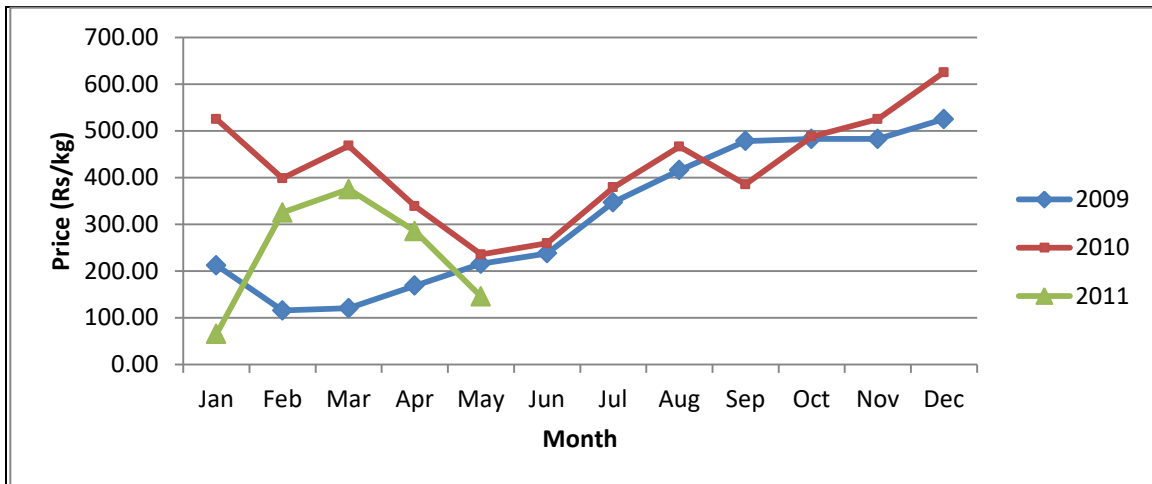

Monthly Average Wholesale Prices of Broccoli at Economic Center in Nuwara Eliya 2009-2011

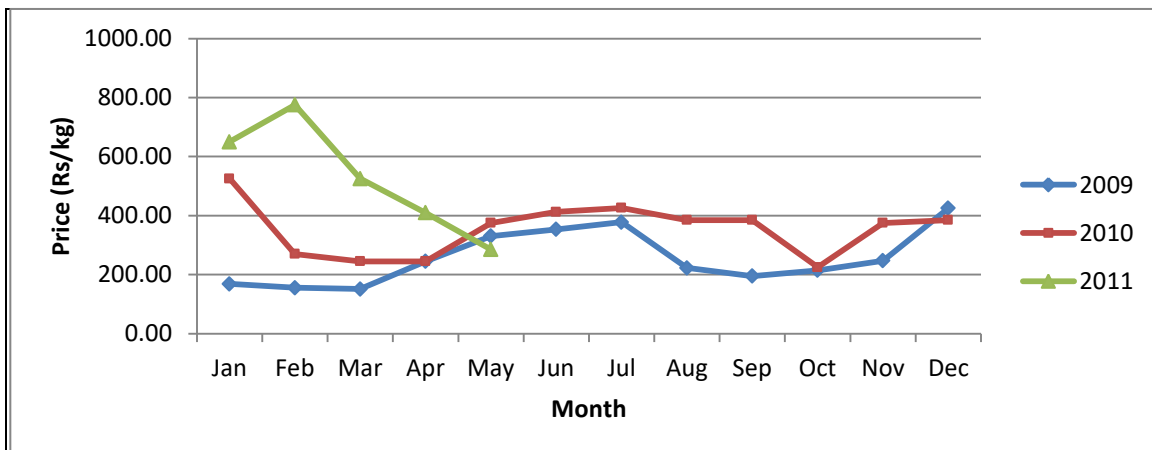

Monthly Average Wholesale Prices of Cauliflower at Economic Center in Nuwara Eliya 2009-2011

Source: Marketing Food Policy and Agribusiness Division/HARTI

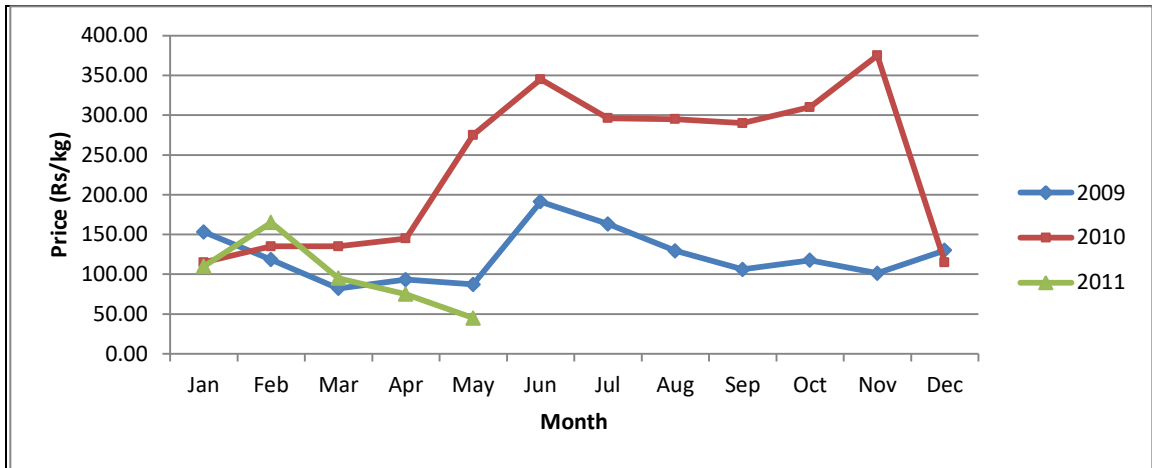

Monthly Average Wholesale Prices of Lettuce -Red at Economic Center in Nuwara Eliya 2009-2011

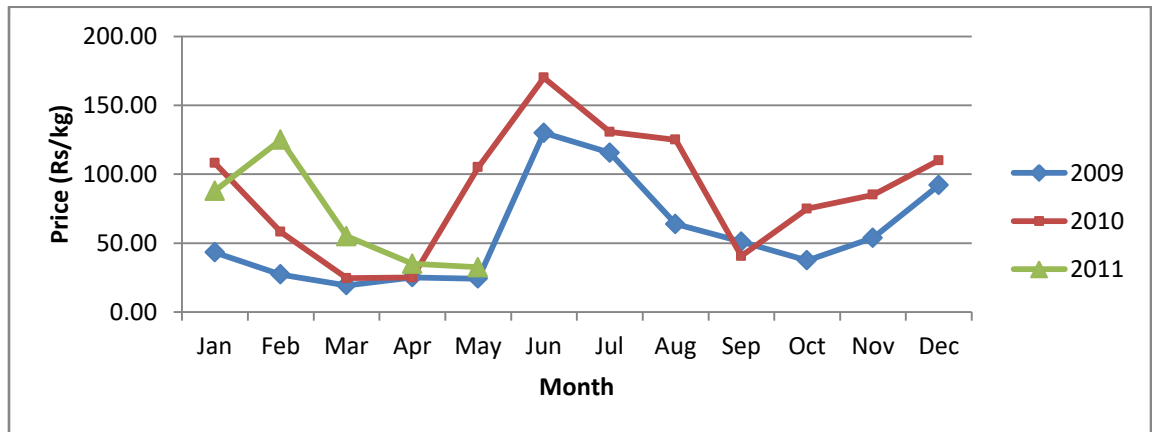

Monthly Average Wholesale Prices of Lettuce -Green at Economic Center in Nuwara Eliya 2009-2011

Source: Marketing Food Policy and Agribusiness Division/HARTI

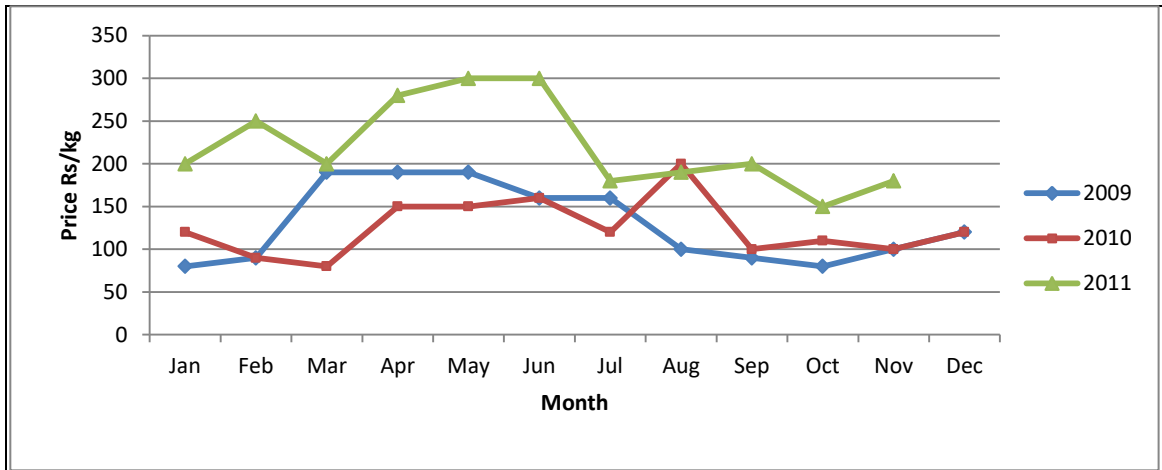

Retail Prices of Lettuce Green at Pettah Market 2009-2011

Source: Dept. of Census & Statistics

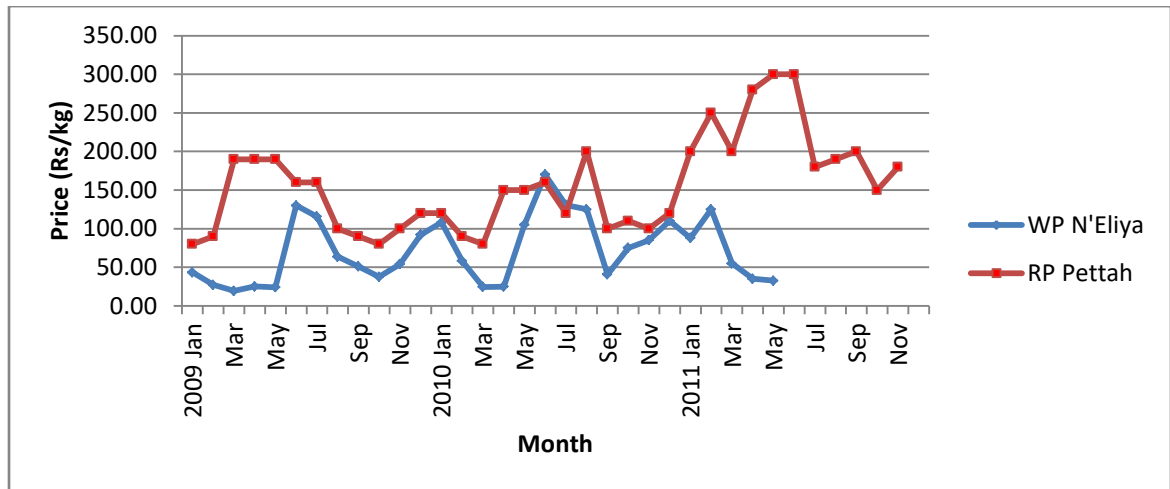

Wholesale and Retail Prices of Lettuce - Green

Source: Dept. of Census & Statistics

Marketing Food Policy and Agribusiness Division/HARTI

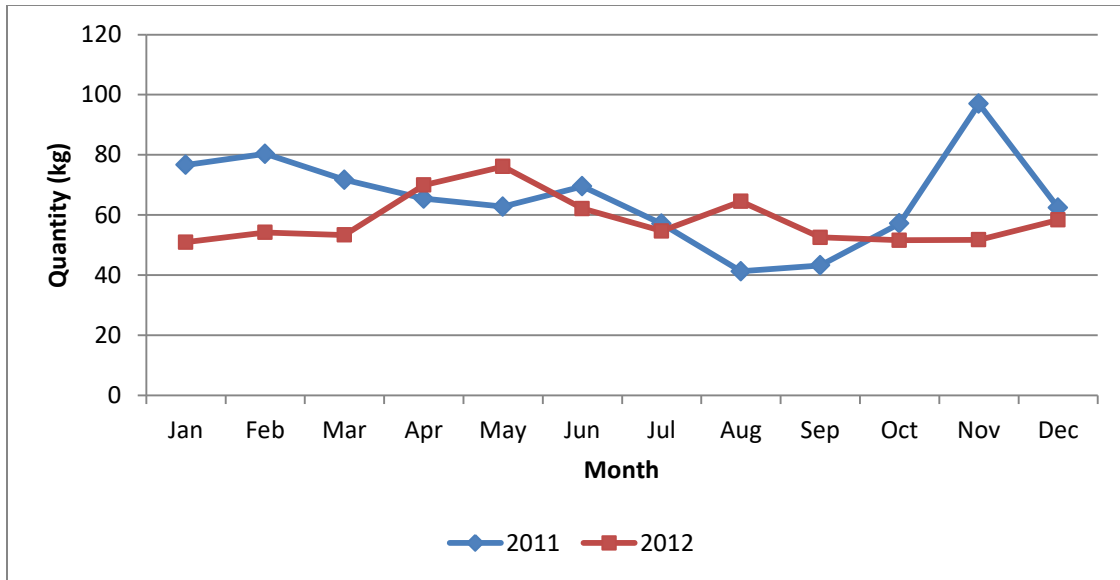

Average Daily Demand of Tomato Grown in Poly Tunnels from Collectors in Nuwara Eliya 2011 & 2012

Annex 3: Monthly Average Producer Prices & Purchases of Leading Collectors in Nuwara Eliya Jan 2011 –Nov 2012

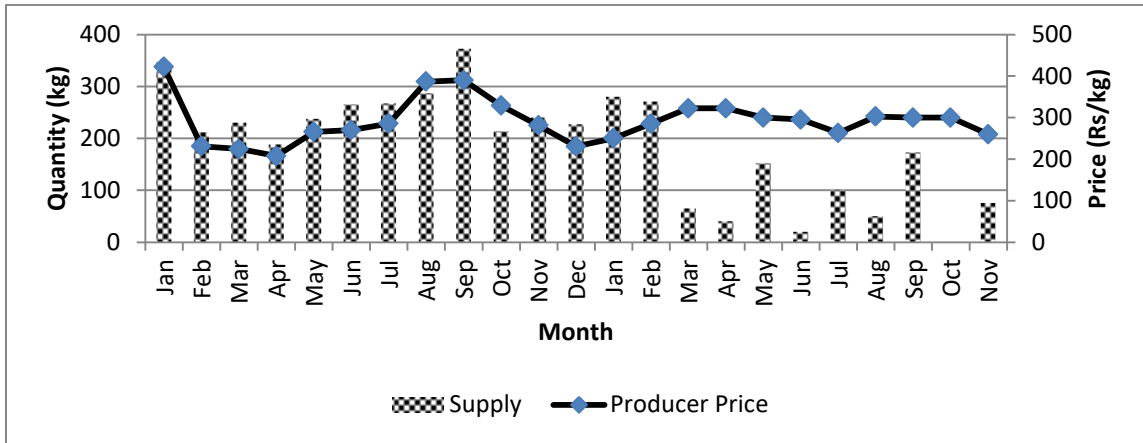

Monthly Average Producer Prices & Purchases of Bell Pepper - Green

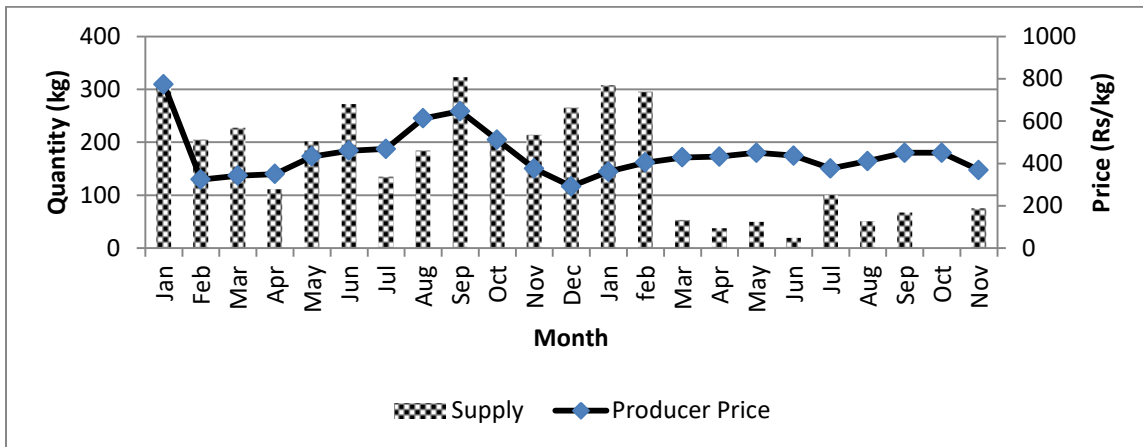

Monthly Average Producer Prices & Purchases of Bell Pepper – Red

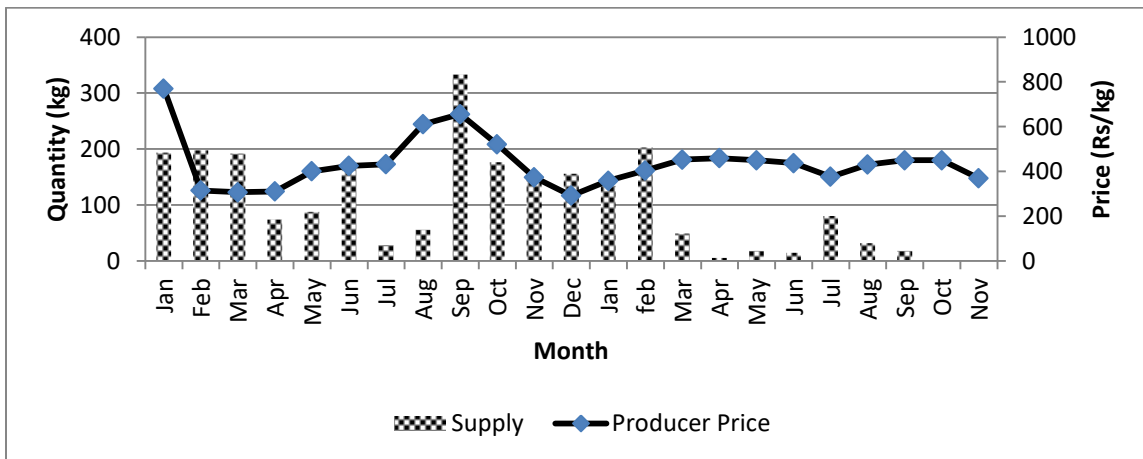

Monthly Average Producer Prices & Purchases of Bell Pepper - Yellow

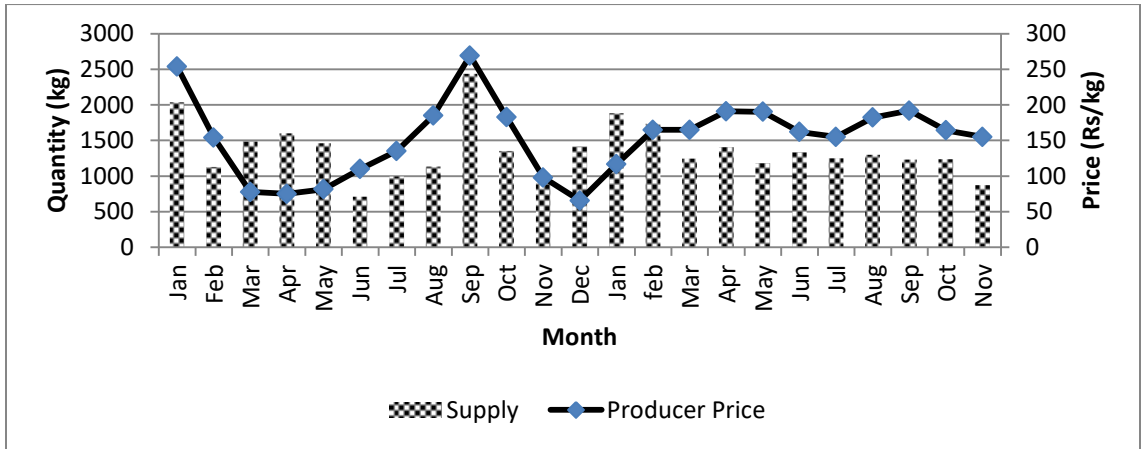

Monthly Average Producer Prices & Purchases of Tomato Grown in Poly Tunnel

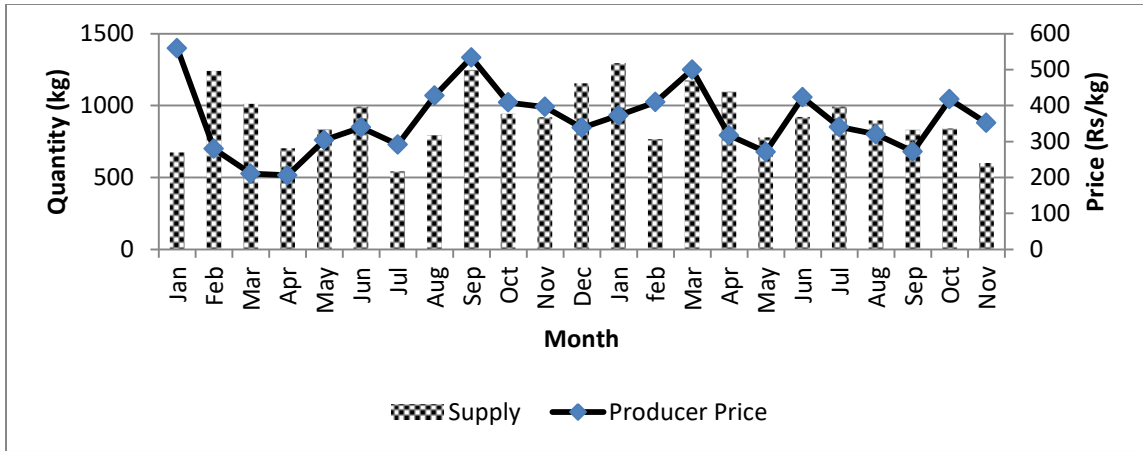

Monthly Average Producer Prices & Purchases of Broccoli

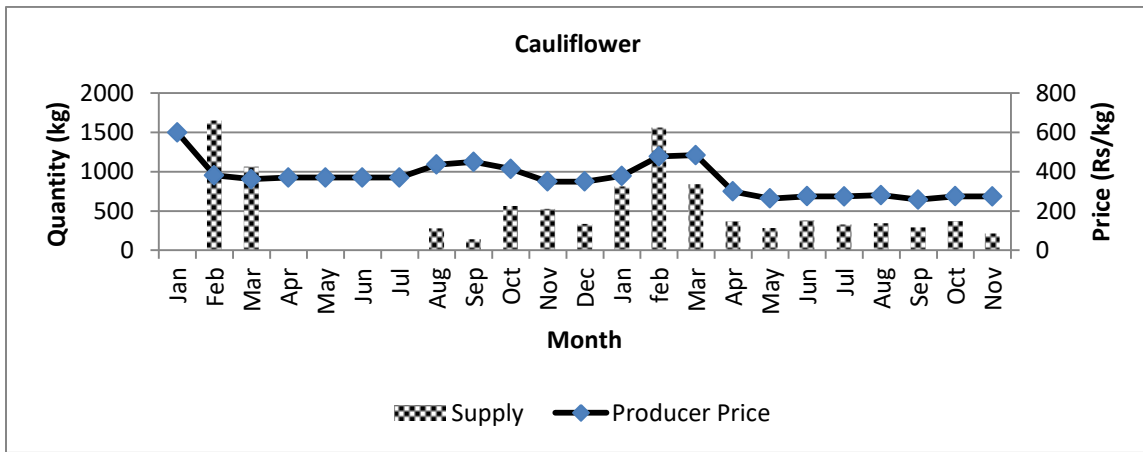

Monthly Average Producer Prices & Purchases of Cauliflower

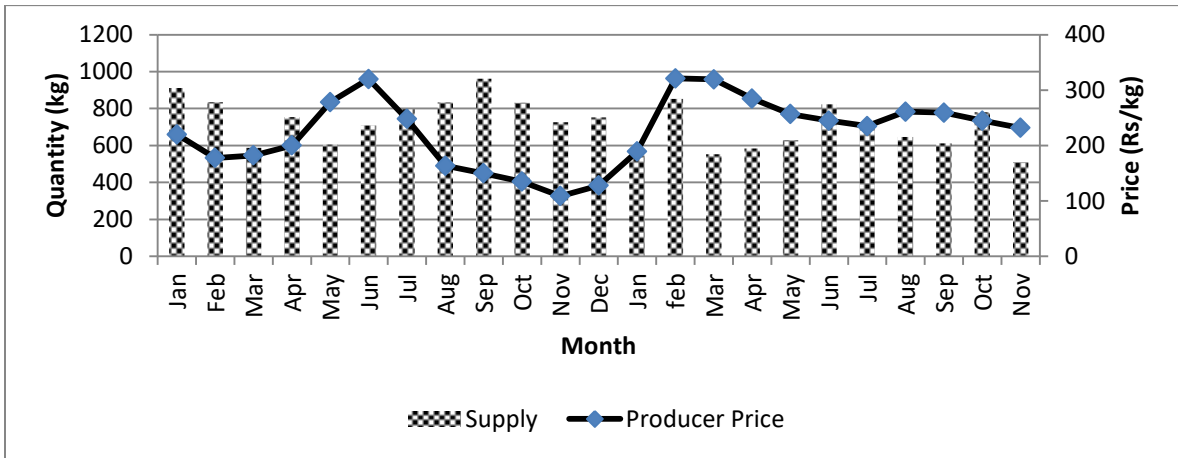

Monthly Average Producer Prices & Purchases of Chinese Cabbage

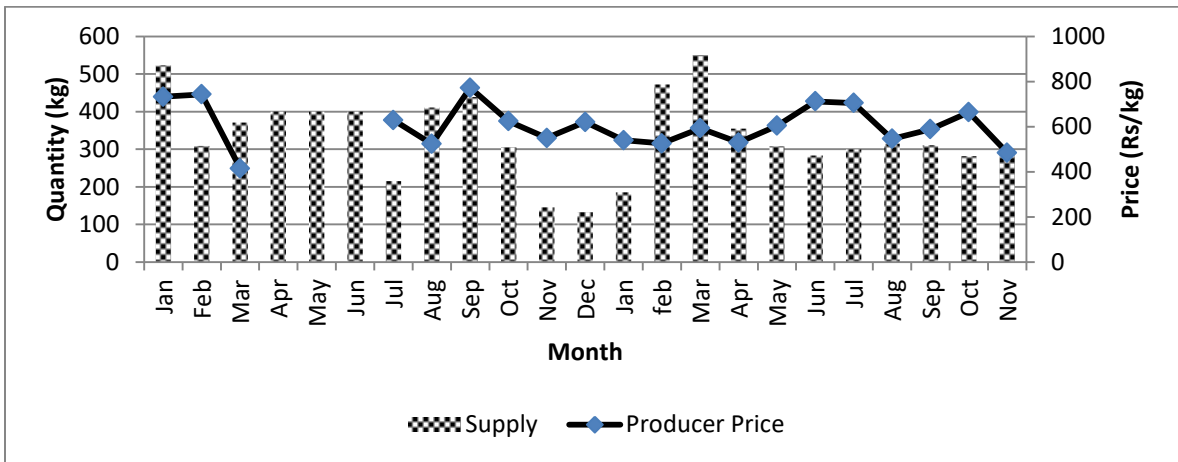

Monthly Average Producer Prices & Purchases of Ice burg

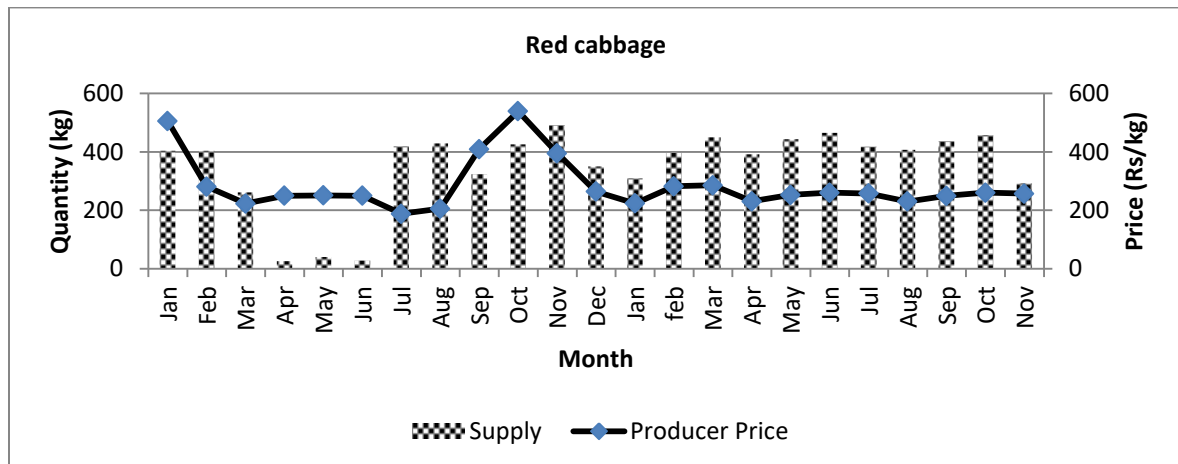

Monthly Average Producer Prices & Purchases of Red Cabbage

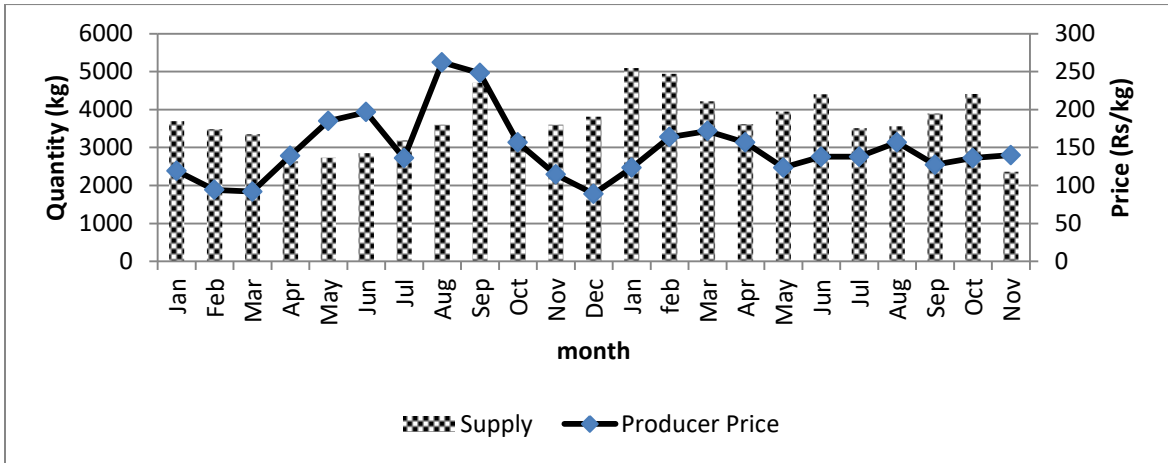

Monthly Average Producer Prices & Purchases of Lettuce -Green

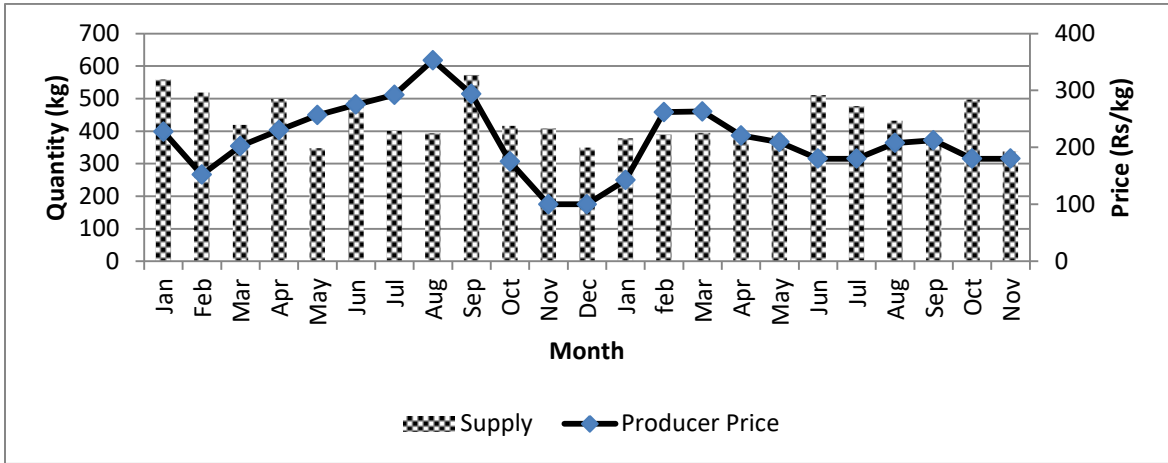

Monthly Average Producer Prices & Purchases of Lettuce – Red

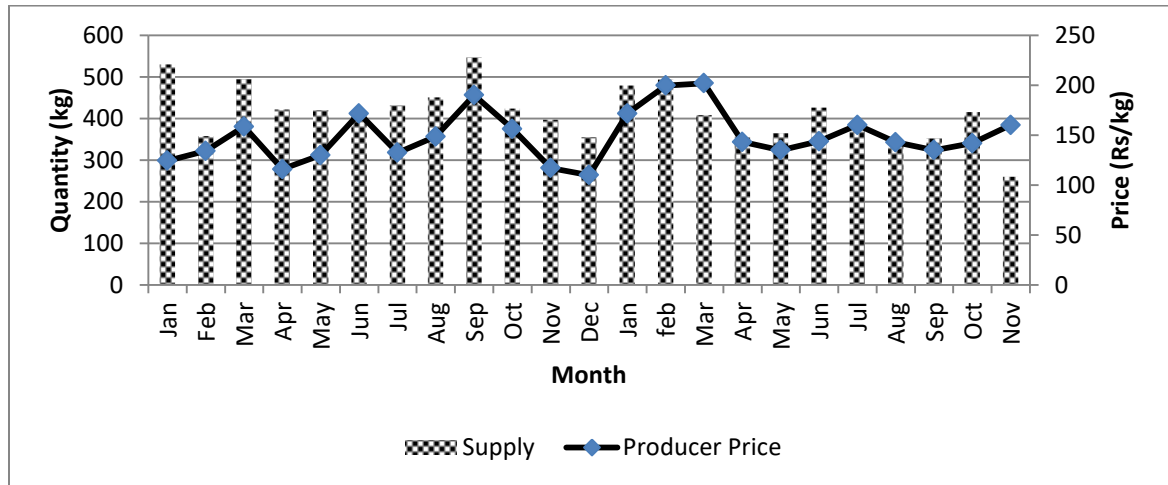

Monthly Average Producer Prices & Purchases of Pak Choy

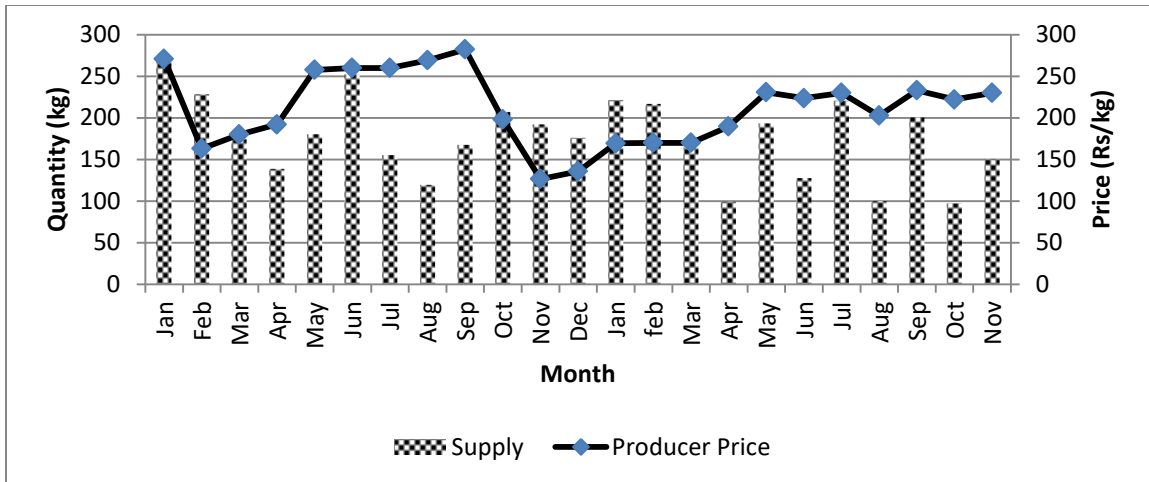

Monthly Average Producer Prices & Purchases of Zucchini - Yellow

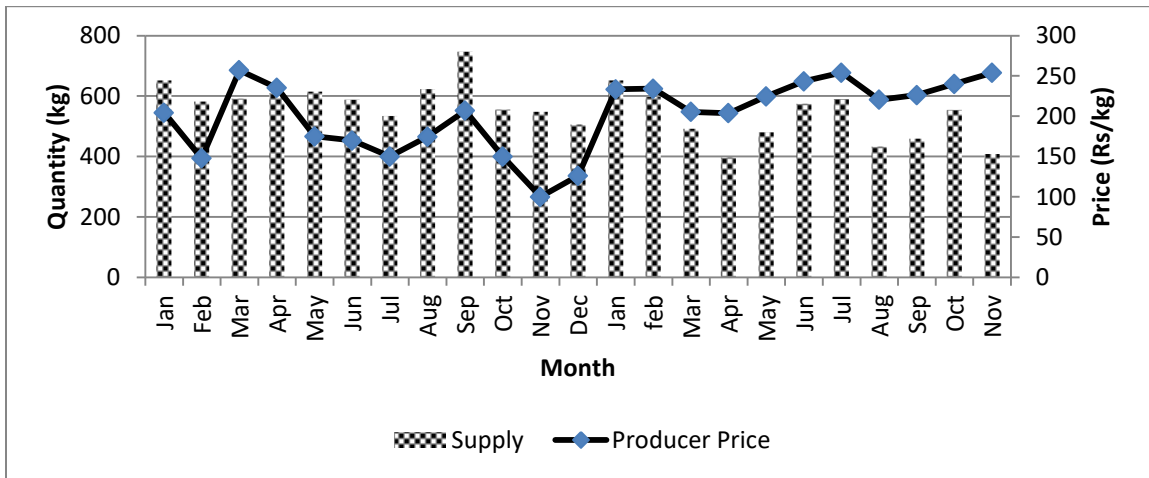

Monthly Average Producer Prices & Purchases of Zucchini - Green

Source: AgCo- Nuwara Eliya

Annex 4: Monthly Average Producer Prices & Purchased Quantities of Uva Paranagama Export Production Village Ltd



Monthly Average Producer Prices & Purchased Quantities of Cucumber



Monthly Average Producer Prices & Purchased Quantities of Bell Pepper –Green



Monthly Average Producer Prices & Purchased Quantities of - Red

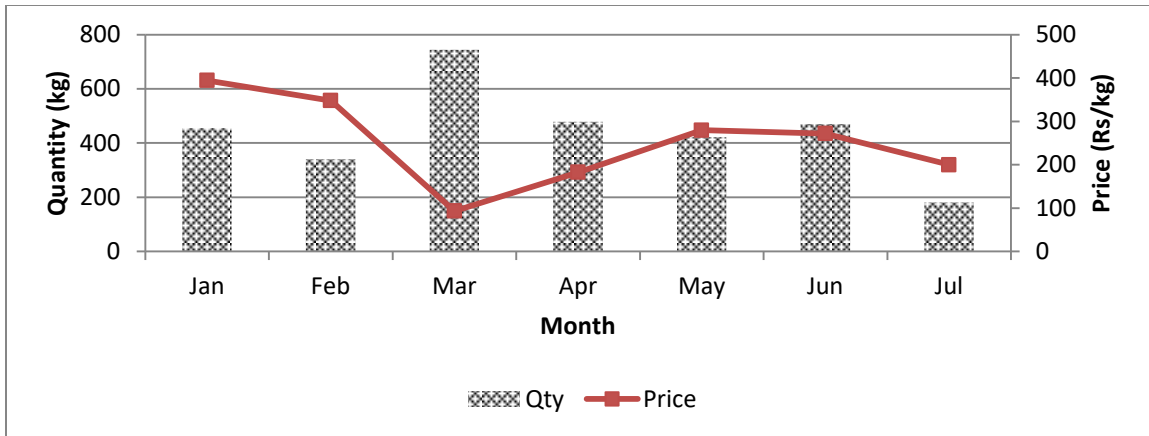

Monthly Average Producer Prices & Purchased Quantities of Bell Pepper – Yellow

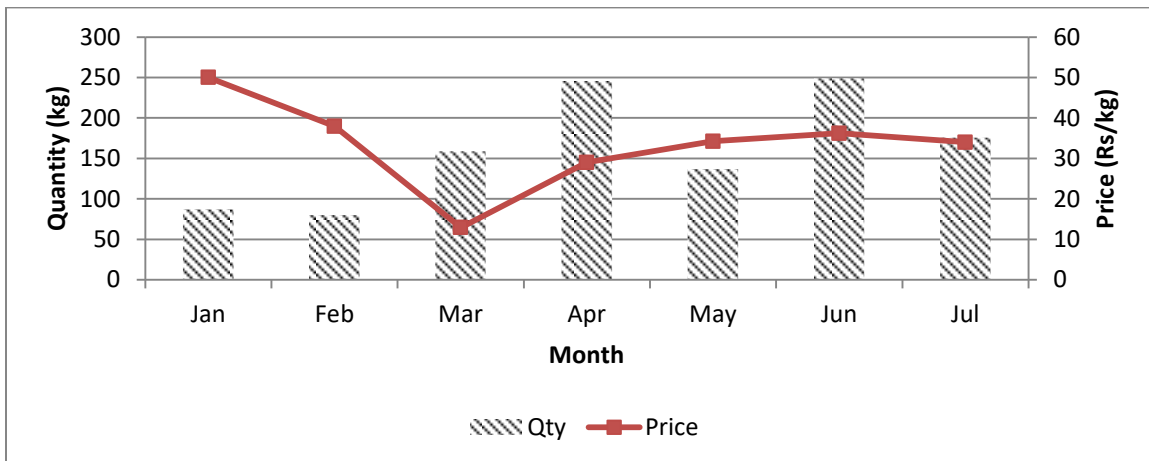

Monthly Average Producer Prices & Purchased Quantities of Bell Pepper Grade II

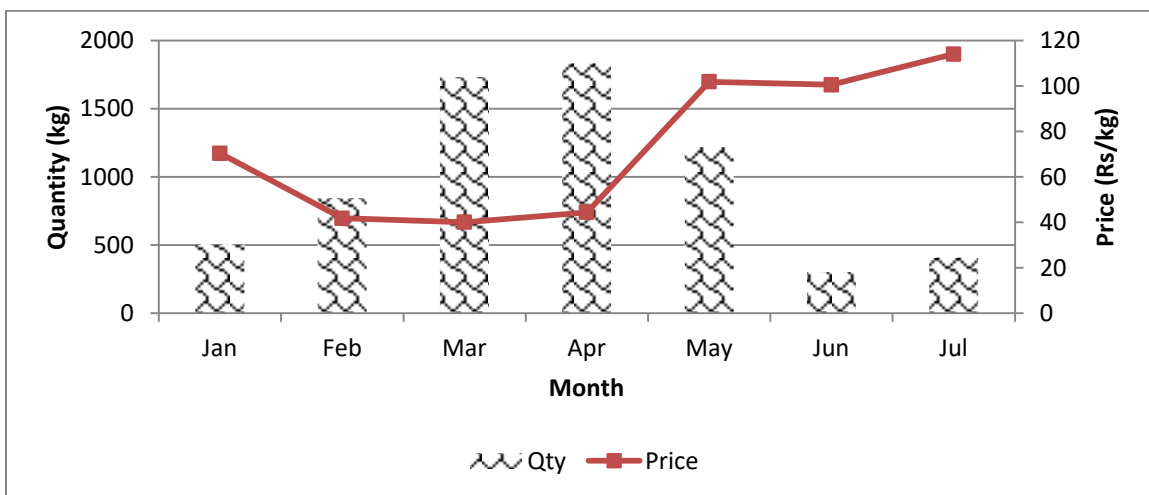

Monthly Average Producer Prices & Purchased Quantities of Tomato Grown in Poly Tunnels

Annex 5: Monthly Average Producer Prices of High Value Highly Perishable Vegetables in Uva Paranagama Area 2010 - 2011-2012

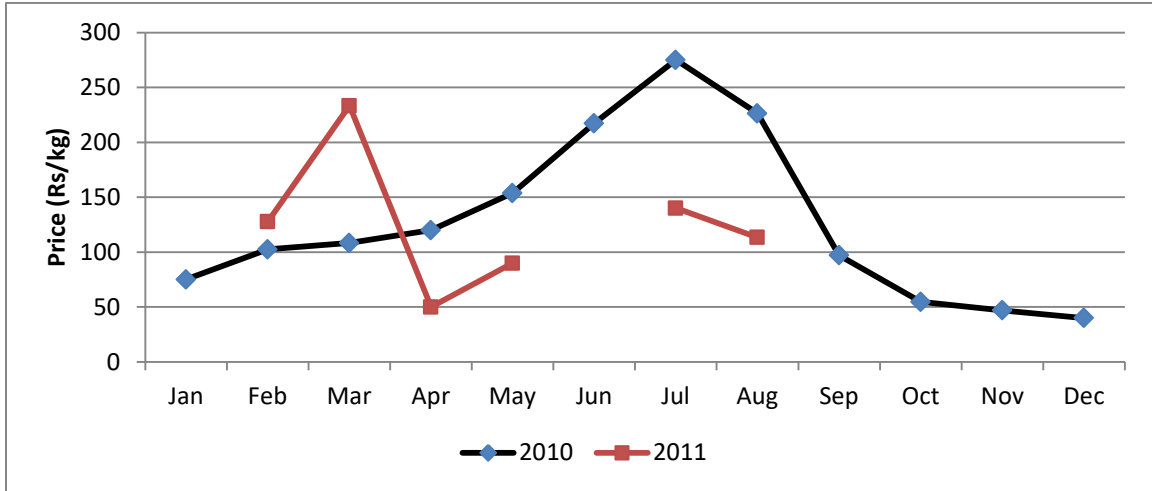

Monthly Average Producer Prices of Celery (Rs/kg)

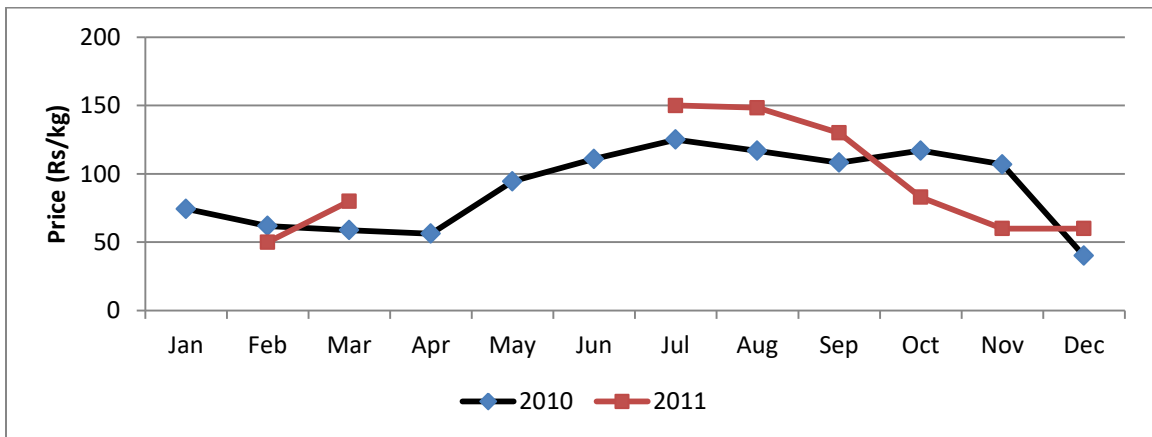

Monthly Average Producer Prices of Chinese Cabbage (Rs/kg)

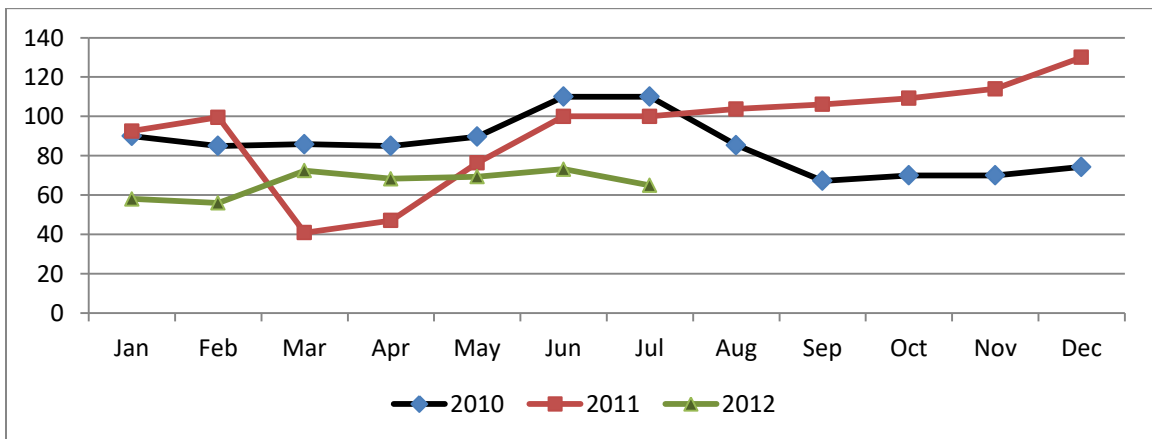

Monthly Average Producer Prices of Cucumber Green (Rs/kg)

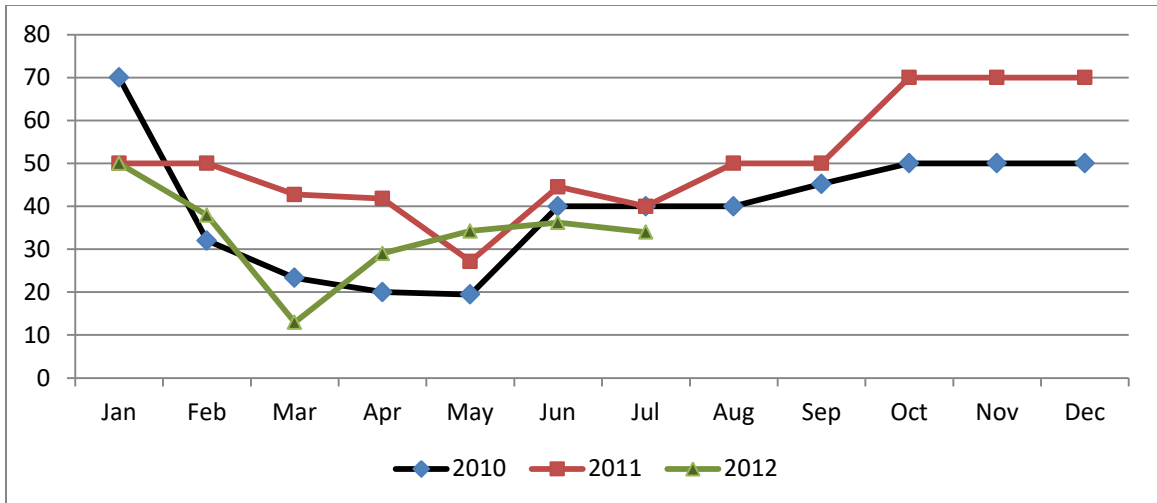

Monthly Average Producer Prices of Bell Pepper Gr. II (Rs/kg)

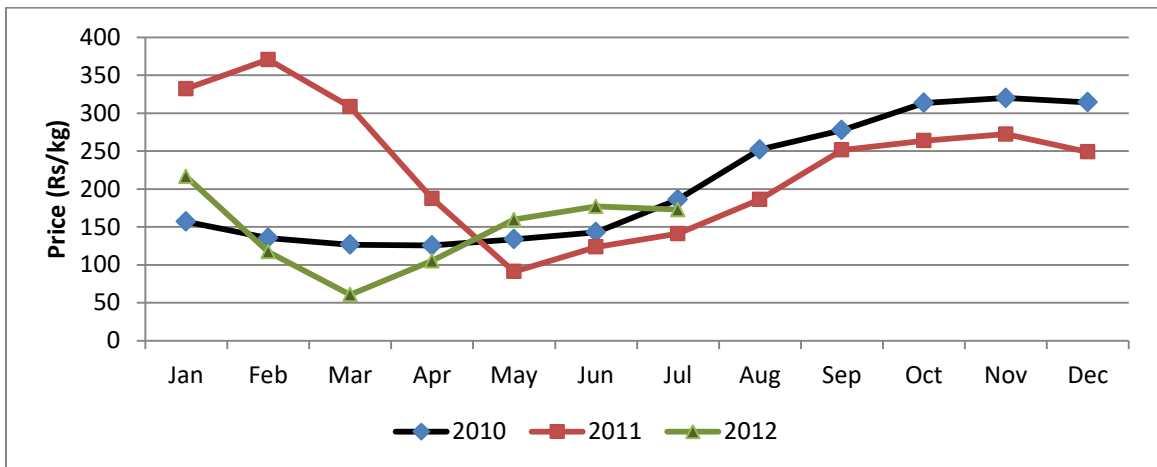

Monthly Average Producer Prices of Bell Pepper Green (Rs/kg)

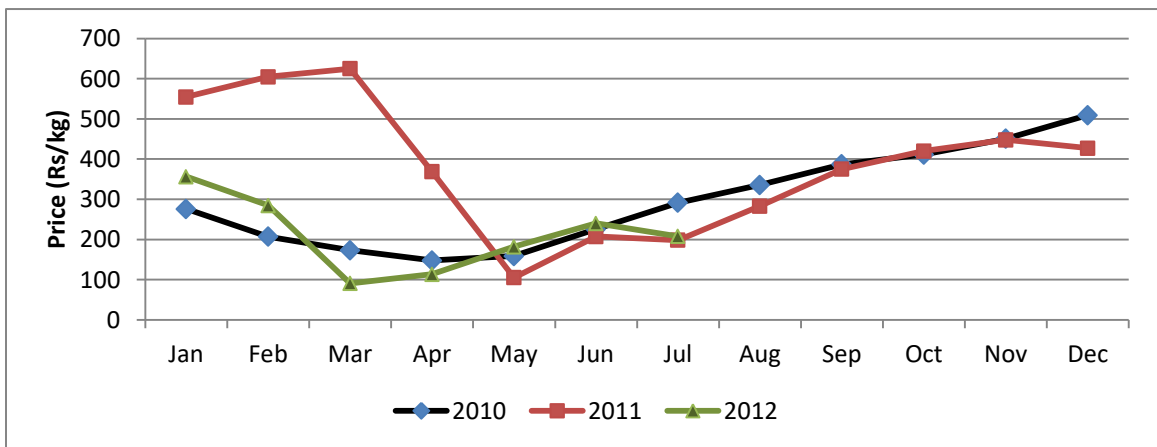

Monthly Average Producer Prices of Bell Pepper Red (Rs/kg)

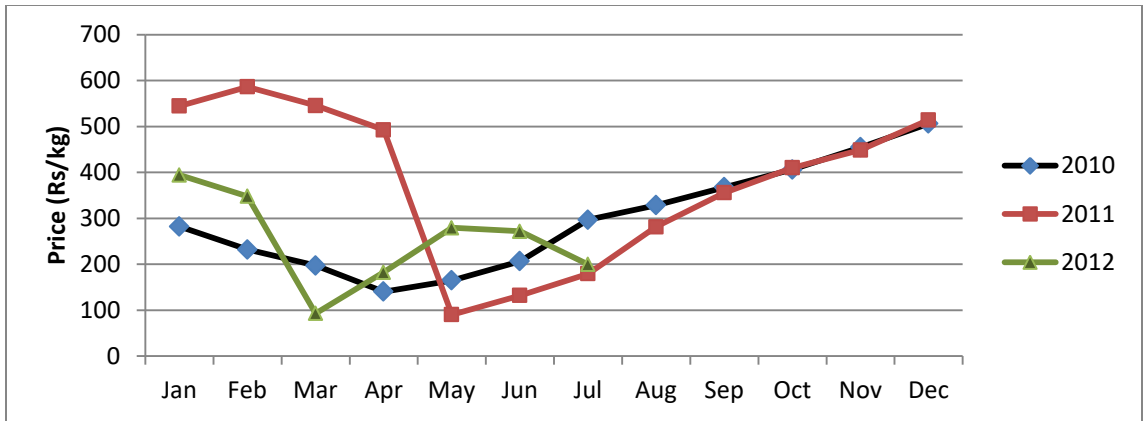

Monthly Average Producer Prices of Bell Pepper Yellow (Rs/kg)

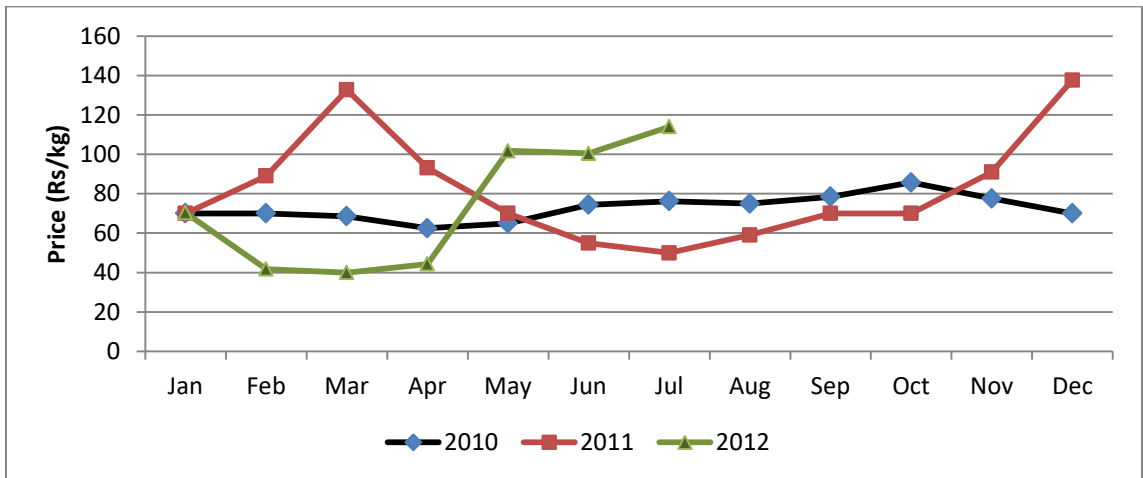

Monthly Average Producer Prices of Tomato PT (Rs/kg)

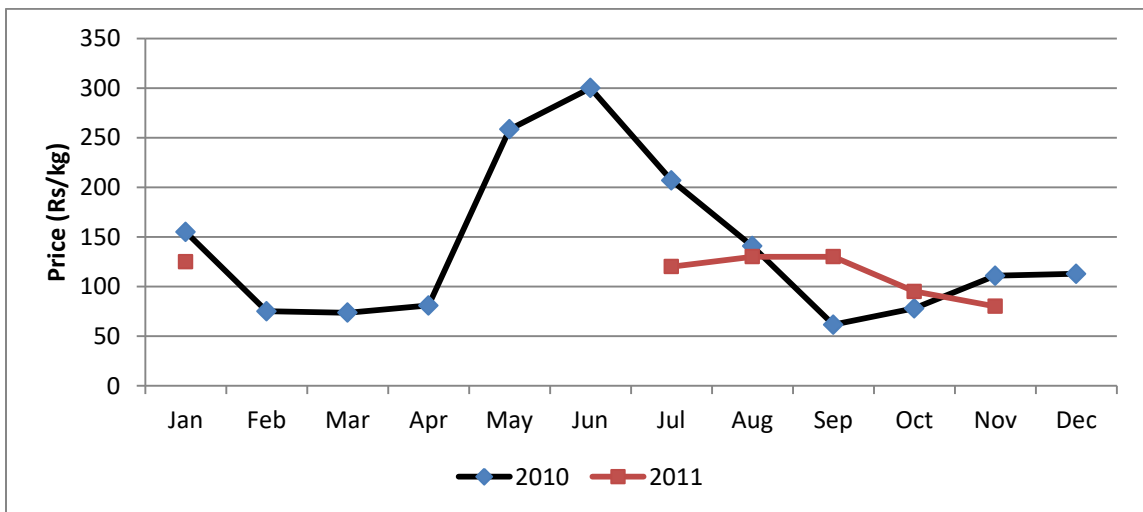

Monthly Average Producer Prices of Ice Burg (Rs/kg)

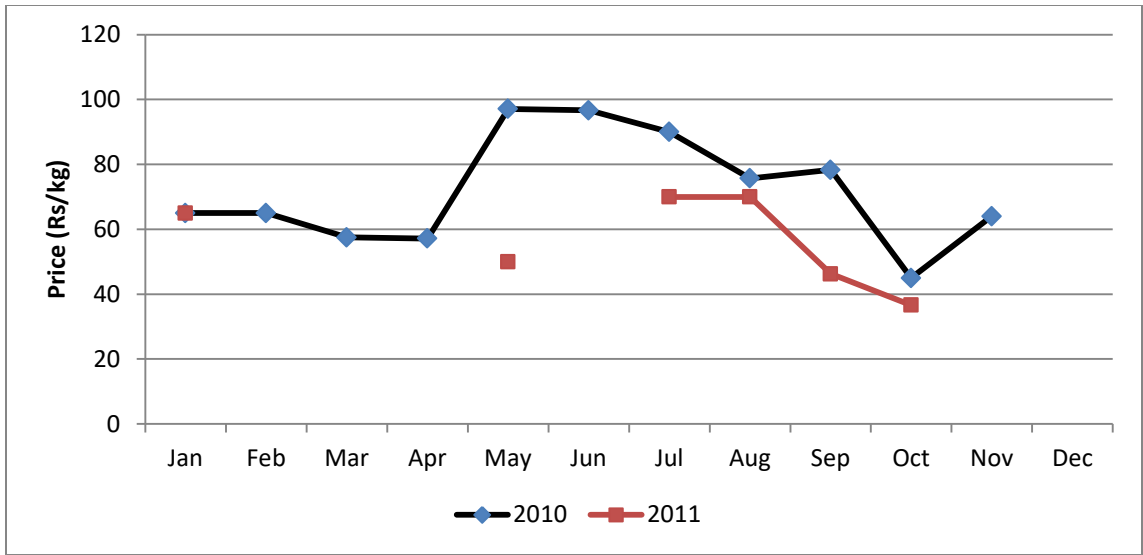

Monthly Average Producer Prices of Pak Choy (Rs/kg)

Source: Uva Paranagama Export Production Village (UPEPV) & Collectors

Annex 6: Monthly Average Producer Prices of High Value Highly Perishable Vegetables in Nuwara Eliya 2011-2012

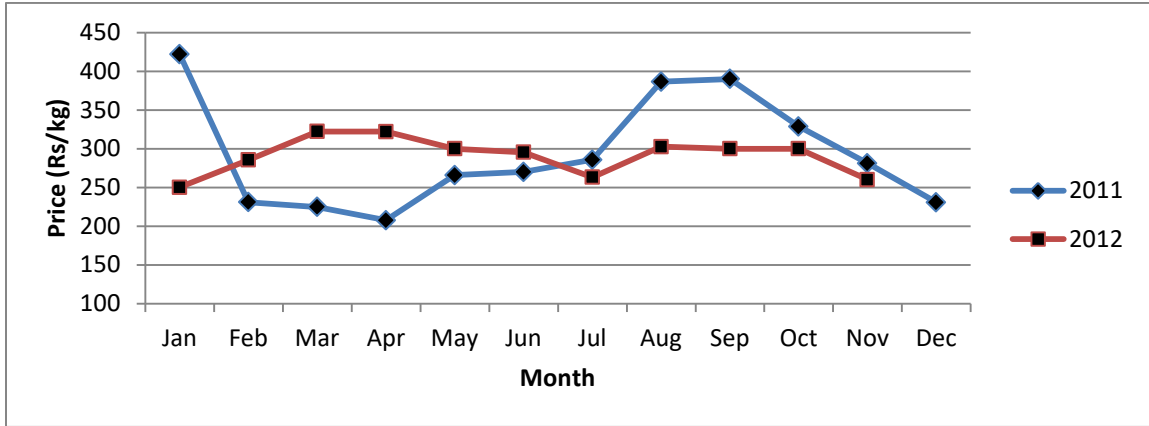

Monthly Average Producer Prices of Bell Pepper - Green

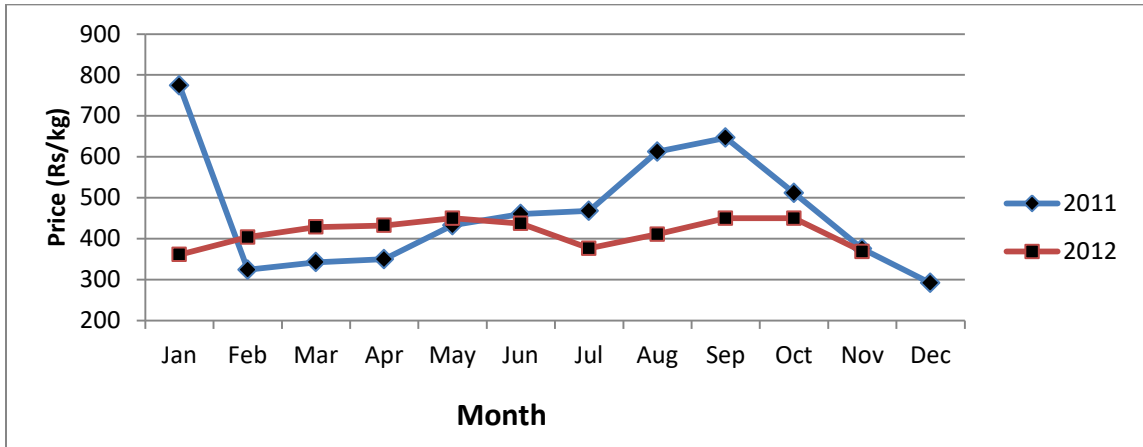

Monthly Average Producer Prices of Bell Pepper - Red

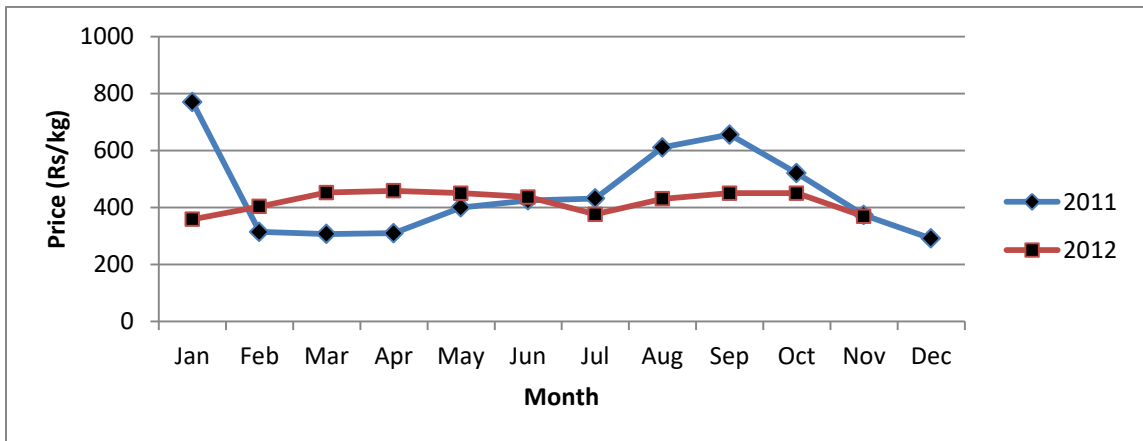

Monthly Average Producer Prices of Bell Pepper - Yellow

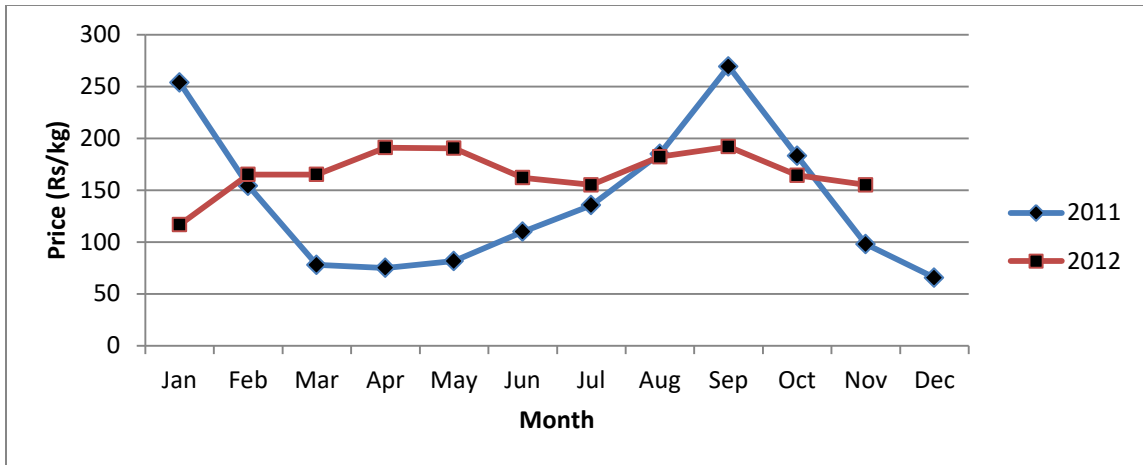

Monthly Average Producer Prices of Green House Tomato

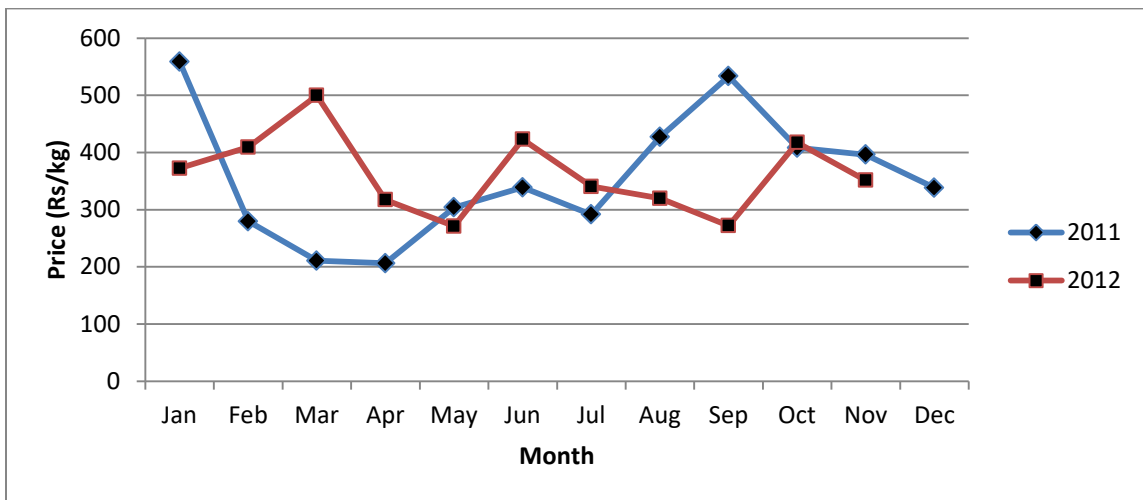

Monthly Average Producer Prices of Broccoli

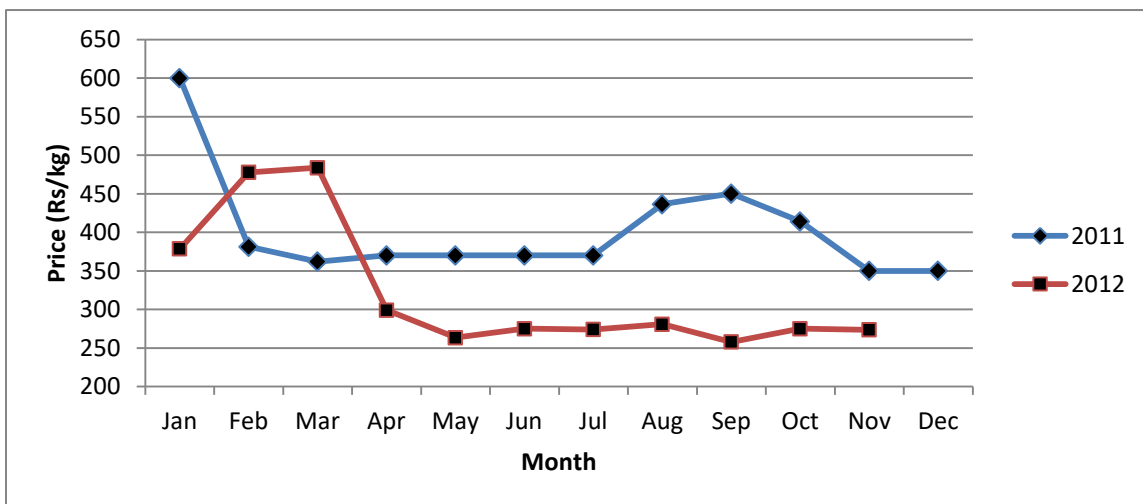

Monthly Average Producer Prices of Cauliflower

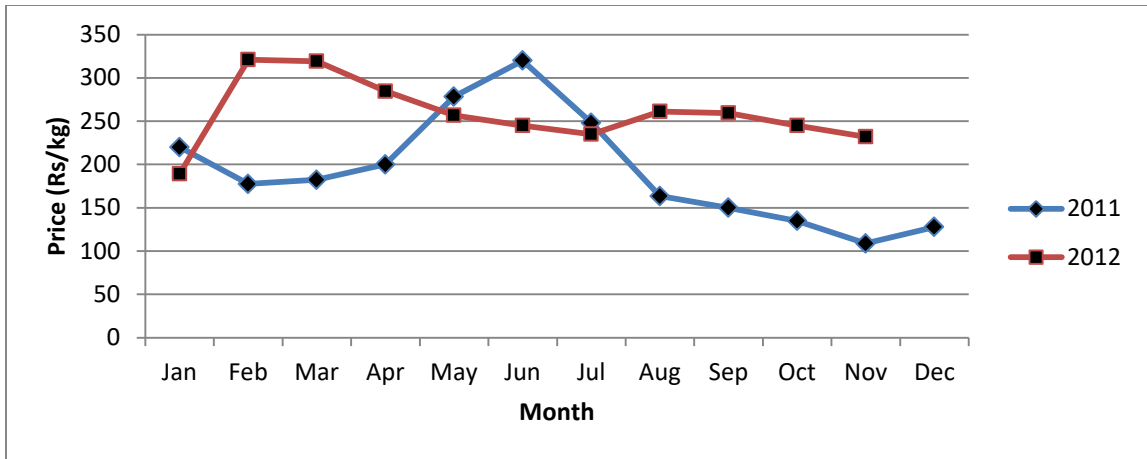

Monthly Average Producer Prices of Chinese Cabbage

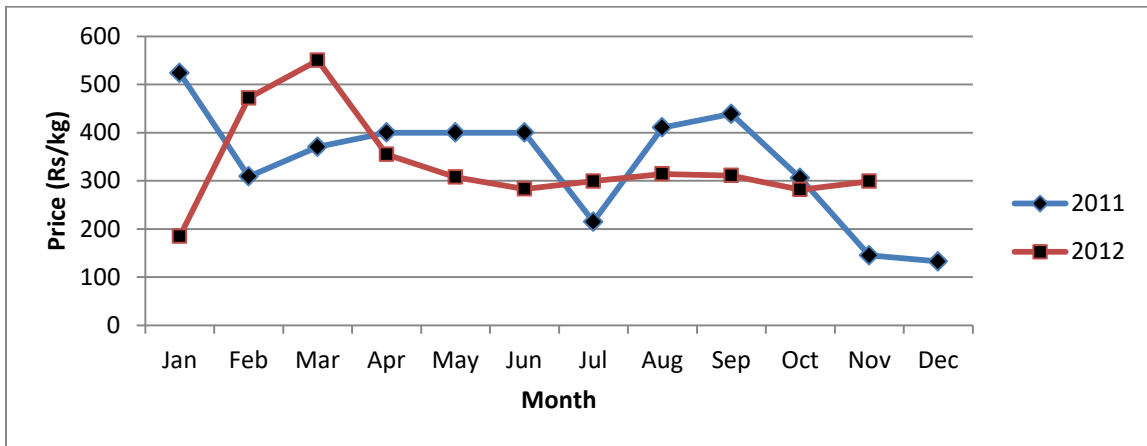

Monthly Average Producer Prices of Iceberg

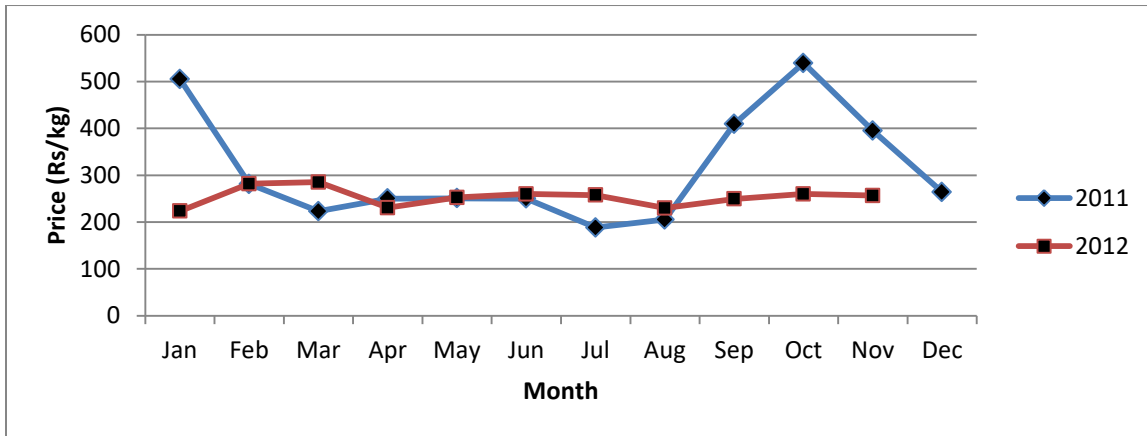

Monthly Average Producer Prices of Red Cabbage

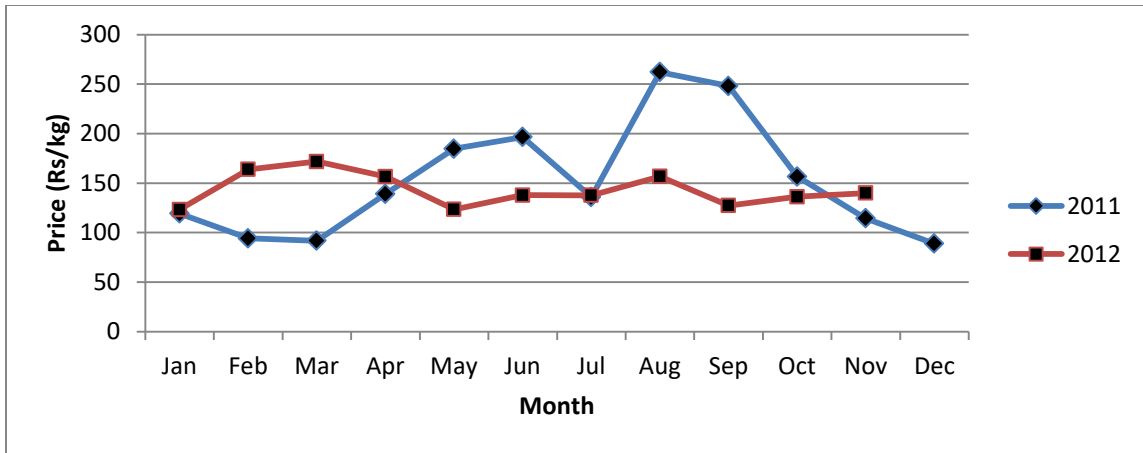

Monthly Average Producer Prices of Lettuce -Green

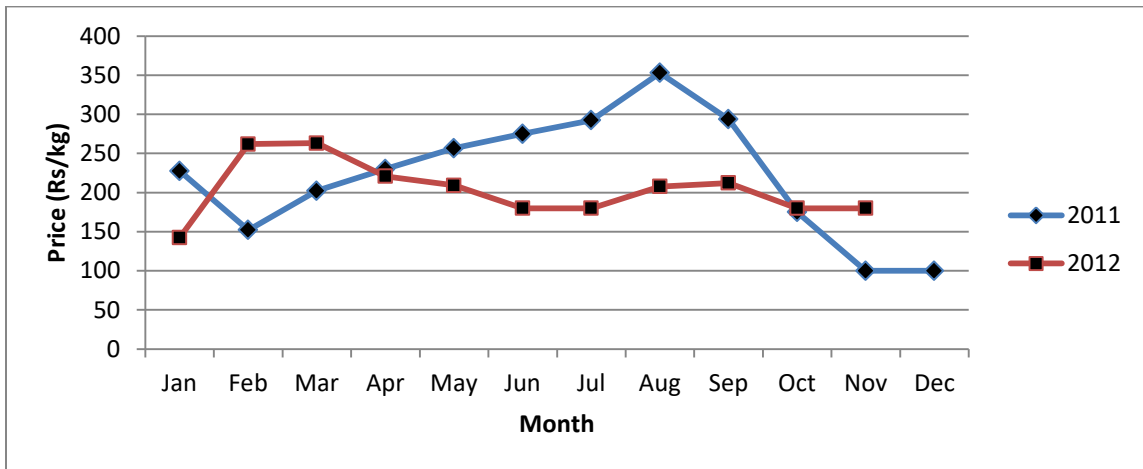

Monthly Average Producer Prices of Lettuce - Red

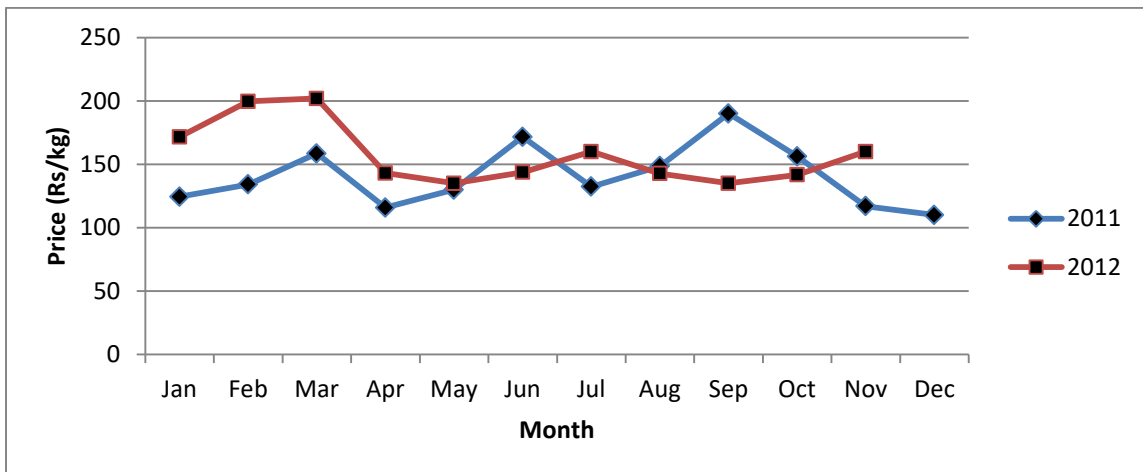

Monthly Average Producer Prices of Pak Choy

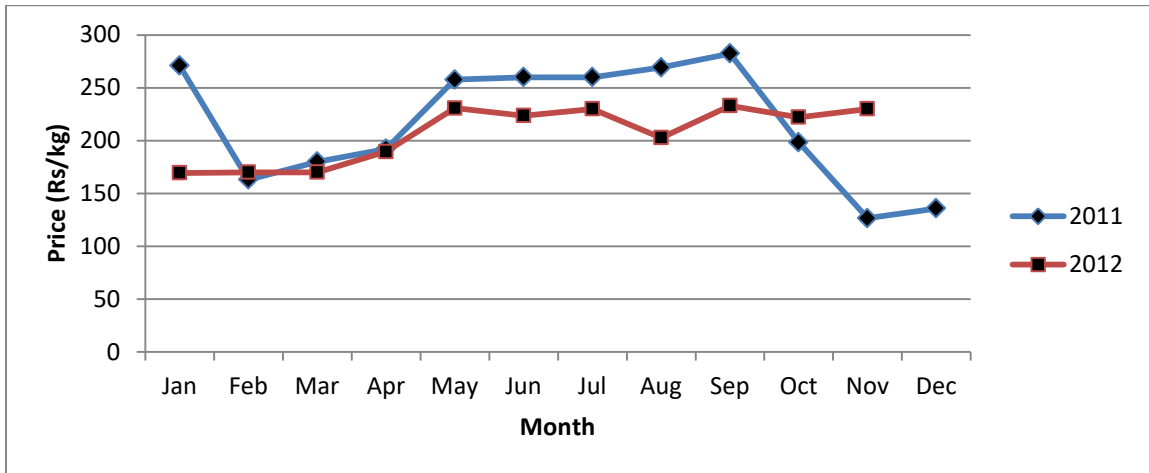

Monthly Average Producer Prices of Yellow Zucchini

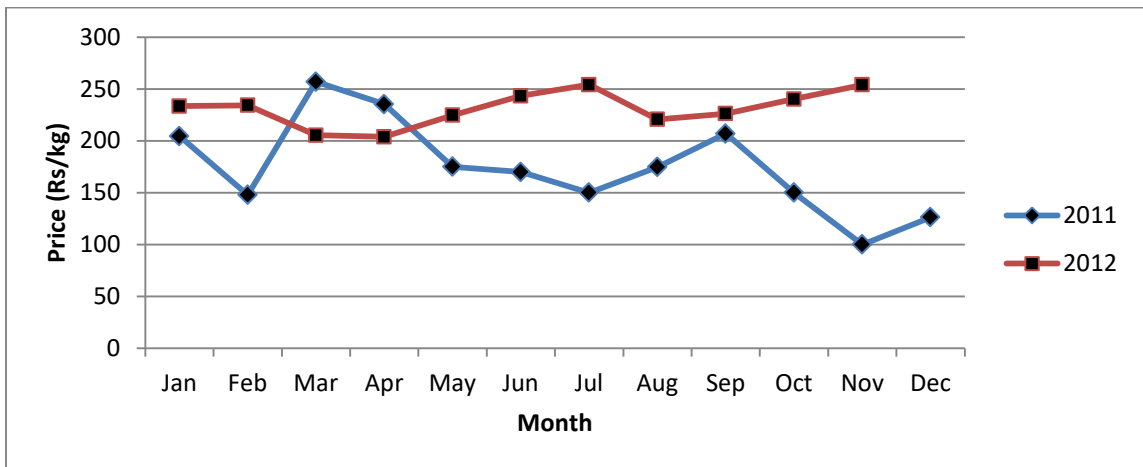

Monthly Average Producer Prices of Green Zucchini

Source: Agricultural Cooperative Society Ltd. & Economic Centre at NuwaraEliya

Annex 7: Producer Price Ranges of High Value Highly Perishable Vegetables in Nuwara Eliya -2012

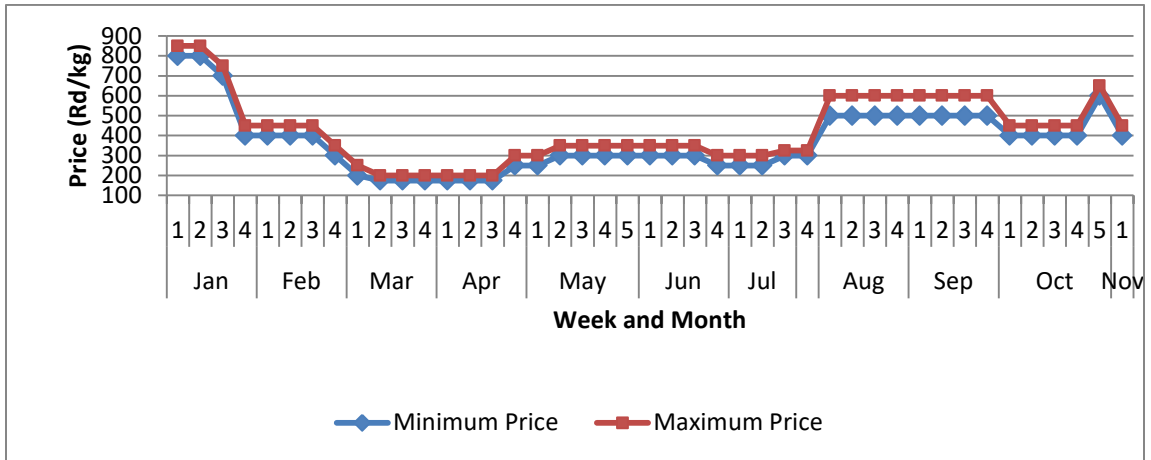

Producer Price Range of Bell Pepper Red

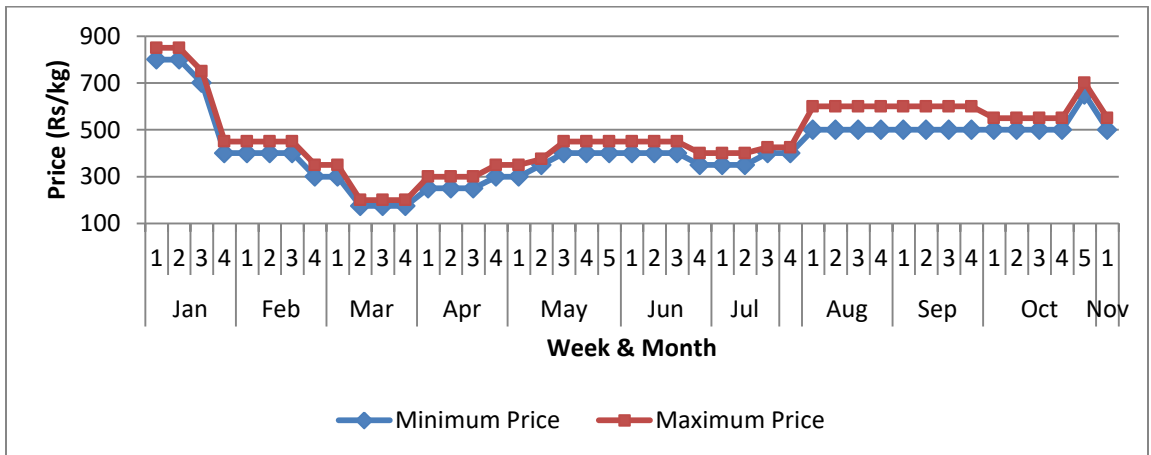

Producer Price Range of Bell Pepper -Yellow

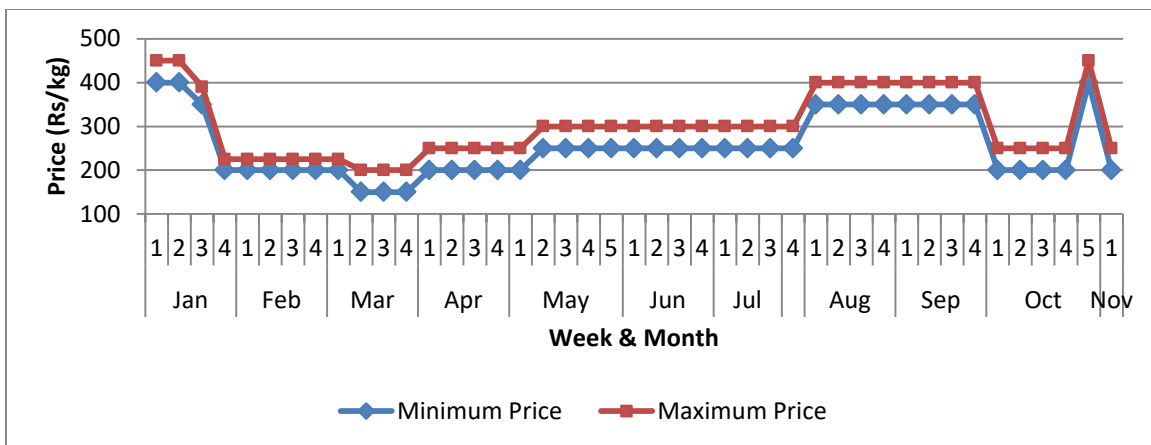

Producer Price Range of Bell Pepper Green

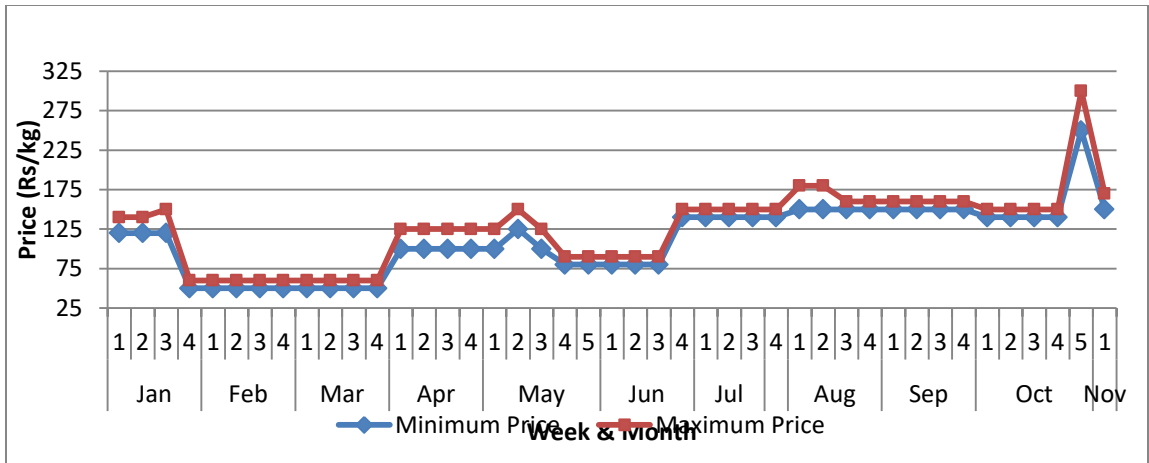

Producer Price Range of Zucchini Green

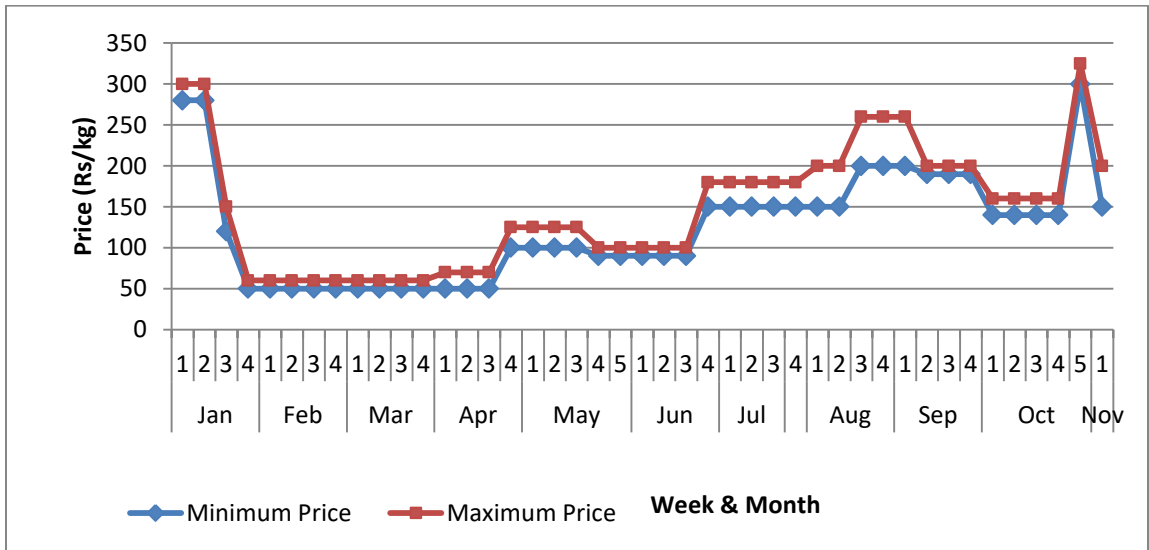

Producer Price Range of Zucchini - Yellow

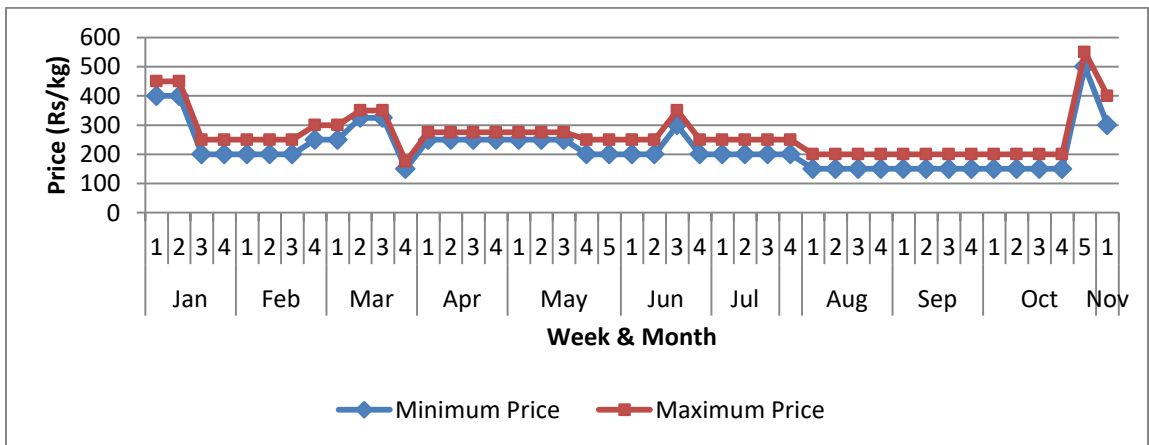

Producer Price Range of Broccoli

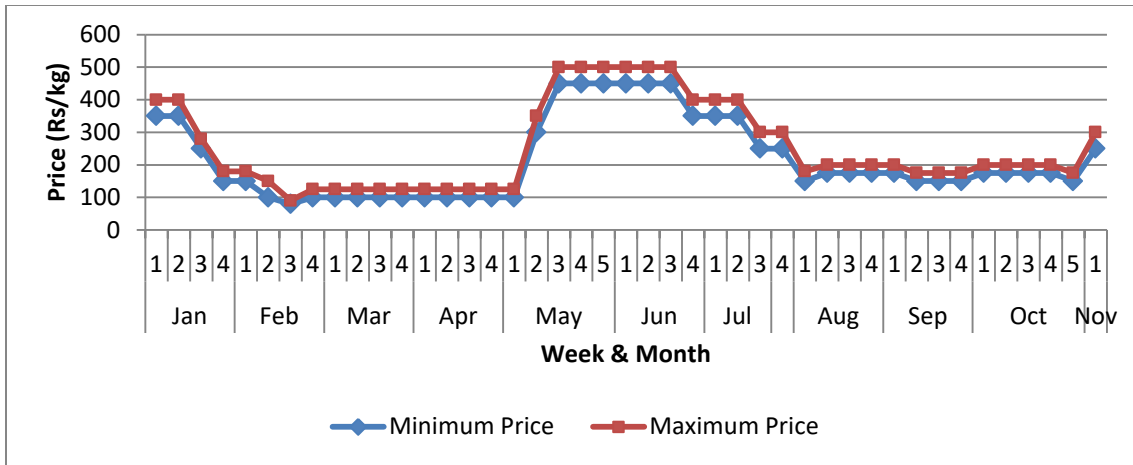

Producer Price Range of Iceberg

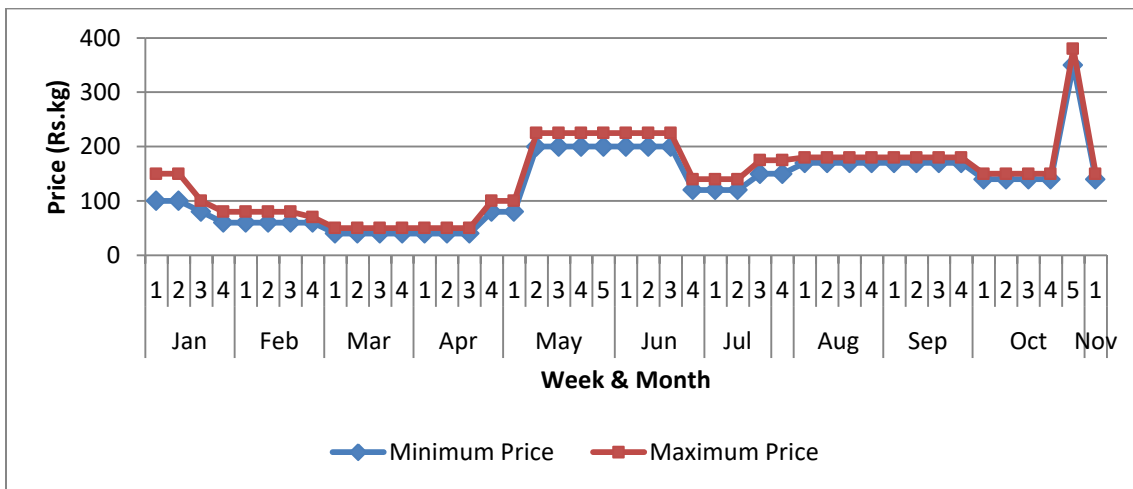

Producer Price Range of Lettuce - Red

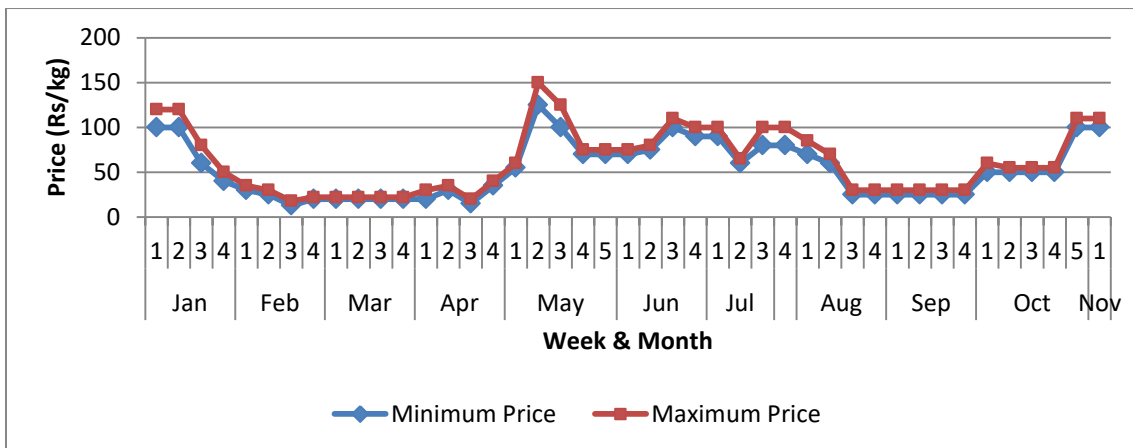

Producer Price Range of Lettuce - Green

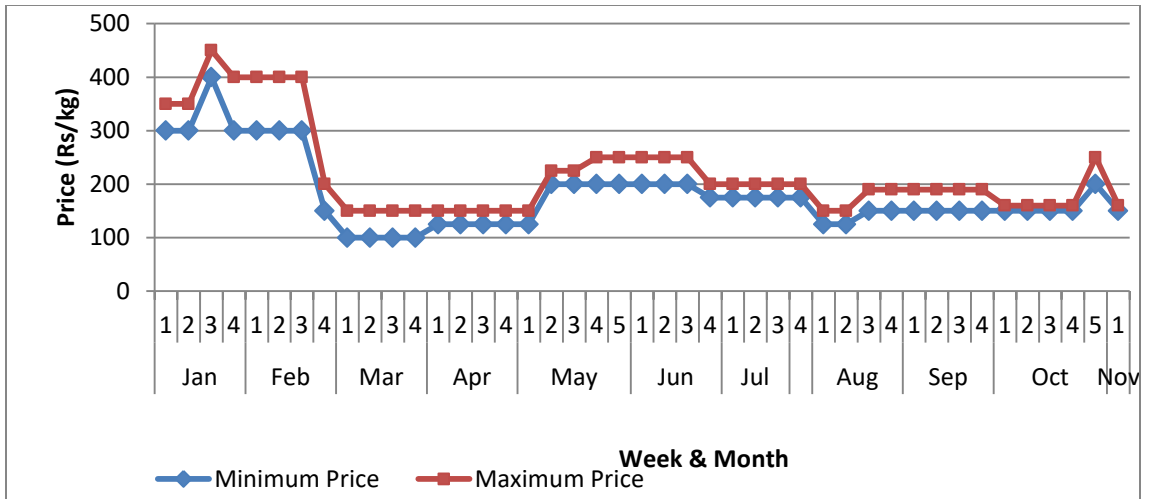

Producer Price Range of Red Cabbage

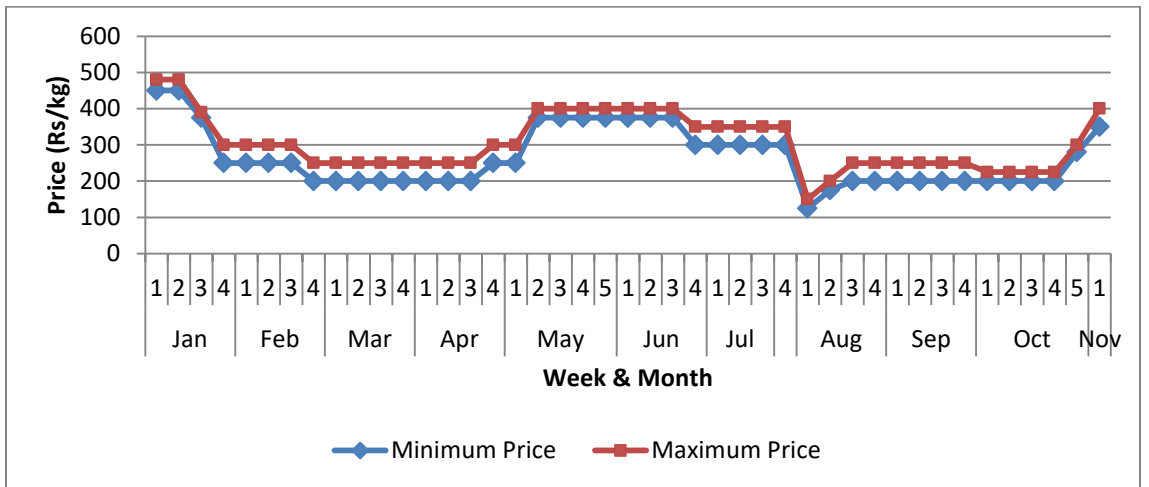

Producer Price Range of Cauliflower

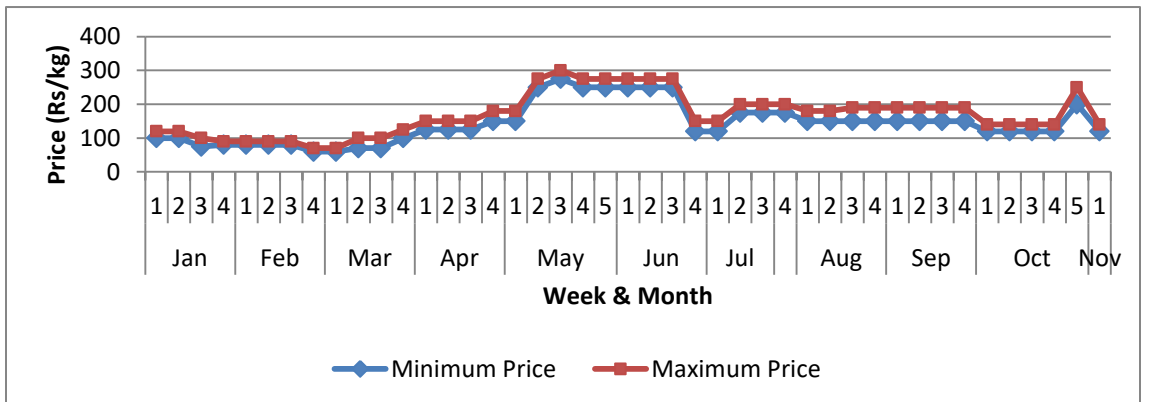

Producer Price Range of Chinese Cabbage

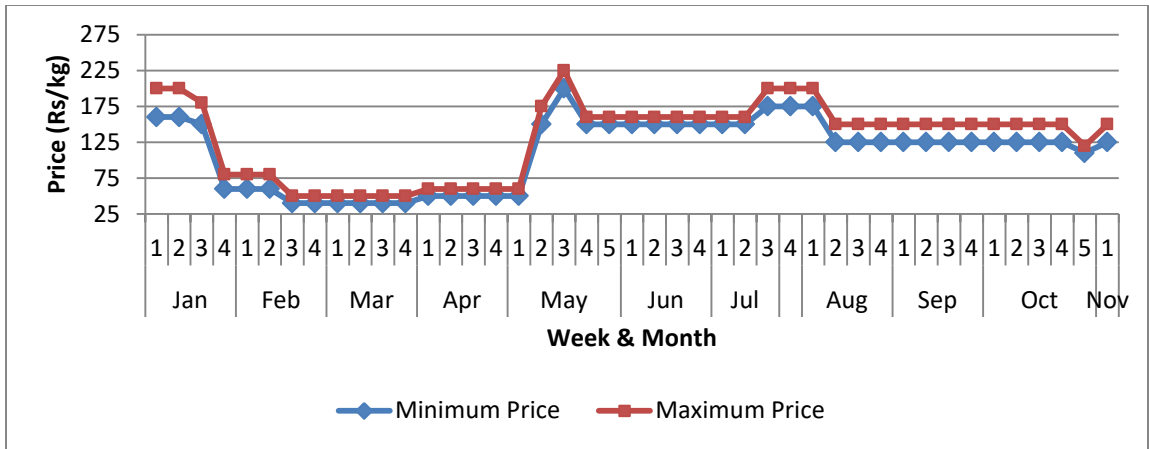

Producer Price Range of Tomato in Poly Tunnel

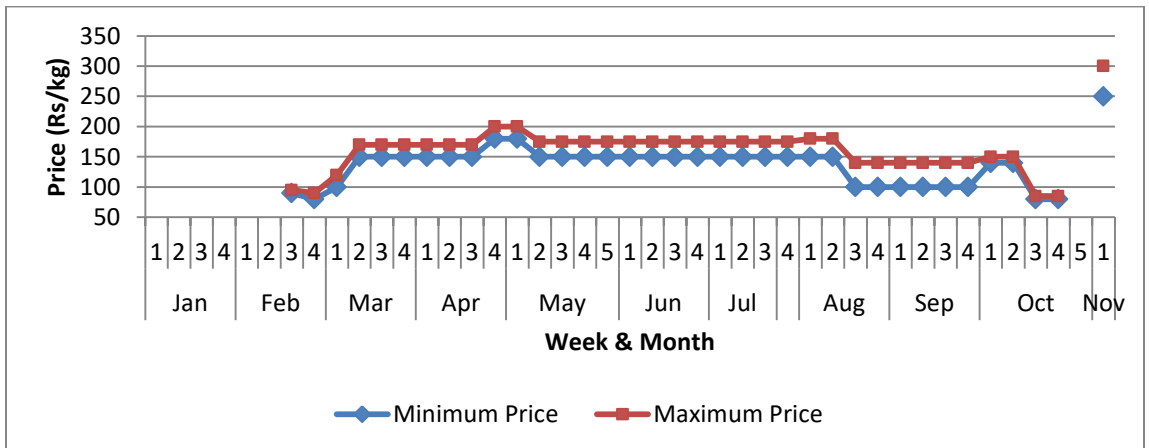

Producer Price Range of Cucumber - Green

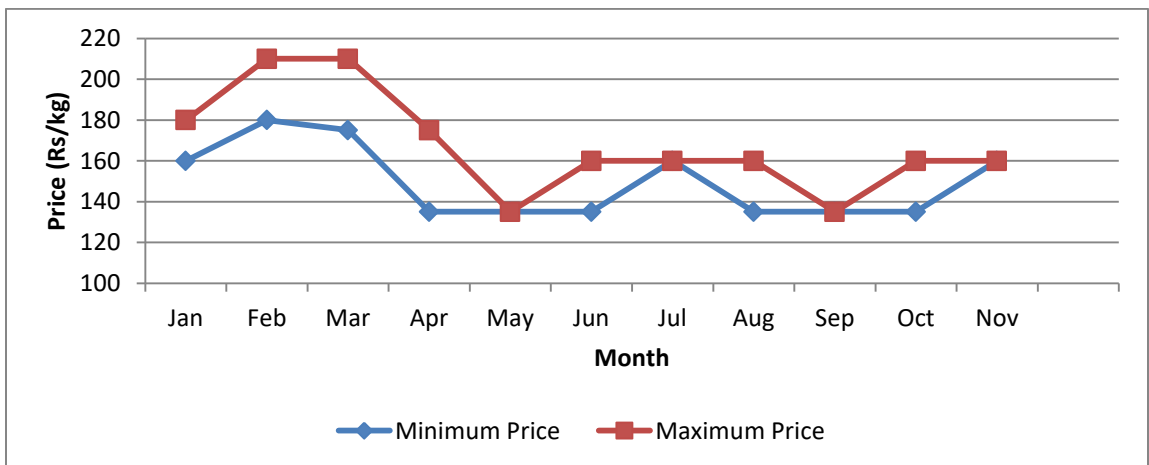

Producer Price Range of Pak Choy

Annex 8: Daily Purchases of High Value Highly Perishable Vegetables of UPEPV

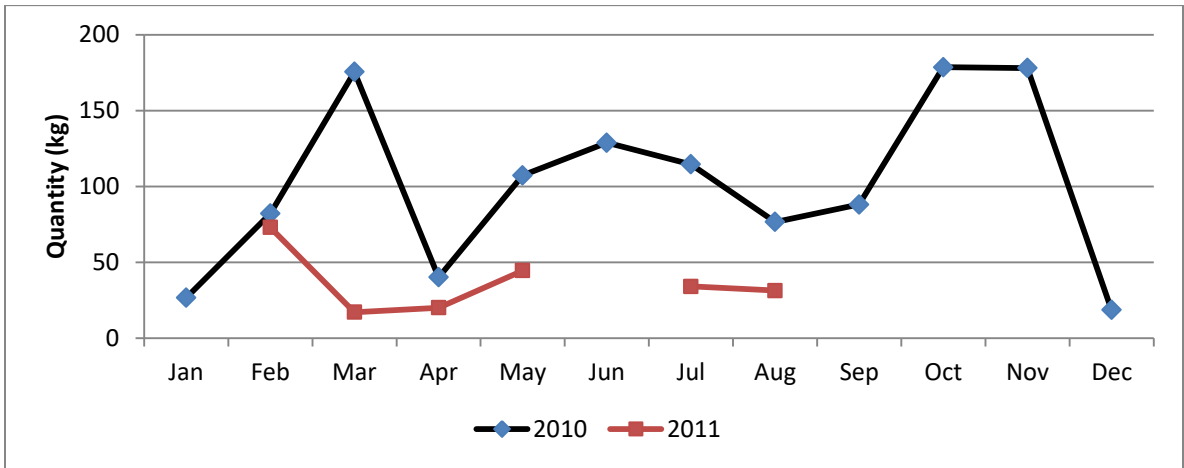

Monthly Average Daily Purchases of Celery (Kg/day)

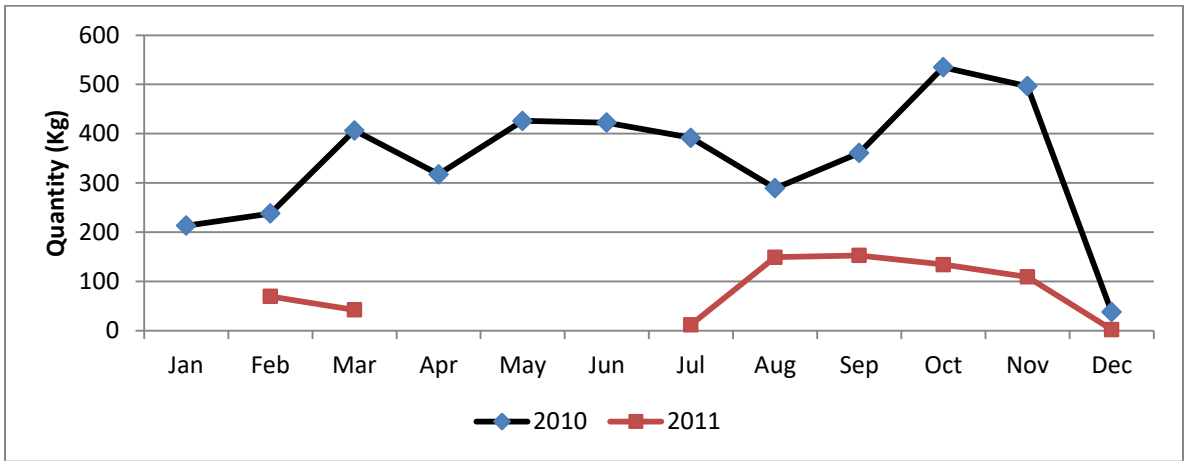

Average Daily Purchases of Chinese Cabbage per Month (Kg/day)

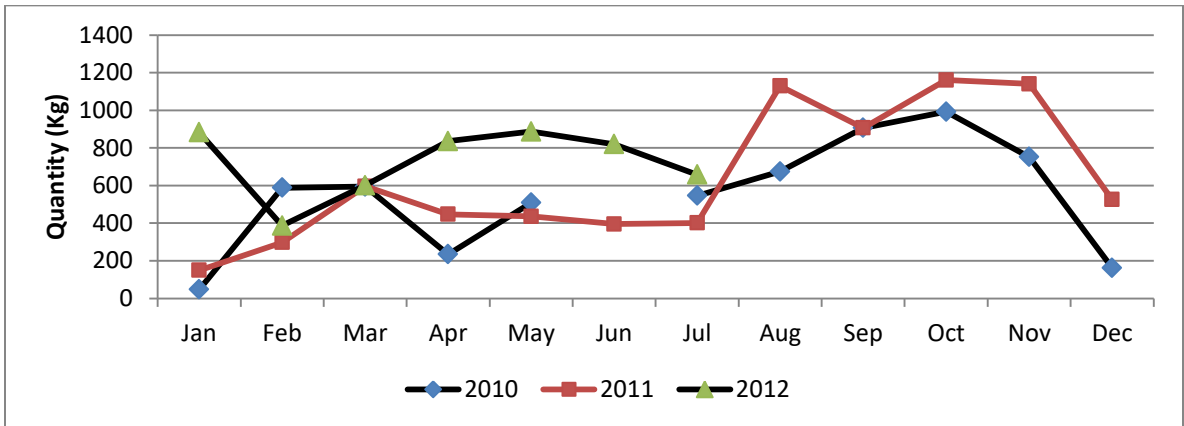

Average Daily Purchases of Cucumber- Green per Month (Kg/day)

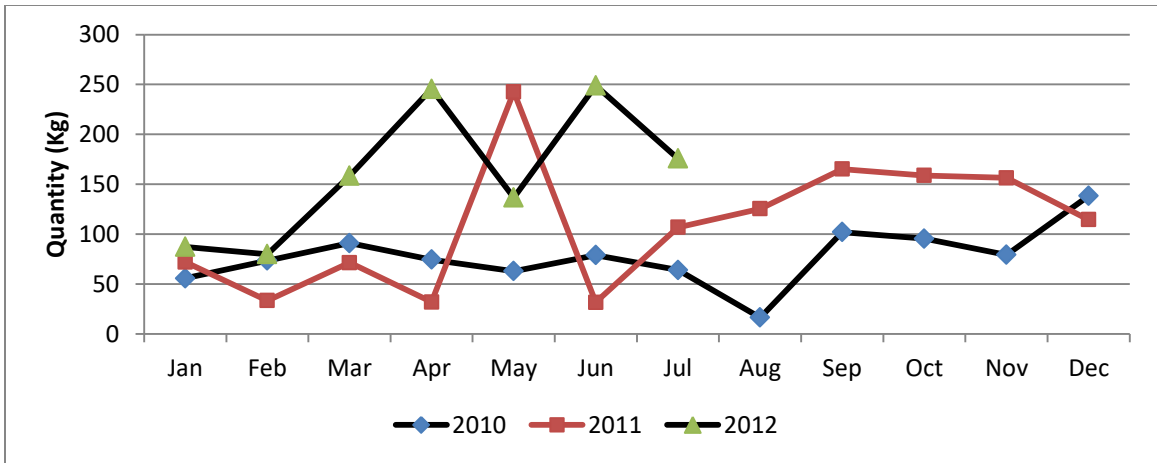

Average Daily Purchases of Bell Pepper- Grade II per Month (Kg/day)

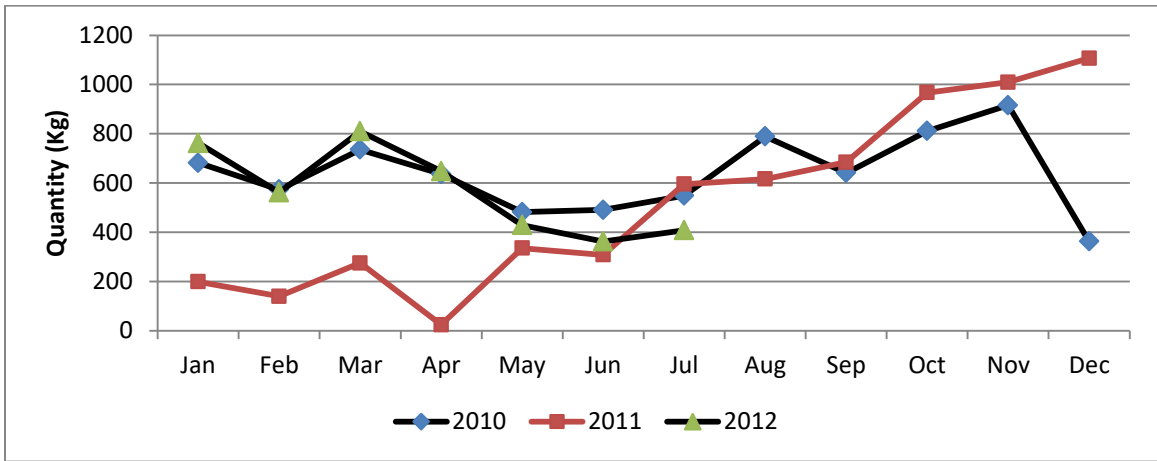

Average Daily Purchases of Bell Pepper- Green per Month (Kg/day)

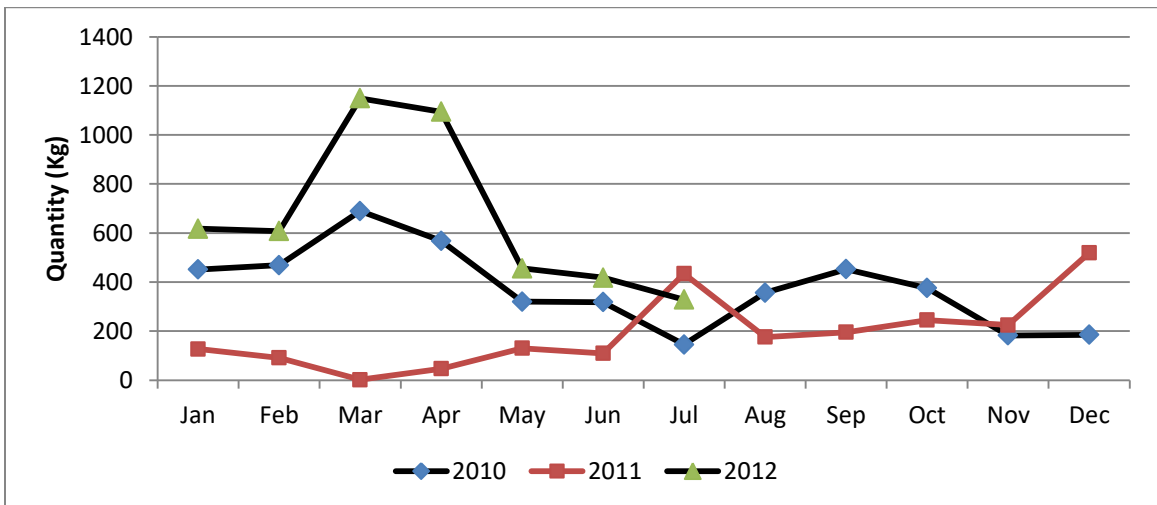

Average Daily Purchases of Bell Pepper- Red per Month (Kg/day)

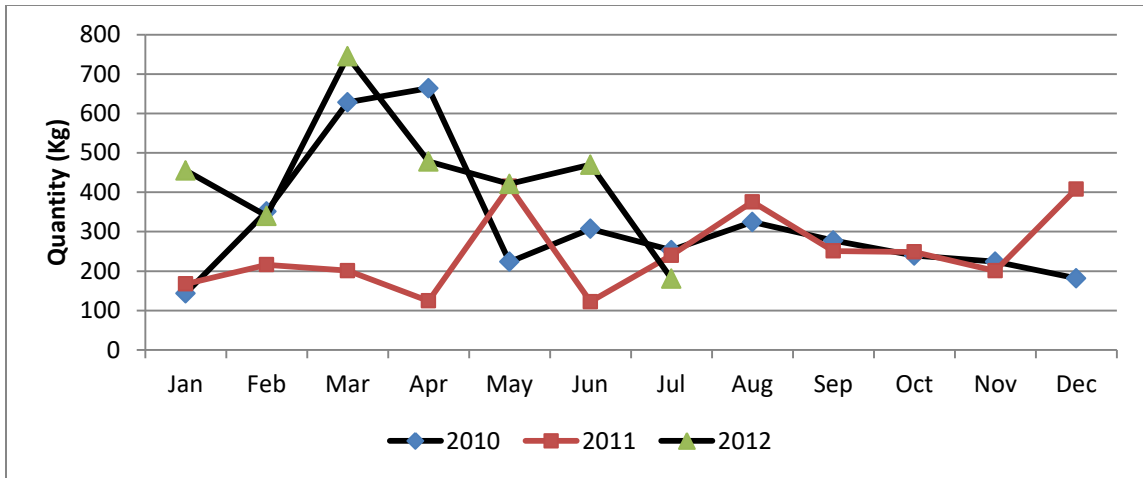

Average Daily Purchases of Bell Pepper- Yellow per Month (Kg/day)

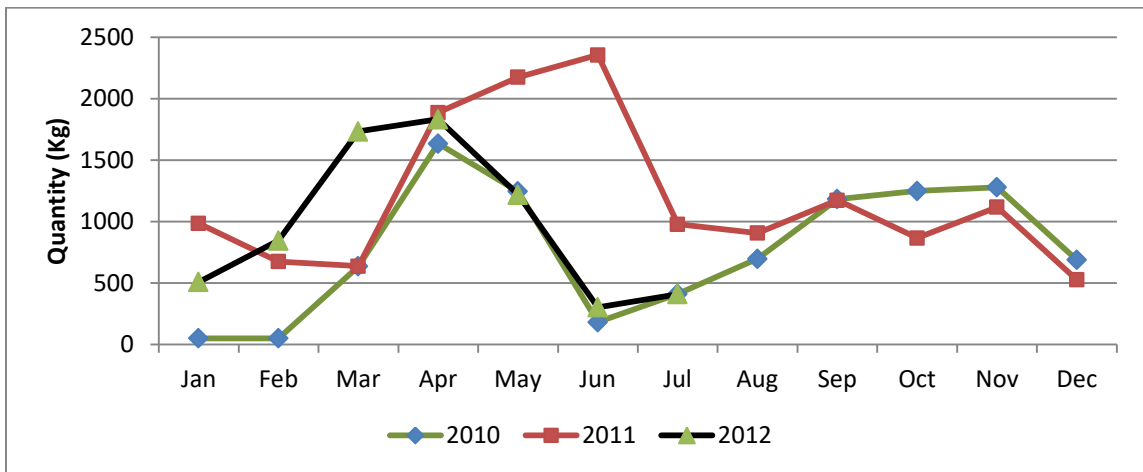

Average Daily Purchases of Tomato PT per Month (Kg/day)

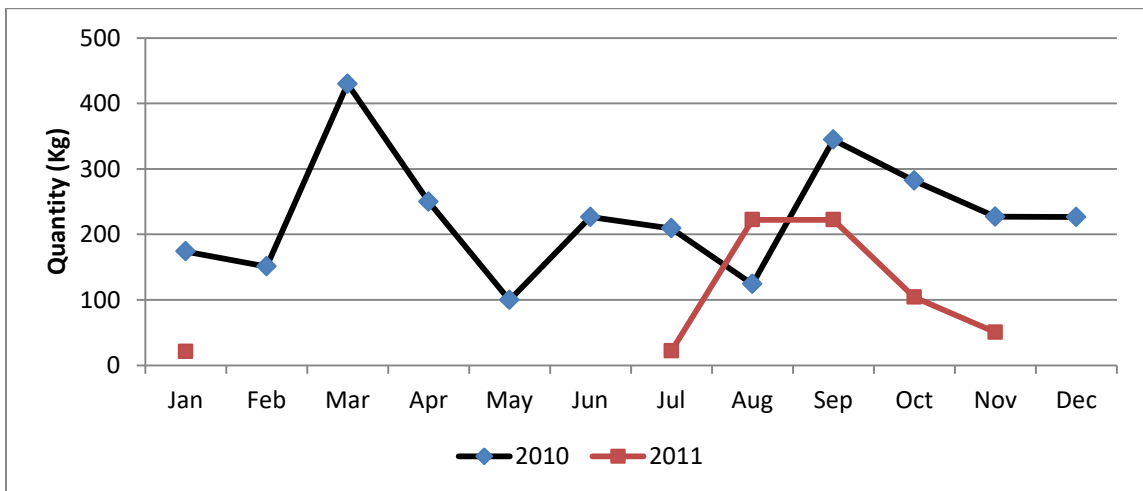

Average Daily Purchases of Iceberg per Month (Kg/day)

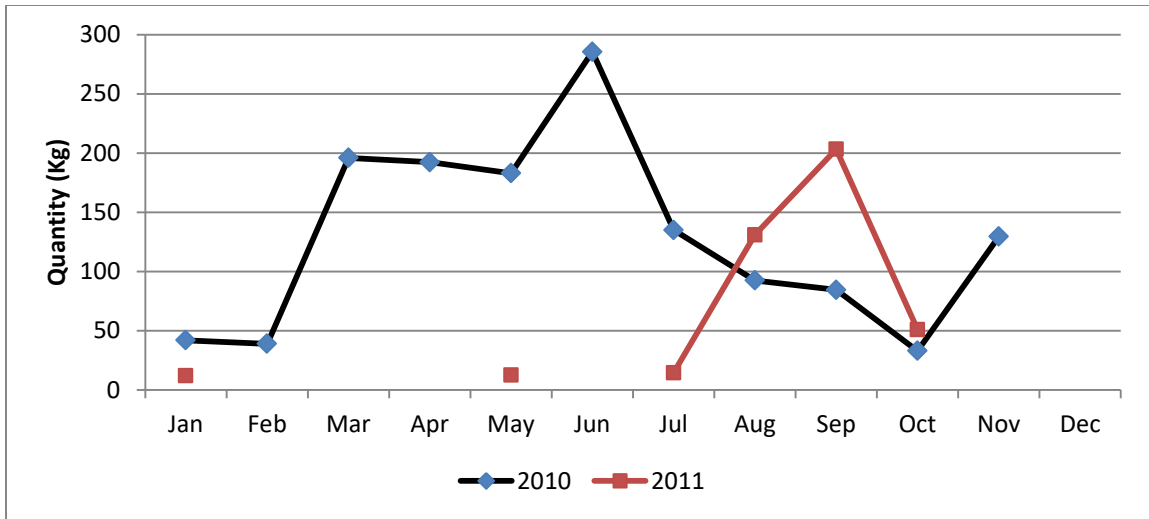

Average Daily Purchases of Pak Choy per Month (Kg/day)

Source: Uva Paranagama Export Production Village (UPEPV)

Annex 9: Price Spread of High Value Highly Perishable Vegetables

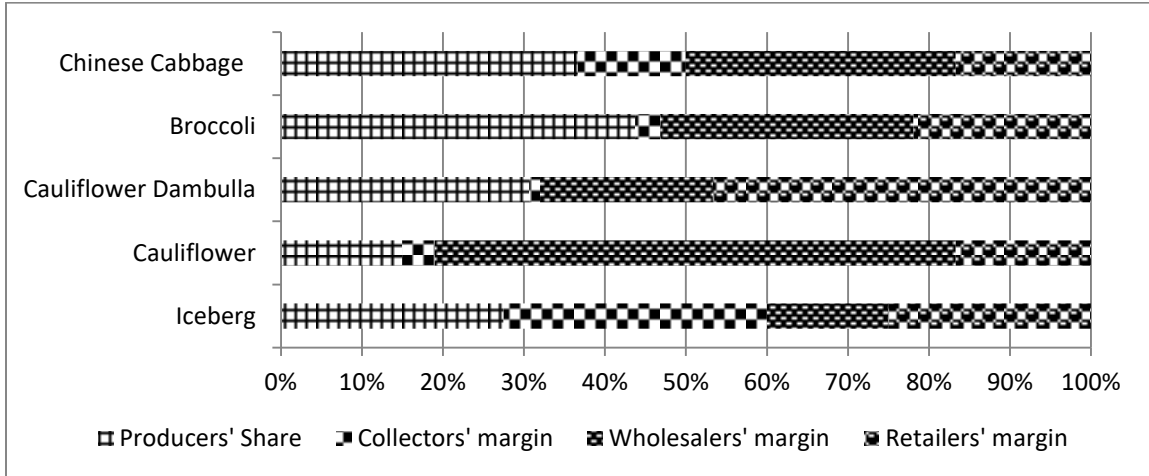

Price Spread of Chinese Cabbage, Broccoli, Cauliflower and Iceberg

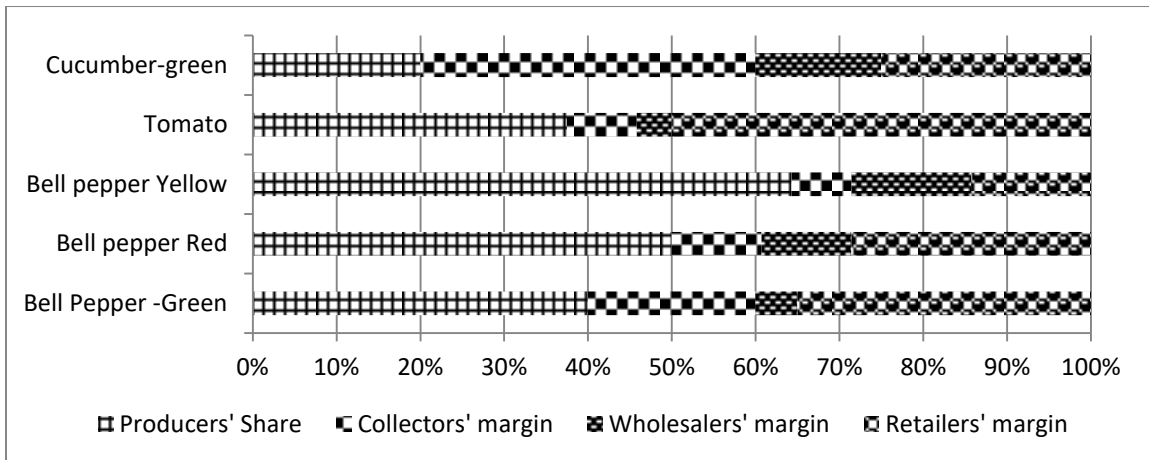

Price Spread of Green Cucumber, Tomato & bell pepper

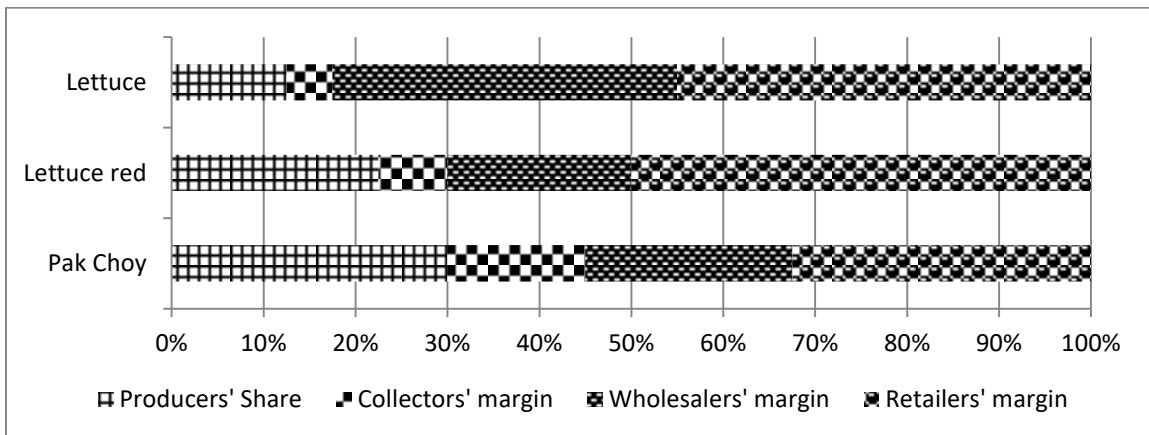

Price Spread of Lettuce & Pak Choy