



**HARTI**  
**Hector Kobbekaduwa**  
**Agrarian Research and**  
**Training Institute**



## **VALUE CHAIN ANALYSIS OF THE MILK INDUSTRY IN SRI LANKA**



**SAGARIKA HITIHAMU**  
**M.D. SUSILA LURDU**  
**B.A.D.S. BAMUNUARACHCHI**



# **Value Chain Analysis of the Milk Industry in Sri Lanka**

**Sagarika Hitihamu  
M.D. Susila Lurdu  
B.A.D.S. Bamunuarachchi**

Research Report No: 237

March 2021

**Hector Kobbekaduwa Agrarian Research and Training Institute  
114, Wijerama Mawatha  
Colombo 7  
Sri Lanka**

© 2021, Hector Kobbekaduwa Agrarian Research and Training Institute

First Published: March 2021

ISBN: 978-955-612-269-5

National Library and Documentation Services Board - Cataloguing-In- Publication Data

Hitihamu, Sagarika

Value Chain Analysis of the Milk Industry in Sri Lanka / Sagarika Hitihamu, M.D. Suksila Lurdu and B.A.D.S. Bamunuarachchi - Colombo: Hector Kobbekaduwa Agrarian Research and Training Institute, 2021. -

x,82p.; 30 cm. (Reserch Report: No. 237)

ISBN 978-955-612-269-5

i. 338.1771095493 DDC23

ii. Lurdu, M.D. Susila (Co-author)

iii. Bamuknuarachchi, B.A.D.S. (Co-author)

iv. Series

1. Milk trade - Sri Lanka

2. Dairy Products Industry - Sri Lanka

Hector Kobbekaduwa Agrarab Rsearch and Training Institute  
114, Wijerama Mawatha, Colombo 07  
Sri Lanka

Final typesetting and lay-out by: Dilanthi Hewavitharana

Tel. Phone : +94112696981  
: +94112696437

Fax : +94112692423

Email : [librarian@harti.gov.lk](mailto:librarian@harti.gov.lk)

Web page : [www.harti.gov.lk](http://www.harti.gov.lk)

## **FOREWORD**

Dairy development is an important element in drives to improve the rural economy and lift the nutritional standards of the nation. It is no secret that Sri Lanka has been spending enormous amounts to import milk and milk based products. Indeed, this import dependency is in part the result of policy decision that have had a crippling effect on the local dairy industry. It is in this context that value chain analyses of the dairy industry can help unravel complexities and yield suggestions that can have a positive effect on stakeholders as well as the nation, in economic terms as well as delivering nutritional requirements.

This study was launched with the objective of identifying value chains, relevant actors and gaps, assessing efficiencies as well as the impetus or limitations of the existing policy environment. Within these broad areas of course reside the details, the examination of which demonstrate a complex matrix of operations which indicate that addressing gaps is no easy task.

Nevertheless, it is always good to let knowledge be the foundation on which the edifice of response is built. This study certainly puts important building blocks in place.

**Malinda Senaviratne**  
**CEO / Director**

## **ACKNOWLEDGEMENTS**

I wish to express my sincere gratitude to Mr. Malinda Senavirathna, Director, CEO HARTI for his support in publishing this report.

I also extend my sincere thanks to Senior Professor Ranjith Premalal de Silva and Dr. Keerthi Kotagama, former Directors, HARTI for their guidance and support throughout the research study.

I would like to pay my gratitude to Dr Fredric Aberathne, Consultant, Agriculture Economist, Visiting Lecturer, PIM, University of Jayawardenapura, Former Deputy Director (Rtd) Head, Poverty-Governance Units, UNDP and Dr. Frank Niranjana, Deputy Director, Council for Agriculture Research Policy, for providing valuable comments to improve this research study.

Dr. Ranjith Wickramasinghe, Additional Director Research (Acting) deserves a special word of appreciation for his excellent support and encouragement throughout.

I would also like to convey my sincere thanks to Ms. Sandya Senanayake, former Senior Statistician, Ms. Imasha de Silva, Mr. Kasun Indraprabath, Statistical Assistants of APPE division for their continued support and dedication towards completing the field work, data collecting, data analysis and all other support given to complete this task successfully.

I would prefer to convey my sincere gratitude to the Provincial Directors of Central, Southern, Northern, North Central, North Western and Western Provinces for their excellent support given to facilitate data collection. In addition, I convey special thanks to all district Veterinary Surgeons of Nuwara-Eliya, Kandy, Gampaha, Jaffna, Kurunagala, Anuradhapura and Hambantota districts. Further, field level Livestock Development officers of the respective areas deserve a special word of appreciation for their assistance in field survey.

I would also like to thank all the milk collectors in the study area for providing details of milk collection and other required information for this study.

All small scale, medium scale and large scale farmers, private collectors, processors and all the stakeholders who provided data for the study are also appreciated.

I would like to offer special thanks to Mr. S.A.C.U Senanayake and other staff members of the Publication Unit of HARTI for their support to publish this report. Further, I extend my gratitude to Ms. Suharshi Perera for her excellent editorial support. I would also like to thank Ms. Udeni Karunaratne for cover page designing and other support given during the publishing process.

I would like to appreciate Ms. D.A.A. L Weerapala and Ms.Lahiluka Rasmini for typesetting the report. Finally, I thank all the staff members of the Agricultural Policy and Project Evaluation Division in helping me complete this task successfully.

**Sagarika Hitihamu**  
**Senior Research Officer**

## Executive Summary

Dairy development is significant for the rural economy of Sri Lanka due to its potential in generating income and employment opportunities. Dairy products provide high quality protein, minerals and vitamins to the population. The DAPH estimates that the domestic milk production can only meet 40 percent of the national requirement and annually Sri Lanka spends a staggering sum on importation of milk and milk based products.

Even though dairy industry provides substantial benefits, farmers are leaving the industry due to various reasons. Consequently, their livelihood is at risk due to various natural and artificial factors. Therefore, a study on value chain analysis of dairy industry in Sri Lanka is timely and important. Further it will help to understand different value additions and relevant value chains, which will be beneficial in identifying most efficient value chains and increase competition.

This study on value chain analysis of dairy industry mainly focused on identifying value chain actors in existing value chains and assessing the efficiency of resource utilization. The specific objective is to map existing value chains of dairy industry in Sri Lanka, to assess efficiency of actors involved in primary and support activities of dairy value chain, to analyze the existing policy environment for the milk and milk products sub sector development and to identify problems and potentials of dairy industry in Sri Lanka to suggest policy improvements.

In line with the objectives a mixed research method was applied and data collection consisted of literature review, focus group and key informant discussion, questionnaire survey and direct interviews.

The questionnaire survey was conducted to represent dominant dairy farming systems, such as up country, mid country, low country wet, low country dry, the Coconut Triangle and the Jaffna peninsula. In order to represent the above farming systems Nuwara - Eliya, Kandy, Gampaha, Anuradhapura, Kurunagala and Jaffna districts were selected respectively. Milking farmers and processors were interviewed with pre-tested structured questionnaires. Thirty farmers from each district were selected randomly and 180 farmers were interviewed to gather information. In addition, 38 processors and 12 farmers and processors were interviewed; the total sample population consisted of 230 dairy sector stakeholders.

Porter's Value Chain Concept was utilized to understand the value chain performances and gaps. Accordingly, in Sri Lanka there are several value chains in operation. The most common value chain is farmers producing milk in their farms and selling the raw milk to collectors. It can be identified under Porter's primary activities and farmers only complete in-bound logistics and operations. Within these two categories farmers obtain inputs needed for milk production and they transform input into raw milk under primary activities, out-bound logistics, marketing and sales and customer service are performed by milk collectors. Under the support activities, the government, private and non-government sectors are responsible for

providing services such as infrastructure development, human resource management, technology development and procurement of resources.

The research findings indicate that around half of the farmers are in the 30-50 age group and young farmer contribution was around seven percent. Further around 55 percent of the sample owned less than half an acre for farming activities. However, 85 percent of the sample have 5-20 years dairy farming experience. It was noted that 85 percent of the farmers have education from secondary to graduate level. The average income of dairy industry was Rs. 39,290 per month.

The study reveals that 58 percent of the farmers practice semi intensive farming, 26 percent intensive farming and only 16 percent of the farmers practice extensive management. Jersey breed contributed 53 percent of the cattle population in the study area where as Frisian and Sahiwal constitute 17 and 12 percent respectively.

The study found that Frisian, AFS, Jersey and crosses of Jersey Frisian and Jersey Sahiwal produces more than eight liters per day. An average herd size comprised 5.4 animals and 44 percent of the sample constituted less than five animals in a herd.

The main value chain actors in the input market are feed supply, water supply, labour availability, veterinary services, animal breeding and other inputs. In the output market milk collectors play a major role in collecting, transporting, processing and distributing the products. Milco is the foremost milk collector followed by Nestlé, YALCO, LIBCO, CIC Dairies, Palawaththa, Cargills, Rich Life and other private collectors. In the input market farmers are required to maintain own grassland due to land limitations and farmers largely rely on low quality road side grasses.

Further, the study found that due to high prices of concentrate feed, farmers are unable to provide correct amount of concentrate feed. The institutional support received from the government sector and animal health and breeding seems to cover the focused areas. However, a production oriented extension service needs to be developed and 24 hour- on- call veterinary service units are requested by farmers. Promotion of liquid milk and door- to- door milk marketing system should be introduced and it is essential to limit the powdered milk imports to develop the local dairy sector. Cost of production with and without family labour was calculated as Rs. 59.63 and Rs. 29.73 respectively.

Curd, yoghurt, ice cream, milk toffee production was identified with high potential value added products. However, ice cream production yields the highest return. In the context where dairy farming is the sole income activity of the family, 14 dairy cows are needed to be reared in different lactation stages to obtain a mean household income of Rs 62,237 a month. The Cobb-Douglas Production Function shows that labour, concentrate feed, cost of veterinary and medicine and fixed cost affect milk production significantly.

The study concludes that milk production and value added dairy products are profitable ventures. However, the primary activities such as feed provision and other input provision need be developed. Further, small scale dairy farm units need to be transform in to economic units.

## LIST OF CONTENTS

	<b>Page No.</b>
FOREWORD	i
ACKNOWLEDGEMENT	ii
EXECUTIVE SUMMARY	iii
LIST OF CONTENTS	vi
LIST OF TABLES	viii
LIST OF FIGURES	ix
ABBREVIATIONS	
<b>CHAPTER ONE</b>	
<b>Introduction</b>	<b>1</b>
1.1 Background	1
1.2 What Is Value Chain?	1
1.3 Relevance of the Study	2
1.4 Problem Statement	2
1.5 Objectives	3
<b>CHAPTER TWO</b>	
<b>Literature Review</b>	<b>5</b>
2.1 Value Chain Concept	5
2.2 Definitions of Terms	6
2.3 History of Value Chains	8
2.4 Importance of Value Chain Analysis (VCA)	8
2.5 Importance of Agricultural Value Chains in Developing Countries	8
2.6 Conceptual Framework	9
<b>CHAPTER THREE</b>	
<b>Methodology</b>	<b>11</b>
3.1 Study Location	13
3.2 Questionnaire Survey	14
<b>CHAPTER FOUR</b>	
<b>Socio-economic Standards of Fairy Farmers</b>	<b>15</b>
4.1 Introduction	15
4.2 Age Distribution of Farmers	15
4.3 Gender Distribution of the Sample Farmers	16
4.4 Main Occupations	16
4.5 Land Availability	16
4.6 Dairy Farming Experience	17
4.7 Reasons for Engaging in Dairy Farming	18
4.8 Income Distribution of the Farmers	19



<b>CHAPTER FIVE</b>		
<b>Characteristics of Dairy Farming</b>		<b>21</b>
5.1	Dairy Management Systems	21
5.2	Cattle Population According to Breed Type	23
5.3	Milk Yield By Breed Type	24
5.4	Herd Size	26
	5.4.1 Herd Composition	27
5.5	Cattle Shed Availability	28
5.6	Cattle Insurance	29
5.7	Record Keeping	29
<b>CHAPTER SIX</b>		
<b>Value Chain Actors</b>		<b>31</b>
6.1	Input Supply	31
6.2	Feed Supply	31
	6.2.1 Size of Grasslands	32
	6.2.2 Concentrate Feed Supply	33
6.3	Water Supply	34
6.4	Labour Supply	35
6.5	Veterinary Services	35
6.6	Animal Breeding	35
6.7	Medicine	37
6.8	Other Inputs	37
6.9	Output Market	37
6.10	Milk Collectors	38
6.11	Milk Colleting Agents	40
<b>CHAPTER SEVEN</b>		
<b>Dairy Development and Policy Issues</b>		<b>47</b>
7.1	Introduction	47
7.2	Institutional Support for Dairy Development	47
7.3	Trade and Tariff Policies	48
7.4	Fiscal and Monitory Policies for Dairy Development	49
7.5	Liquid Milk Pricing Policy	50
7.6	Banning Slaughtering of Cows	50
7.7	Dairy Farmer Insurance Programme	50
7.8	Importation of Dairy Cows	
<b>CHAPTER EIGHT</b>		
<b>Economics of Milk Production</b>		<b>53</b>
8.1	Cost of Production of Milk	53
8.2	Cost of Production of Value Added Products	54
	8.2.1 Curd Production	54
	8.2.2 Yoghurt Production	56
	8.2.3 Ice-Cream Production	57

8.2.4	Milk Toffee	58
8.3	Dairy Farming as an Enterprise	58
8.4	Cobb-Douglas Production Function	59
<b>CHAPTER NINE</b>		
<b>Milk Value Chains of Study Area</b>		61
9.1	Gampaha District	61
9.2	Kandy District	63
9.3	Kurunegala District	64
9.4	Anuradhapura District	65
9.5	Nuwara Eliya	67
9.6	Jaffna District	68
<b>CHAPTER TEN</b>		
<b>Value Chain Gaps and Suggestions for Improvement</b>		69
10.1	Production Sector	69
10.2	Marketing Sector	71
10.3	Milk Processing	71
10.4	Consumers	72
<b>CHAPTER ELEVEN</b>		
<b>Conclusion</b>		<b>75</b>
<b>REFERENCES</b>		76
<b>Annexes</b>		80

## LIST OF TABLES

		<b>Page No.</b>
Table 3.1	Sample Population	14
Table 4.1	Land Availability of Farmers in The Study Area	17
Table 4.2	Education Qualifications of the Sample	18
Table 4.3	Relationship Between Income And Education Levels of the Farmers	18
Table 4.4	Income Distribution of the Farmers (Monthly Average)	19
Table 4.5	Average Monthly Income as a Share in Total Income	19
Table 5.1	Sample Population According to Method of Rearing	22
Table 5.2	Average, Minimum, Maximum Milk Yield by Breed Type	24
Table 5.3	Average Milk Yield per Day per Cow in Different Districts	25
Table 5.4	Recommended Breeds for Different Agro Climatic Zones	26
Table 5.5	Herd Size of the Study Area	27
Table 5.6	Average Herd Composition of the Study Area	27
Table 6.1	Size of Grasslands and Distribution	32
Table 6.2	Milk Collecting Centres And Places of Value Added Products	39
Table 6.3	Number of Milk Collecting Centres in 2018	40
Table 6.4	Cost of Production of Different Products	42
Table 6.5	Cost of Production, Wholesale Price & Retail Price	43
Table 7.1	Veterinary Service Centres in Sri Lanka	48
Table 8.1	Cost of Production With Labour	53
Table 8.2	Cost of Production without Labour	53
Table 8.3	Cost of Production According to Milking Cows	54
Table 8.4	Cost of Production of Curd in Study Area (1 Litre)	54
Table 8.5	Cost of Production of Yoghurt in Study Area (1 Cup)	56
Table 8.6	Cost of Production of Ice-Cream (1 Litre)	57
Table 8.7	Milk Yield as per the Stage of Lactation	58

## LIST OF FIGURES

	<b>Page No.</b>
Figure 4.1 Percentage Age Distribution of Farmers	15
Figure 4.2 Gender Distribution of Dairy Farmers	16
Figure 4.3 Dairy Farming Experience of the Sample Farmers	17
Figure 5.1 Dairy Management Systems	22
Figure 5.2 Distribution of Breeds in the Study Area	23
Figure 5.3 Districts Wise Distribution of Breeds in Different Farming Systems	24
Figure 5.4 Availability of Cattle Sheds in Study Area (%)	28
Figure 5.5 Knowledge on Cattle Insurance	29
Figure 5.6 Insured Animals	29
Figure 6.1 Grass Cultivation by Farmers	31
Figure 6.2 Different Grass Varieties Grown by Farmers	32
Figure 6.3 Available Water Sources in the Study Area	34
Figure 6.4 Breeding Types Practice in Herds	36
Figure 6.5 Farmers Assessment on Service of LDI	37
Figure 6.6 Simplest Value Chain	38
Figure 6.7 Distribution of Milk Among the Collectors in the Study Area	39

## LIST OF ABBREVIATIONS

AFS	Australian Frisian Sahiwal
AI	Artificial Insemination
CIC	Chemical Industries Colombo
CTML	Coconut Triangle Milk Limited
DAPH	Department of Animal Production and Health
DCD	Dicyandiamide
FAO	Food and Agriculture Organization
GPS	Global Positioning System
LDI	Livestock Development Instructor
LIBCO	Livestock Breeders Cooperative
MILCO	Milk Industries of Lanka Company
NADAP	National Association on Drug Abuse Problems
NGO	Non-Government Organization
NLDB	National Livestock Development Board
PLC	Public Limited Company
SNF	Solid Non Fat
UHT	Ultra High Temperature
UNIDO	United Nations Industrial Development Organization
UNDP	United Nations Development Programme
USDA	United States Department of Agriculture
VCA	Value Chain
VS	Veterinary Surgeon

## CHAPTER ONE

### Introduction

#### 1.1 Background

Dairy development is significant in the rural economy of Sri Lanka due to its potential in generation of income and employment opportunities. Milk production has been a traditional industry, which has survived thousands of years playing a key role in infant nutrient and alleviating nutritional poverty among all age groups. It has been a vital source of high quality protein, minerals and vitamins to the population. For many rural smallholder farmers, dairy animals are a 'living bank' that serves as a financial reserve for periods of economic distress. The Department of Animal Production and Health (DAPH) estimates that the domestic milk production was sufficient to meet 40 percent of the milk requirement of the country during 2018, while the rest was met through imported milk powder. The total domestic milk production was estimated as 491.53 million liters in 2020 and 98,837 metric tons of milk powder was imported during 2019. The total import bill accounted for Rs. 55.6 billion in 2019, and it became a huge burden over the years to the economy of Sri Lanka.

According to Perera et al. (2008) dairy industry should develop because it increases food security, reduces rural poverty, reduces import bills and prevents the rural to urban migration. Furthermore, several constraints were identified in developing the Sri Lankan dairy sector including difficulties to access credit facilities, finding the correct breeding stock, difficulties in getting advisory and veterinary service in an effective manner and finding proper markets. Achchuthans & Kajanathan (2012) who conducted a value chain analysis in the Killinochchi district found that majority of the farmers engage in dairy as a small-scale industry to obtain better income; therefore, existing farms should be transformed into large-scale farms. However, the existing knowledge on the dairy industry of the country is not available based on the value chain approach, which yields a better income from the industry.

#### 1.2 What is Value Chain?

A value chain is a full range of activities that include designing, production, marketing and distribution of a product or service from conception to delivery. For companies that produce goods, the value chain starts with the raw materials that are used to make their products and consists of everything added before the product goes to consumers (Harrison, 2019). In contrast to a supply chain, value chain, on the other hand, is a set of activities that focuses on creating or adding value to the product. Value chain analysis is a strategy or tool used to analyse internal firm activities. Its goal is to distinguish which activities are the most valuable to the firm and which ones could be improved to provide competitive advantage. In other words, by looking into internal activities, the analysis reveals where a firm's competitive advantages or disadvantages are. The firm that competes through differentiation advantage will try to perform its activities better than competitors

would do. If it competes through cost advantage, it will try to perform internal activities at lower costs than competitors would do. When a company is capable of producing goods at lower costs than the market price or produce superior products, it earns profits (Jurevicius, 2013).

### **1.3 Relevance of the Study**

Value chain analysis of the dairy industry provides an understanding of dairy markets, their relationships, contribution of different actors such as; input suppliers, producers, farmer organizations, dairy processors, distribution and critical constraints that limit the growth of dairy production and consequently the competitiveness of smallholder farmers. In the prevailing situation, dairy farmers receive only a small fraction of the ultimate value of their output. Value chain analysis can be a useful tool as an industry seeks to achieve competitive advantage. The value chain is a way of conceptualization of the activities that are needed in order to provide a product or service to a customer with increased value. It depicts the way a product gains value (reduced costs) as it moves along the path of design, production, marketing, delivery and service to the customers. According to Perera et al. (2008) dairy production is stagnant due to various constraints in the input supply sector such as the higher price of concentrate, problems in finding correct breeding stock, and constraints to access credit.

### **1.4 Problem Statement**

Even though the dairy industry provides substantial benefits, in general farmers are leaving the industry due to various reasons. Consequently, their livelihood is vulnerable to different natural and artificial shocks. Lack of appropriate marketing channels and limited degree of response from the respective government agents that result in weak market integration are the impediments which affect the livelihood of these communities. Supporting these farmers to engage in different dairy related income generating activities, including marketing and processing of dairy products, could be a means to build their resilience against the shock they are facing. The study on value chain analysis of the milk industry will help understand different value additions and relevant value chains, which will be beneficial in identifying the most efficient value chains in the milk industry to improve the competitiveness of the dairy sector. In addition, from production to consumer, different stages of value chain, how value chain actors and stakeholders contributed to the chain can also be identified to understand the present context, problems and constraints along the value chains. By increasing the efficiency of different dairy value chains, more and more dairy farmers would be able to sustain their dairy farming systems.

According to the “National Research Priorities on Livestock and Poultry 2017-2021” developed by the Council for Agricultural Research and Policy, focusing on manufacturing of cost effective, quality and safer dairy products for consumers with minimum impacts on the environment while maximizing the use of locally available resources and also ensuring the quality and safety of the imported dairy products

are crucial for the development of the dairy sector. Therefore, a detailed dairy value chain analysis will help understand which stage of the chain has to be addressed by the respective parties to increase the production and profitability of the sector. In addition, studying the value chains of the dairy industry will help farmers to decide which value chain they have to adopt to obtain an increased turn over from their enterprise. Moreover, the policymakers will be enabled to utilize the findings of the research for appropriate implementation of new projects and programmes to empower both the dairy producer and the consumer. Therefore, this study is timely and relevant.

### **1.5 Objectives**

The overall objective is to identify actors in existing value chains of the dairy industry and to assess efficiency of resource utilization by actors in each existing value chain.

Specific objectives of this study are:

1. To map existing value chains of dairy industry of Sri Lanka
2. To assess efficiency of actors involved in primary and support activities of dairy value chains
3. To analyse the existing policy environment for the development of milk and milk products sub-sector.
4. To identify problems and potentials of dairy industry in Sri Lanka, and to suggest policy improvements.





## CHAPTER TWO

### Literature Review

#### 2.1 Value Chain Concept

The value chain concept can be divided into two main streams of literature: one is based on Porter's Value Chain Model and other is known as Global Value Chains (Debele,2012). The concept of value was incorporated into the framework when researchers started to show where value is captured within a particular industry (Debele,2012). Value chain analyses are very important for understanding how different products flow from the producers to the final consumers. The value chain perspective provides an important means to understand the business-business relationships, mechanism for increasing efficiency and ways to enable a business to increase productivity and add value (J.E. Austin Associates, 2007). Porter (2004) claims that value chain analysis is a basic tool for diagnosis of competitive advantages and finding ways to create and sustain over it. KIT et al., (2006) defines value chains as set linkages between actors who seek to support each other with the objective of increasing effectiveness and competitiveness. According to Jordan et. al (2014) value chains analyse the links and information flows within the chain and reveals the strengths and weaknesses in the process. It also analyses the boundaries between national and international chains, takes buyers' requirements and international standards into consideration.

M. Porter introduced the generic value chain model in (1985). Value chain (VC), represents all the internal activities of a firm engages in to produce goods and services. VC is formed of primary activities that add value to the final product directly and support activities that add value indirectly.

Value chains encompass the full range of activities and services required to bring products or services from its conception to sale in its final market whether local, national, international or global. Value chain includes producers, inputs suppliers, operation, processors, retailers and buyers. They are supported by a range of technical, business and financial service providers. "A Value Chain Analysis is an alliance of enterprises collaborating vertical to achieve a more rewarding position in the market" (Kumara and Rajeev, 2016,). The value chain mainly focuses on the market collaborating strategy, where it emphasized the linkages between production and marketing activities of the products and services in an effective and efficient manner. Vertical alignment is also an important aspect where companies connect one end of the primary activities up to the last end of the supportive activities, at each stage of the products to increase value.

A value chain brings a product or service from conception, through the different phases of production (involving a combination of physical transformation and the input of various producer services), delivery to final customers, and final disposal after use. The chain actors who actually transact a particular product as it moves

through the value chain include input suppliers (e.g. seed suppliers), farmers, traders, processors, transporters, wholesalers, retailers and final consumers.

Sustainable value chains, is a very useful tool in the attempt to understand overall trends of industrial reorganization and to identify change agents and leverage points for policy and technical interventions (UNIDO). It contains all the activities required to bring the final product or service to the final customer. Along the way, many different firms or businesses have their own activities along the supply chain.

Policymakers focus increasingly on the development of agro-industries with emphasis on promoting effective agro-value chains as a means of further expanding the leading role in economic growth and poverty reduction.

Achchuthan & Kajunathan (2012), in a study on milk value chain analysis in the Killinochchi district found that, dairy farmers of the district face financial difficulties and lacking the required knowledge to establish large scale farms. In addition, technical support which required for milk preservation and value addition was also unavailable in the district.

As shown by Tegegne (2017), land holding size, amount of income from sale of livestock and livestock products, the number of local and cross breed milking cows owned, access to market information and service contact frequency of extension, affected significantly the participation decision and level of participation of households in milk market supply. Heckman's two stage model was used to analyse determinants of milk value addition. The results of Heckman first stage regression model showed that volume of milk allocated for home consumption, distance from market/urban centers, volume of milk yield per day and number of children under six affected the participation decision significantly. The results of second stage regression model showed that education level of the household, local breed milking cows owned, land holding size, membership to milk producers' cooperative and family size had a significant impact on the level of participation of milk producer households in milk value addition. Thus, it is suggested to strengthen the participation of smallholder milk producers in milk market supply and processors via capacity improvement and enhance the access to proper technical support service provisions.

## 2.2 Definitions of Terms

**Value added products can** refer to any product that has been subject to additional actions or combined with extra products to raise the overall value of the product (Chait, 2020).

**Value chain mapping:** a value chain analysis systematically maps the actors involved in production, collection, processing, wholesaling, retailing and consumption of a particular product/ products. This mapping assesses the characteristics of actors' profit and cost structure and flow of goods, money and information through the chain Jordaan et. al (2014).

**Chain actors:** These are the chain players who directly deal with the products either through production, processing, trading and consuming. They actually own the products as it passes through their hands in the chain (Jordaan et. al 2014). According to KIT and IIRR (2010), value chain actors include input suppliers, producers, processors, traders and consumers. These are the actors who are commercially engaged in the chain. Chain supporters are the service providers by actors who never directly deal with the product but whose service add value to the product. For instance, banks, microfinance institutions, insurance companies, transporters, brokers and other supporters including NGOs, government agencies, and research centres (KIT and IIRR 2010). The financial services they provide include loans, pre-financing, shareholdings, factoring and leasing arrangements. Financial institutions alone do not provide financial services; for example, an input supplier may give a farmer a loan in the form of fertilizer, in return for repayment plus interest after harvest (KIT and IIRR 2010).

**Value chain development** - The International Labour Organization, Value Chain Development approach looks at market dynamics and relationships between the different actors in the chain with the objective of strengthening the whole market system - enterprises, business relationships, financial networks, supporting functions, rules and norms, and the business environment – in a way that ensures greater benefits for the poor from economic growth and development.

**Formal chain:** Supply chain where actors support each other so that they can increase their efficiency and competitiveness. They strive to satisfy consumer needs so they can increase profits.

**Informal chain:** A set of linkages between actors in a chain, who do not seek to support each other and have no binding relationships either formal or informal apart from when transacting agreements involve exchange of products and money.

**Bargaining power:** Bargaining power is a measure of the capacity of one party to influence another. It is an important topic in negotiation because parties with higher bargaining power are able to leverage their circumstances to strike more desirable deals with others.

All of the parties in an agreement have their own bargaining power, however little or great (Bush, 2016).

**Profitability:** Profitability is ability of a company to use its resources to generate revenues in excess of its expenses. In other words, this is a company's capability of generating profits from its operations.

**Stakeholder:** People who are directly involved in milk value chain. These include actors, chain supporters and chain influencers. Marketing channel: Formally, a marketing channel is a business structure of interdependent organization that reaches from the point of product origin to the consumer with the purpose of moving product to their final consumption.

### **2.3 History of Value Chains**

Value Chain Analysis is a concept that was described and popularized first by Michael Porter in 1985. The value chain is a systematic approach to examining the development of competitive advantage (Porter, 1985). Porter identified primary and support activities that are necessary for products to gain value and attract the best price on the market. Primary activities are functions that are directly concerned with creating and delivering a product whilst support activities are those activities that are not directly involved in production but may increase effectiveness of the product.

### **2.4 Importance of Value Chain Analysis (VCA)**

According to Porter (1990);

- VCA assists farmers decide which activities should be outsourced.
- It also identifies relationships that offer opportunities to create linkages among farmers' intermediaries and buyers.
- VCA approach also enables farmers to understand and appreciate their business strengths and weaknesses.
- Value chain assists milk processors and others actors to understand their strengths and weaknesses.

### **2.5 Importance of Agricultural Value Chains in Developing Countries**

Governments, private sector companies and non-governmental organizations (NGOs) pay a lot of attention to agricultural value chain analysis and implementation (Helin and Meijer, 2006). According to Kanu et. al (2014) governments and donors can use value chain-based strategies to improve agricultural production by smallholder farmers so that the farmers improve their production, generate increased incomes in agricultural production and stimulate Foreign Direct Investment (FDI) programs in agriculture. The value chain analysis (VCA) concept can be used to analyse constraints that affect smallholder farmers from reaching their fullest potential in terms of production (Delgado, 2003). Value chains have also been used as a tool to develop small businesses and financial institutions through linking producers, financial credit institutions, processors and marketers (Shepherd, 2007).

The chain actors who participate in the Agricultural Value Chain (AVC) as a product moves from one stage to another include input suppliers such as smallholder farmers, agro dealers, processors, transporters, wholesalers, retailers and final consumers (Chengappa, 2018 ). Presently, the issue of smallholder participation in AVCs is of paramount importance to legislators and policymakers seeking to improve rural economic growth and poverty reduction. Smallholder farmer contractual arrangements with private sector agricultural companies are now being spearheaded by farmer co-operatives and farmer groups, so as to overcome production and marketing challenges faced by smallholder farmers (Helin and Meijer, 2006).

## 2.6 Conceptual Framework

Michael Porter's concept of value chain analysis will be utilized for this study. Accordingly, the collective activities that are performed to design, produce, market, deliver and support can represent using a value chain.

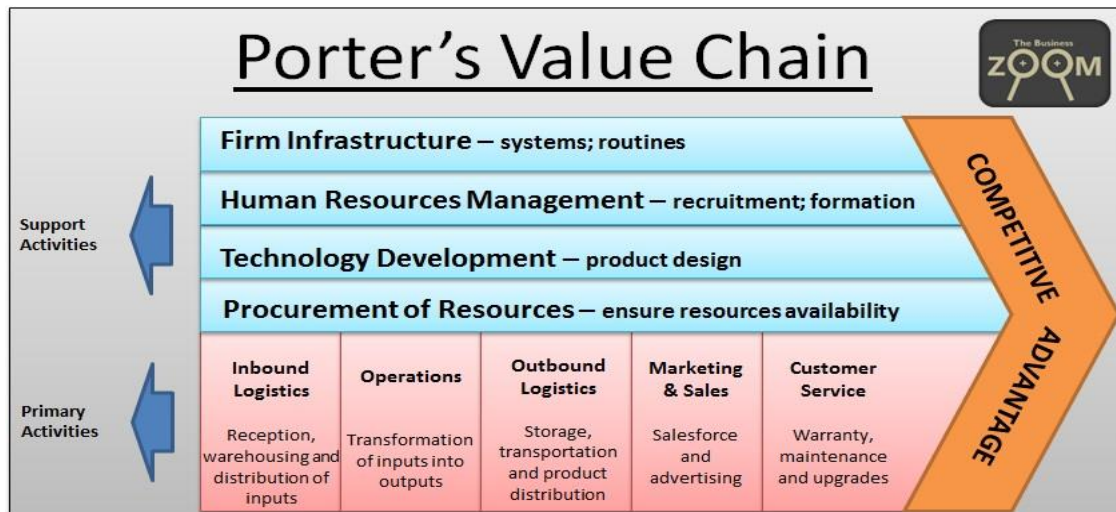

According to Porter's value chain, primary activities in the dairy value chain such as input delivery, processes or operations that input converted to output out-bound logistics, namely storage, transportation and product distribution, marketing and sales, customer services of warranty and maintenance of upgrades need to be analysed in detail. Furthermore, support activities such as farm infrastructure, human resource management, technology development and procurement and resources also need to be discussed to understand the value chain.

The strengthening of agricultural value chains is one of the best ways in addressing problems faced by smallholder farmers. This can be done through improving agricultural production and improving market access and integration of smallholder producers in formal market and viable markets. Research by various scholars has shown the benefits of both production and market-driven approaches (Barrett 2008). ADB (2012) suggests that agriculture can play an important role in economic growth through the increasing smallholder farmers' productivity and income growth. Rural development scholars across the globe are promoting the increased use of the value chain concept for the development of production and market-driven rural development projects and strategies.

Kaplinsky and Morris (2002) define a value chain as the full range of activities that are required to bring a product from the input stage, through different phases of production, transformation and delivery to final consumers. The value chain concept seeks to analyse how production activities are connected in a chain until the final product is produced. The value chain concept also seeks to understand how value creation takes place and shared among the value chain actors (Berg et al., 2009). A

Value Chain Analysis (VCA) for a farmer includes the purchase of inputs, production, marketing and distribution activities to the consumer. The VCA approach also looks at the activities implemented by various actors along the chain and this includes linkages with other actors engaged in activities such as trading, processing and providing business development services such as credit and market information (Berg et al., 2009).

## CHAPTER THREE

### Methodology

In line with the objectives of the study, the method of data collection consisted of three major components: a comprehensive literature review, focus group and key informant discussions, direct interviews and a questionnaire survey.

#### **Objective one - To map existing value chains of dairy industry of Sri Lanka**

To map the existing value chains of the dairy industry in the relevant districts, including the milk collection details, and value added products, small, medium and large scale producers were interviewed using guidelines. A questionnaire survey was also conducted. Data was analysed descriptively and mapping was done.

#### **Objective Two – To examine actors involved in primary and support activities of the dairy value chains**

To study the value chain actors of the dairy industry a questionnaire survey, focus group discussion and interviews were used to collect the required data and information.

According to Porter's Value Chain Analysis, mainly there are primary activities and supportive activities. Primary activities include firm infrastructure, human resource management, technology development and procurement of resources.

Under the firm infrastructure, system of dairy management was considered as an indicator. Especially in Sri Lanka, intensive, semi-intensive and extensive systems of management are applied by dairy farmers, depending on resource availability. Further, under human resources management, farmers' level of awareness was assessed by the number of training programmes they had attended and other extension services offered by the government and non-government sectors were also examined. The resource availability of dairy farming, such as concentrate feed availability, cost, grassland availability grass varieties, water availability, breed types, veterinary and medicine and other support services was also investigated.

The primary activities within the industry can be identified as in-bound logistics, operations, out-bound logistics, marketing and sales and customer services. In the Sri Lankan dairy sector, most of the dairy farmers produce raw milk within their farms and sell to the formal milk collectors. Therefore, according to the Porter's Value Chain Framework, in-bound logistics and operations were undertaken. Indicators such as the concentrate feed price, labour type, labour cost, cost of veterinary and medicine, grassland availability, grass type, breed types, and availability of fixed resources were considered.

In the operation section, the input- output relationship was measured using the Cobb-Douglas Production Function. The relationship of input for the output was



measured using that. Further, how the milk production changes with different inputs were measured.

### **Variables used in the analysis**

Number of animals /herd  
Milk production  
Milk production /breed  
Cost of production/litres of milk  
Total cost/ herd  
Total expenditure  
Profit/ profitability

To measure the input - output relationship in milk production function, Cobb-Douglas production function was used to analyse the input and output relationship in milk production (Vishnoi et al. 2015). It is linear in its logarithmic form and convenient in computer analysis.

The following Cobb-Douglas function (1) fitted to the data in its log-linear form (2)

$$Y=AX_1^{b_1} X_2^{b_2} \dots\dots\dots X_{10}^{b_{10}} e^u \quad (1)$$

$$\ln Y= \ln A+b_1 \ln X_1+b_2 \ln X_2 +\dots\dots\dots b_{10} \ln X_{10}+u \quad (2)$$

Where  $Y$  is the dependent variable and  $X_1\dots\dots\dots X_{10}$  represent the different independent variables and the  $b_1\dots\dots\dots b_{10}$  are the partial elasticities of different independent variables.

#### **Dependent Variable**

$Y$ = Milk production – litres / herd /day

#### **Independent variables**

- $X_1$ - labour man days / herd /day;
- $X_2$ - Concentrate feed = herd/day (kg);
- $X_3$  – Cost of veterinary and medicine (Rs/herd/day);
- $X_6$  – Fixed cost (Rs/Farm/day);
- $X_7$  – Breed type (Pure high, cross, local)
- $X_{10}$  – Management type (intensive, semi-intensive and extensive)

### **Objective Three - To analyse the existing policy environment for the milk and milk products sub-sector**

The existing policy environment of the dairy sector was examined using the secondary data by referring to available secondary information.

## **Objective Four - To identify problems and potentials of the dairy industry in Sri Lanka**

The problems and constraints of the dairy industry value chain were identified using a structured questionnaire, face to face interviews, focus group discussions with the dairy farmers, dairy processors, input suppliers, output distributors and other stakeholders in the dairy industry.

### **3.1 Study Location**

According to Ibrahim et al. (1999), six main cattle and buffalo production systems, which are closely related to different agro climatic conditions of the country; up country, mid country, Coconut Triangle, wet lowlands, dry lowlands and the Jaffna peninsula, were identified. To represent the agro climatic zones as in Table 2.1, six districts have been selected: Up Country - Nuwara- Eliya, Mid Country – Kandy, Low Country Wet- Gampaha, Low Country Dry - Anuradhapura, Coconut Triangle – Kurunegala, Jaffna peninsula- Jaffna. Those districts were selected purposively by considering the availability of dairy farmers. To understand the basic value chain, 180 farmers were selected randomly to represent 30 farmers from each district. In addition, 50 processors were also interviewed to identify other value chain positions in the dairy industry of the respective districts. From the total 50 processors in the sample population 12 farmers are also engaged in dairy farming, therefore the total farmer sample was 192. Furthermore, six curd processors from the Hambantota district are also interviewed using guidelines to understand the curd processing value chain. In addition, three case studies were also performed in Jaffna to gain an in-depth understanding of the dairy production system in the northern part of Sri Lanka. Some of the main milk collectors such as Milco and Nestle were also interviewed to gather information on value addition. The government representatives at district level in the dairy sector and the private sector service providers were also interviewed using guidelines.

**Table 3.1: Sample Population**

<b>Farming System</b>	<b>District</b>	<b>Number of Selected Farmers</b>	<b>Both Farmers and Processors</b>	<b>Number of Processors</b>	<b>Total of Sample Farmers and Processors</b>
Up country	Nuwara-Eliya	30	0	04	34
Mid Country	Kandy	30	0	03	33
Low country wet	Gampaha	30	06	04	40
Low country dry	Anuradhapura	30	0	14	44
Coconut Triangle	Kurunegala	30	06	13	49
Jaffna Peninsula	Jaffna	30	0	0	30
<b>Total</b>		<b>180</b>	<b>12</b>	<b>38</b>	<b>230</b>

Source: Survey Data, 2019

### **3.2 Questionnaire Survey**

For the questionnaire survey 180 farmers were selected according a list of farmers available in the veterinary surgeon's offices of the selected districts. Data collection was performed using the following main themes of dairy farming such as demography of the sample population, dairy management systems, socio-economic standards of dairy farming, herd composition, milk production characteristics, service providers in the milk collection, milk collecting, milk processing, economic viability of dairy farming in different scales of operation.

## CHAPTER FOUR

### Socio-economic Standards of Dairy Farmers

#### 4.1 Introduction

Socio-economic characteristics such as age, gender, education level, occupation, labour, land use, income sources, dairy farming experience, resources availability in dairy farming will be discussed in this chapter. Furthermore, the socio-economic details of dairy farming in the study area will be discussed using samples from different districts.

As discussed in the introductory section, 180 farmers from six districts, 50 processors from the same district and six processors from curd production were interviewed to gather relevant information. The total sample population including farmers and processors comprised 239. The family size ranges from 1-8 members with an average of 3.8.

#### 4.2 Age Distribution of Farmers

Figure 4.1 illustrates the age distribution of dairy farmers in the study area. Accordingly, youth as being categorized as those below 30 years, adults from 30-50 years of age, persons from 50 – 60 years as senior farmers and those above 60 years of age were considered as most senior dairy farmers. As described in the figure, it is clear that approximately half (48.7%) of the farmers belonged to the 30 to 50 age group. In addition, a quarter of the sample farmers was in the 50 to 60 age group and this indicates that 74 percent of the total sample farmers are in the 30 to 60 age group. However, farmers below 30 age group representing seven percent is indicative of the low youth participation in the dairy sector. This suggests dairy farming needs to be restructured as a high income generating industry with timely modifications to attract the youth.

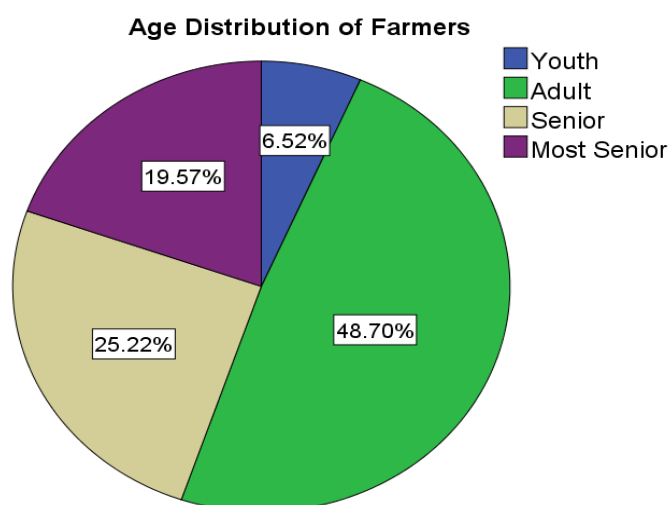

Source: Survey Data, 2019

**Figure 4.1: Percentage Age Distribution of Farmers**

### 4.3 Gender Distribution of the Sample Farmers

Figure 3.2 explains the male - female ratio of the dairy farmers in the study area. Accordingly, 84 percent of the sample comprises males whereas the rest are female farmers.

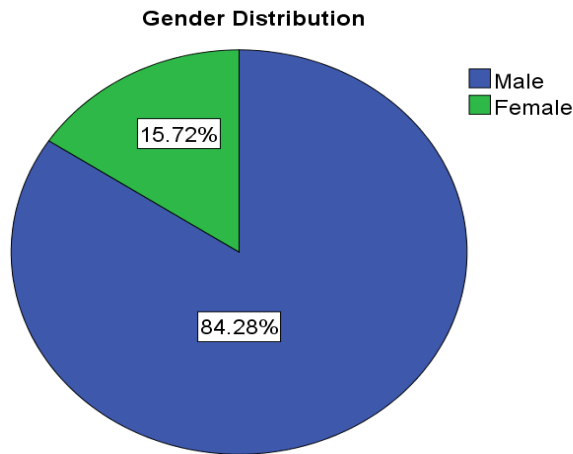

Source: Survey data, 2019

**Figure 4.2: Gender Distribution of Dairy Farmers**

### 4.4 Main Occupations

Main occupation is the main income source of the family. According to the survey data, 94.5 percent of the total sample farmers are engaged in dairy farming as their main occupation. The rest are employed as crop growers, agricultural labourers, non-agricultural labourers, government workers, private sector workers and skilled labourers.

### 4.5 Land Availability

In this study land ownership of the dairy farmers is also investigated. As indicated in Table 4.1, 55 percent of the sample population possess less than half an acre and 11 percent have 0.5 - 1 ac. Around nine percent of the farmers in the sample own 1-1.5 acres whereas 24.5 percent of the dairy farmers own more than two acres.

**Table 4.1: Land Availability of Farmers in The Study Area**

Land Size (Ac)	District- Percentage						Total Percentage
	Gampaha %	Kandy %	Kurunegala %	Anuradhapura %	Nuwara Eliya %	Jaffna %	
0.5>	61.1	60.0	44.4	20.0	90.0	56.7	55.2
0.5-1	11.1	16.7	8.3	20.0	3.3	6.7	10.9
1-1.5	8.3	10.0	5.6	16.7	3.3	13.3	9.4
2<	19.4	13.3	41.7	43.3	3.3	23.3	24.5

Source: Survey Data, 2019

#### 4.6 Dairy Farming Experience

The study revealed that 33 percent of the total sample farmers engaged in dairy farming have more than 20 years of experience and 15 percent having 15 to 20 years of experience. As shown in Figure 4.3, 62 percent have more than 10 years of dairy farming experience. However, 16 percent of the farmers only had less than five years of dairy farming experience. This indicates that majority of the dairy farmers in Sri Lanka engaging in dairy farming have a fair knowledge of dairy farming.

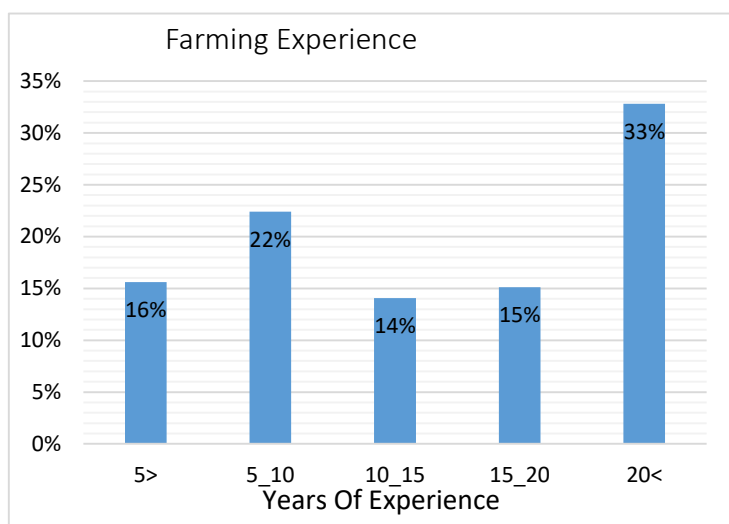

Source: Survey Data, 2020

**Figure 4.3: Dairy Farming Experience of the Sample Farmers**

#### Education Qualifications

Table 4.2 illustrates the education qualifications of the farmers in the study area. Accordingly, 39 percent of the sample have received secondary education which was from grade 6 to GCE O/L, 30 percent of the sample farmers have passed GCE (A/L)

and around 15 percent of the farmers had received only primary education. It should be noted that 2.6 percent had degree level qualifications.

**Table 4.2: Education Qualifications of the Sample**

Education Level	Frequency	Percentage (%)
Primary Education (1-5)	30	15.63
Secondary Education	75	39.06
Passed GCE (O / L)	59	30.73
Up to GCE(A / L)	15	7.81
Passed GCE (A / L)	8	4.17
Graduate	5	2.60

Source: Survey Data

Table 4.3 explains the dairy farmer's education qualifications and their income range. Accordingly, 73 percent of the farmers who received primary education earned less than Rs.25, 000 and only 20 percent of the group received a monthly income of Rs. 25,000 to Rs. 50,000. Farmers who had secondary level of education (51%) gained less than Rs. 25,000 and 48 percent earn Rs. 25,000 to 50,000. Further, four percent of the farmers who gained secondary level of education make more than Rs. 75,000 per month. Farmers who passed GCE (O/L), (42%) of the farmers received less than Rs. 25,000. However, 10 percent of the farmers received more than Rs. 50, 000 incomes. Farmers who studied up to GCE (A/L) half of them earned less than Rs. 25,000 and the rest RS. 25,000 to 50, 000 per month. Further, it is noted that of farmers who passed GCE(A/L), 12.5 percent received less than Rs. 25,000 and 87.5 percent received Rs. 25,000 to 50,000. Forty percent of the graduate farmers earned more than Rs. 75,000 per month. This indicates that a higher percentage of farmers who had better education earned more money compared to those with less education.

**Table 4.3: Relationship between Income and Education Level of the Farmers**

Income (Rs)	Primary Education (1-5) %	Secondary Education (6-11) %	Passed GCE (O/L) %	Up to GCE (A/L) %	Passed GCE (A/L) %	Graduate %
25000>	73	51	42	53	12.5	20
25000-50000	20	45	48	47	87.5	40
50000-75000	7	0	3	0	0	0
75000<	0	4	7	0	0	40

Source: survey Data, 2019

#### 4.7 Reasons for Engaging in Dairy Farming

According to the survey data, a vast majority of the sample farmers engage in dairy farming as their main income source. However, 33 percent of the farmers engage in the industry as a family tradition. In addition, fewer young farmers in the Gampaha and Kurunagala districts had started dairy farming as their main occupation, with

modern management practices and they have proved that dairy farming can be a profitable venture if correct management practices and innovative thinking are incorporated. Another set of farmers had also started dairy farming as an additional source of income generation.

#### 4.8 Income Distribution of the Farmers

**Table 4.4: Income Distribution of the Farmers (Monthly average)**

Income Range (Rs.)	Number of Farmers	Percentage
0-20000	55	28.6
20000-40000	73	38
40000-60000	42	21.8
60000<	22	11.4
Total	192	100

Source: Survey Data, 2019

Table 4.4 describes the income distribution of the sample farmers. Accordingly, monthly income of farmer families ranged from less than Rs. 20,000 to more than Rs. 60,000. The survey proves that the majority of the farmers (38%) receive an income of Rs. 20,000 to Rs. 40,000. In addition, around 22 percent of the farmer families obtain Rs. 40,000 to 60,000. According to the Central Bank Report (2018), an average family of needs Rs. 62,237 per month to fulfil their needs. More than Rs. 60,000 is received only by around 11 percent of the sample population. This indicates that only fewer farmers received a considerable income from this industry. Therefore, it is important to modify the small-scale dairy units in to economic units. Further, to obtain such an income it is important to rear improved breeds.

**Table 4.5: Average Monthly Income as a Share of Total Income**

District	Total Income (Rs)	Milk Income (Rs)	Milk Income Share for Total income (%)
Nuwara Eliya	41930	34440	82%
Kandy	30194	23495	78%
Gampaha	39267	19320	49%
Anuradhapura	55650	28448	51%
Kurunegala	33400	27314	82%
Jaffna	35301	30239	86%
Total Average	39,290	27,209	71.3%

Source: Survey Data, 2019

According to Table 4.5, the average monthly farm family income ranges from Rs. 30,194 to Rs. 55,650. The total average milk income ranges between Rs 19,320 to Rs. 34,440. The total average monthly income is Rs. 39,290.00 whereas the total average milk income is Rs 27,209.00, which is 71.3 percent of the total family income.



However, in the districts such as NuwaraEliya, Kurunagala and Jaffna, farmers receive more than 80 percent of the income from the dairy industry. The districts such as Anuradhapura and Gampaha consist of 50 percent of milk income of the total family income.

In Porter's value chain concept, both primary activities within the firm and support activities are taken into account. Under support activities, human resource development and firm infrastructure development are also key areas. Hence to develop the human resource, it is important to understand the educational background and the farmers' experience in the dairy sector. As described in Chapter Four, 45 percent of the farmers had passed GCE O/L and to develop the value chain it is easy to train nearly half of the sample population as around 40 percent of the sample have received secondary education. Further, more than 62 percent of the farmers had over 10 years' experience in the industry. Therefore, according to Porter's Value Chain Concept, it is easy to develop the human resources in the sector. In addition, to enhance the support services of the dairy sector, land availability is also a crucial factor. Since the study found that majority of the farmers (55%) owned less than half an acre, maintaining grasslands is difficult and land has become a limiting factor. Therefore, introducing common grassland under dairy societies will be beneficial for value chain development.

## CHAPTER FIVE

### Characteristics of Dairy Farming

#### 5.1 Dairy Management Systems

Table 5.1 illustrates the dairy managements systems followed by the farmers in the study area. In Nuwara-Eliya district majority of the farmers practice intensive and semi intensive management systems. Therefore, in the Nuwara- Eliya district 43 percent (13) of the sample population represent the intensive management practices whereas semi intensive management system is practiced by 57 percent of sample farmers. In the Kandy district, farmers were more likely to manage their herds using intensive and semi intensive methods. In the Gampaha district, 33 percent farmers practiced intensive method, 36 percent semi intensive method and 30 percent farmer's extensive method. It was evident that in the district three management practices are in use on similar scale. The main reason for the Gampaha district to have the extensive system is farmers practising buffaloes farming in extensively. Anuradhapura district shows a different pattern of cattle management. The study indicates that semi intensive method is more popular (73%) among the farmers. However, intensive and extensive methods of rearing are minimum in the sample population. This indicates that even in the dry zone dairy farming methods are changing dramatically due to various concerns such as rearing improved breeds in a herd needing improved facilities. Furthermore, in the Kurunagala district, farmers mostly manage the herds with semi intensive and extensive methods. Semi intensive farming system is practiced by 41.6 percent of the farmers and 39 percent are engaged in extensive farming. However, one fifth of the sample is engage in intensive method of management. Most of the dairy farmers in the Kurunagala district operate their farms in coconut estates, which helps cattle to graze in the coconut lands. In the Jaffna Peninsula 96 percent of the farmers practice semi intensive management whereas the rest manage animals extensively.

As described in the Porter's Value Chain, under the primary activities the management systems are important, the research reveals that majority of the farmers in all six agro climatic zones tend to practice intensive and semi intensive systems. This indicates that efficiency of the management of herds are improving specially with the improved breeds.

According to guidelines from the DAPH, in the Nuwara Eliya district, dairy farmers are advised to manage their animals under the intensive and semi intensive methods. Research reveals that most of the farmers practiced the same methods. However, the conditions within the intensive systems and semi intensive systems need to be developed for value chain enhancement. According to the study, intensive rearing is referred to as animals are fed within the cattle shed and provided all inputs to the shed.

In the Kurunagala district, to utilize the grass grown under the coconut plantations farmers prefer to manage the animals extensively. To improve the efficiency of the

value chain, adopting the systematic management approach (which ensures the inputs such as adequate feed, water and other inputs) is vital in respect of all three management systems.

**Table 5.1: Sample Population According to Method of Rearing**

District	Method of Rearing (Number of Farmers)			Total
	Intensive	Semi Intensive	Extensive	
Nuwara-Eliya	13	17	0	30
Kandy	13	15	2	30
Gampaha	12	13	11	36
Anuradhapura	5	22	3	30
Kurunegala	7	15	14	36
Jaffna	0	29	1	30
<b>Total</b>	<b>50 (26.04%)</b>	<b>111 (57.81%)</b>	<b>31 (16.1%)</b>	<b>192</b>

Source: Survey Data, 2019

Figure 5.1 illustrates the dairy management systems in the study area and it is clear that majority of the farms practice the semi intensive system in all selected districts. In Jaffna and NuwaraEliya majority of the farmers follow semi intensive method. This study clearly shows that the extensive management system is diminishing even in the dry zone areas.

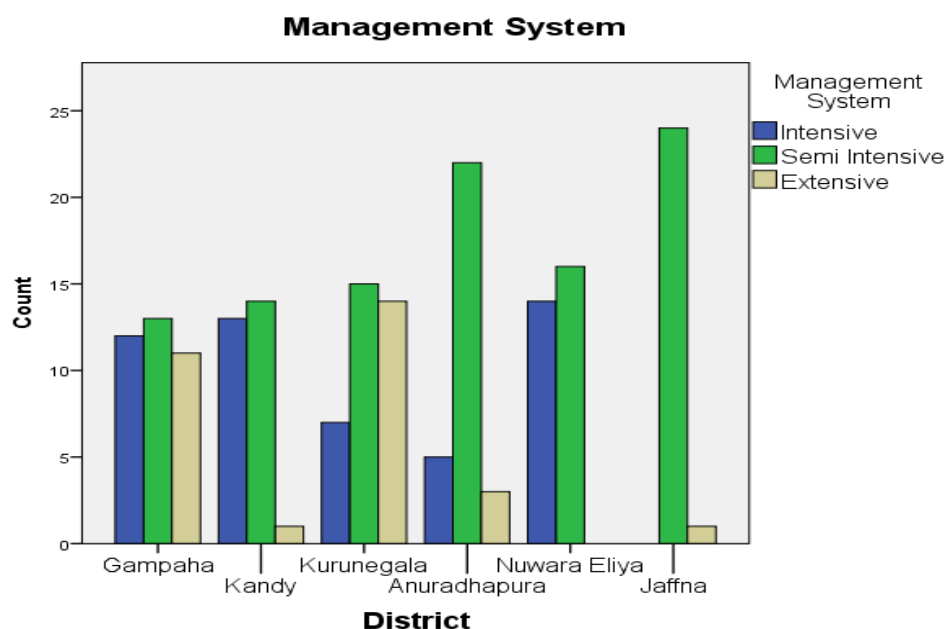

Source: Survey Data, 2019

**Figure 5.1: Dairy Management Systems**

## 5.2 Cattle Population According to Breed Type

Figure 5.2 illustrates the breed distribution of the study area. Accordingly, the Jersey breed represents over half of (53%) the total sample animals whereas Friesian represents 17 percent. Sahiwal also constitutes 12 percent of the breeds. In addition, Jersey Friesian crosses (8%), Sahiwal Jersey crosses (5%), and AFS breeds are also available in the study area.

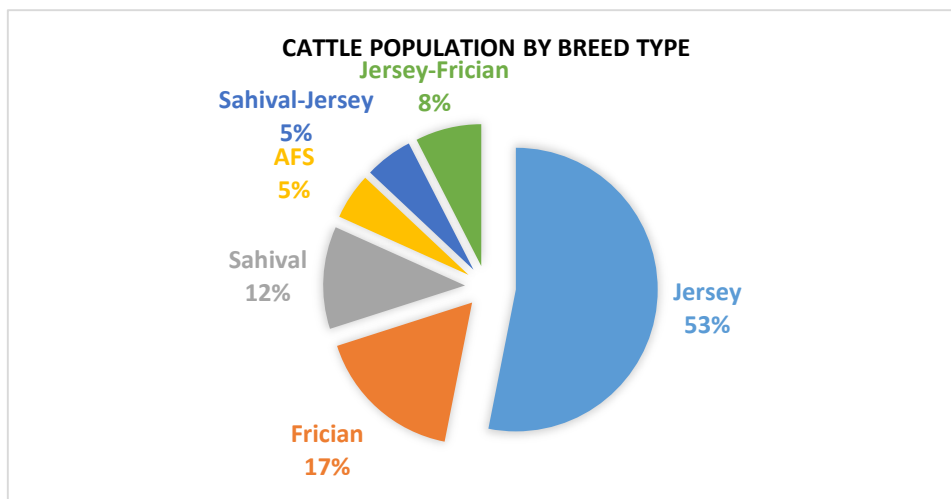

Source: Survey Data, 2019

**Figure 5.2: Distribution of Breeds in The Study Area**

Figure 5.3 presents the cattle breed distribution in different districts. Accordingly, jersey breed is dominant in the districts of Gampaha, Kandy and Anuradhapura for its heat resistant quality and their potential to produce a higher yield even in warm environmental conditions. The Kurunagala district represents the Coconut Triangle farming system and consists of other breeds such as jersey Friesian crosses, jersey Sahiwal crosses that outnumber the pure jersey and Friesian breeds. However, in the Nuwara-Eliya district, representing up country farming system has more Friesian that suits the cool climatic condition while showing higher production performance. Jersey breed represents around 45 percent of the total cattle population of the sample. In Jaffna, jersey breed represents 35 percent while Friesian are at minimum level. However, the other breeds, especially the number of crossbred are much higher than the pure improved breeds in the district.

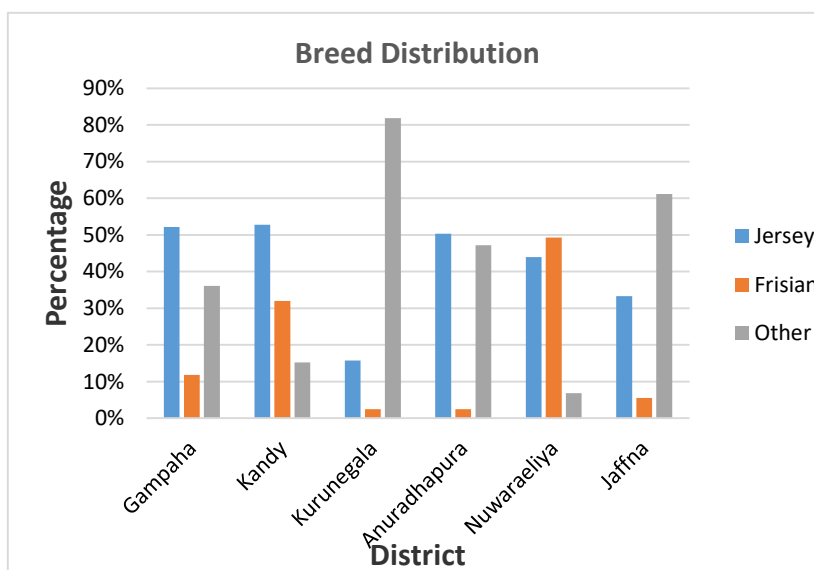

Source: Survey Data, 2019

**Figure 5.3: District wise Distribution of Breeds in Different Farming Systems**

### 5.3 Milk Yield by Breed Type

Table 5.2 explains the average milk yield of the different breeds and minimum and maximum production potentials of these animals. Accordingly, Australian Friesian Sahiwal (AFS) produces the highest average production of 9.94 litres per day and this breed recorded the highest potential yield per day, which is 14 litres. The average production of Friesian was reported as 9.76 litres per day and Jersey produces maximum of 13 litres per day in the study area. Furthermore, Jersey produces an average of 8.35 litres of milk per day and the maximum milk production potential is 14 litres per day.

**Table 5.2: Average, Minimum and Maximum Milk Yield by Breed Type**

Breed Type	Minimum litres/day	Maximum litres /day	Average litres/ day
Sahiwal	1	12	6.93
AFS	4	14	9.94
Jersey	2	14	8.35
Frisian	2	13	9.76
Sahiwal-Jersey	3	15	8.25
Jersey-Frisian	2	13	9.5

Source: Survey Data, 2019

As shown in Table 5.3, Frisian animals contribute the highest milk yield per day (13.6 litres/day) in Nuawara Eliya District. It is imperative to note that some of the areas such as Anuradhapura, Jaffna and Kurunegala Jersey Frisian cross breeds produce more than 10 litters per day. This indicates that, with intensive and semi intensive farming, farmers can obtain a better yield. This situation is prevalent in the Jaffna

district, for instance majority of the farmers practice semi intensive farming and due to the Hindu cultural influence farmers treat these animals with better care. Most of the farmers provide food which are consumed by humans. Therefore, the amount of readily available Carbohydrate that required producing milk is higher in those animals and leads to increase the average milk production per cow.

**Table 5.3: Average Milk Yield per Day per Cow by District**

Breed Type	District					
	Gampaha	Kandy	Kurunegala	Anuradhapura	Nuwara Eliya	Jaffna
Sahiwal	7.2		8.3	6.4		
Jersy	8.1	9.4	9.3	8.3	11.2	9.9
Frisian	8.4	9.5	6.3	4.2	13.6	10.3
Shahival x Jersy	6.3		6.7			
AFS	8.4	7.7	12	7.9	9.5	
Jersy-Frisian	5	6.3	10	11.8		10.1

Source: Survey Data, 2019

As shown in Table 5.4, potential lactation of different breeds differ according to the agro climatic zones. Table 5.3 explains the milk yield per animal in different districts. Accordingly, for the Gampaha district, Frisian, Jersey and Ayrshire animals were recommended by DAPH as the district comes under the agro climatic zone of low country wet zone. However, the study found that Frisian and Jersey breeds produced 8.4 litres and 8.1 litres of milk per day respectively. Per lactation average production of these two breeds were 2352 litres and 2268 litres. According to the DAPH recommendation, in intensive farming system these breeds have to produce 3000 litres and 2500 litres. However, in the study it is noted that the average production was higher than that of the recommended yield for the semi intensive system. Therefore, for the Gampaha district, Frisian, Jersey, AFS, Sahaiwal and crossbreeds are best-fitted animals to improve the milk production. Kandy and Nuwara-Eliya districts were coming under the Mid-country wet zone and mid country intermediate zone. For both zones, DAPH recommended Jersey, Frisian and Ayrshire. As the study reveals Frisian and Jersey produce the highest amount of average milk per day and per lactation while Frisian breed produces 2660 litres. This indicates that for Kandy and Nuwara Eliya districts breeds such as Frisian and Jersey are the most appropriate in terms of the yield. In addition, AFS is also a good breed for the Kandy district and they produce 2156 litres per lactation. Jersey Frisian crosses and Jersey are the best breeds for the Anuradhapura district because as recommended by the DAPH, Jersey Frisian crosses produce 3300 litters per lactation whereas Jersey produces 2324 litres per lactation. For the Low country, intermediate zone (Kurunegala District) Jersey, Sahiwal, AFS and Jersey Frisian crosses are the highest producers, which produce more than 1500 litres in semi intensive management. For the Jaffna district, Frisian, Sahiwal and Jersey Frisian crosses are the best producers.

**Table 5.4: Recommended Breeds for Different Agro Climatic Zones**

Agro Climatic Zones	Breeds	Target Lactations (Litres)	
Mid Country Wet	Frisian	> 3500	
	Ayrshire	> 3250	
	Jersey	> 3000	
Mid Country Intermediate	Frisian	> 3500	
	Ayrshire	> 3000	
	Jersey	> 3000	
	AFS	> 2000	
Low Country Wet	Frisian Ayrshire Jersey	Intensive	Semi Intensive
		> 3000	} 1500
		> 2750	
		> 2500	
Low Country Intermediate	Frisian Ayrshire Jersey AFS	Intensive	Semi Intensive
		> 300	} 1500
		> 2750	
		> 2500	
		> 2500	
Low Country Dry	Ayrshire	> 1750	
	Frisian	> 1500	
	Sahiwal	> 1250	

Source: Cattle Breeding Policy, Department of Animal Production and Health (2010)

#### 5.4 Herd Size

As illustrated in Table 5.5, the number of neat cattle in the herds of different districts were identified. Accordingly, 44 percent of the sample population represent the herds comprising less than five animals. A herd of 5-10 animals represents 28 percent of the sample population. Twenty-six percent of the farmers in the sample owned 10 to 50 animals and only two percent of the farmers possess more than 50 animals per herd. It is observed that herds comprising more than 50 animals usually can be found in the districts such as Kurunegala and Anuradhapura where a higher number of animals are managed extensively. According to the DAPH classifications, dairy farmers are categorised in terms of the number of animals they rear: small scale less than 10 per herd; medium scale 10-50 animals and large-scale more than 50 animals per herd. Therefore, it can be concluded that majority of the dairy farms operate at small scale.

**Table 5.5: Herd Size of the Study Area**

No. of Neat Cattle	District (Number of Farmers)							Percentage
	Gampaha	Kandy	Kurunegala	A'pura	Nuwara Eliya	Jaffna	Total	
5>	1	23	9	2	22	27	84	44
5-10	18	6	12	9	5	3	53	28
10-15	8	0	5	11	3	0	27	14
15-50	9	1	7	7	0	0	24	12
50 <	0	0	3	1	0	0	4	2

Source: Survey Data, 2019

#### 5.4.1 Herd Composition

According to Table 5.6, a herd comprises of milking cows, male calves, female calves, Heifers and dry cows. Milking cows represent 39 percent of the total herd. However, according to the national dairy herd composition, milking cows represent 29 percent of the total herd. The study reveals that having more milking cows in a herd is indicative of proper management of the herd. As indicated in the Census and Statistics Agriculture Data (2019), both male and female calves represent 24 percent of the national herd. According to the study, 20 percent female calves and 18 percent of male calves represent a herd. In Nuwara-Eliya and Jaffna districts, the milking cow percentage is much higher than the national average as well as the study average. In the Nuwara-Eliya district, the milking cows denote 58 percent whereas in Jaffna it is 73 percent. This indicates that dairy farming practices of Jaffna and Nuwara Eliya districts are on a much higher scale when compared with other districts considering the number of milking cows in a herd as it enhances the milk production of the farm.

**Table 5.6: Average Herd Composition of the Study Area**

Type	District (Percentage)						Total Percentage
	Nuwara Eliya	Kandy	Gampaha	Anuradhapura	Kurunegala	Jaffna	
Milking Cows	58	34	37	31	36	73	39
Male Calves	10	33	14	15	16	-	16
Dry Cow	6	6	10	18	13	5	11
Heifer	9	9	16	20	12	2	14
Female Calves	17	18	23	15	23	20	20

Source: Survey Data, 2019



## 5.5 Cattle Shed Availability

Cattle shed or providing appropriate housing is significant in dairy farming. An efficient management of herd in cattle shed will provide facilities to provide required space, convenient feeding and drinking environment, proper sanitation and higher potentials in clean milk production. Depending on the type of management, dairy farmers maintain cattle sheds in the study area. Accordingly, 83 percent of the farmers maintain cattle sheds in their farms. It is clearly indicated that, farmer who practice intensive (26%) and semi intensive (57%) farming have cattle sheds. Other farmers who practice the extensive method of rearing do not have cattle sheds.

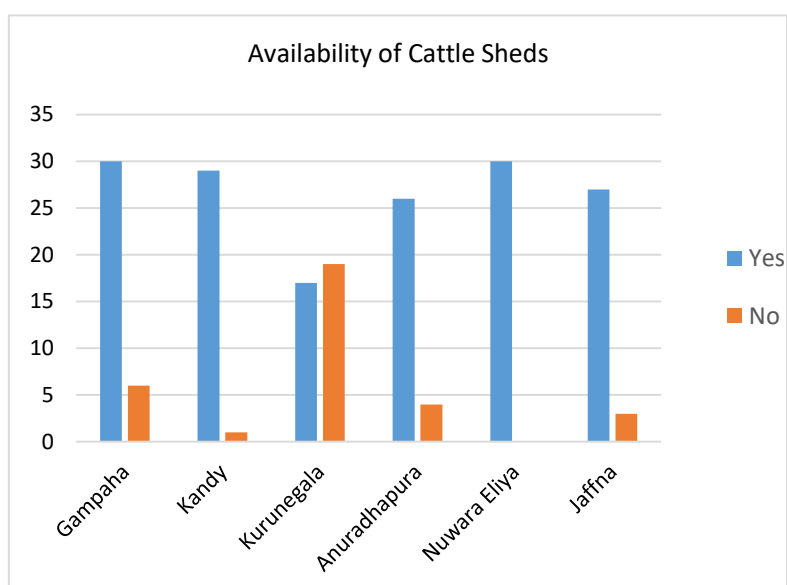

Source: Survey Data, 2019

**Figure 5.4: Availability of Cattle Sheds in the Study Area (%)**

Figure 5.4 illustrates the cattle shed availability of different farming systems in the study area. Accordingly, in the Nuwara- Eliya district all the interviewed dairy farms had cattle sheds. In the districts such as Kandy, Anuradhapura, Gampaha and Jaffna, fewer farmers do not have cattle sheds. However, in the Kurunegala district half of the farmers do not have cattle shed facilities because some farmers manage herds extensively in coconut estates. In general, In the Nuwara Eliya district farmers maintained small scale dairy units with limited land.

## 5.6 Cattle Insurance

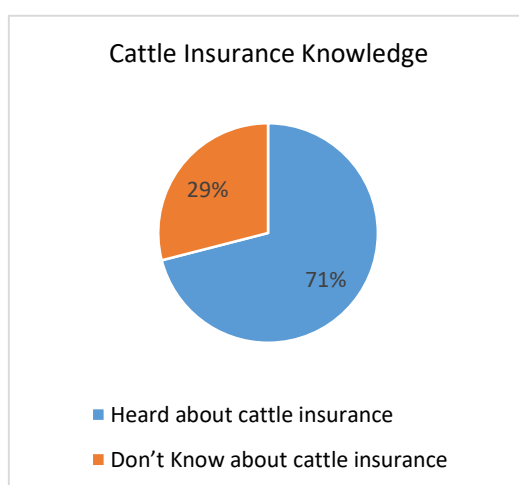

Source - Survey Data 2019

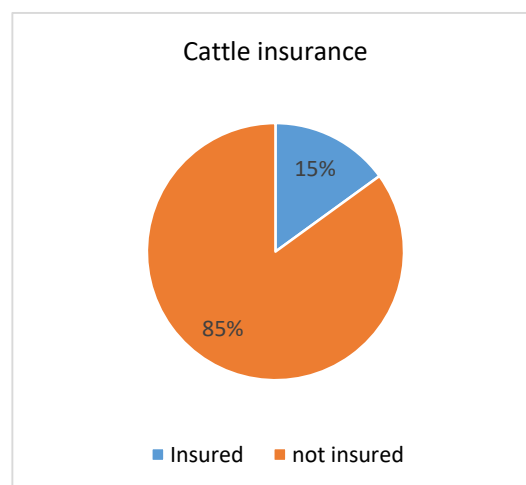

Source - Survey Data 2019

**Figure 5.5: Knowledge of Cattle insurance    Figure 5.6: Insured Animals**

Figures 5.5 and 5.6 illustrate the cattle insurance knowledge and percentage of insured animals in the study area. The study found that 71 percent of the farmers were aware of the cattle insurance schemes while 29 percent were not. However, the farmers admitted that cattle insurance is important. According to the study, 85 percent of the farmers did not insure their animals. However, 15 percent of the farmers have insured one or two milking animals in their herds. In addition, farmers who received animals from government projects had also insured them. Further, none of the sample farmers had not included any recently imported animals and incidence of death. However, death of milking animals can have a serious impact on the milk yield and the economy of the farmers. Therefore, the insurance programmes should be modified and easily accessible for any dairy farmer and it is also important in value chain development. Even in the Porter's Value Chain Concept, continuous supply of input is essential for the chain development.

## 5.7 Record Keeping

Record keeping is an essential element in successful dairy management. Farmers usually rely on their memory when making decisions. The study reveals that in the study area only nine percent of the farmers maintain records on their dairy farming activities. However, 91 percent of the farmers do not maintain records on their dairy herds. In a dairy farm, different types of dairy records can be maintained. The common records maintained are the milk yield records maintained at collecting centres.



## CHAPTER SIX

### Value Chain Actors

#### 6.1 Input Supply

The input supply of dairy industry consists of several categories such as feed, medicine, vitamin, mineral, water, breeding material, services such as veterinary service, extension, and processing herd facilities.

#### 6.2 Feed Supply

Feed, which is one of the most important aspects of input supply, are two types: mainly forage supply and concentrate feed supply. Forage supply in Sri Lanka consists of dry forage like hay and silage. Fresh forage is supplied through cut and feed or allow animal to graze. In Sri Lanka, most of the farmers depend on natural grasslands. However, fewer farmers maintain their own grasslands.

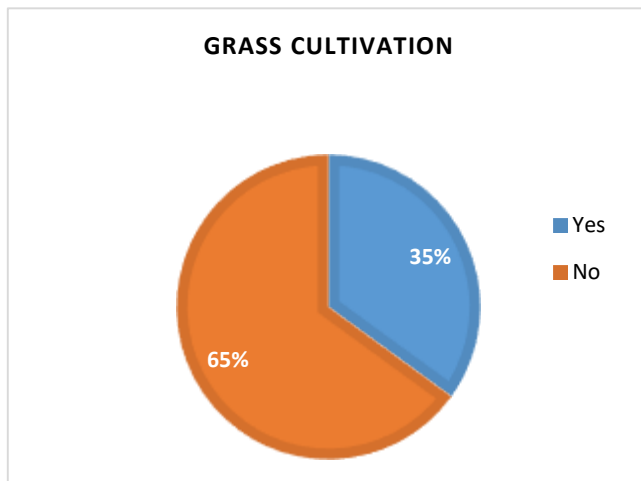

Source: Survey Data, 2019

**Figure 6.1: Grass Cultivation by Farmers**

As shown in Figure 6.1, 35 percent of the farmers expressed that they grow grasses in their dairy farms and 65 percent of the farmers stated that no grasslands are maintained and they rely on the roadside grass and natural grasslands.

### 6.2.1 Size of Grasslands

**Table 6.1: Size of Grasslands and Distribution**

Grass Land (perch)	Number of Farmers	Percentage
20>	16	24
20-40	19	28
40-60	2	3
60<	30	45

Source: Survey Data, 2019

Even though 35 percent of farmers are engaged in grassland maintaining, the area they maintain is not sufficient. More than 60 perches were cultivated by 45 percent of the grass-growing farmers in the sample. Further 24 percent of the farmers own less than 20 perches of lands. It is evident that 55 percent of the grass-cultivating farmers maintain less than 60 perches of land area and most of the small scale farmers do not own the required land resource to maintain the grasslands as per the feed requirement of the herd.

Figure 6.2 illustrates the type of grass varieties mostly grown by farmers and more than 90 percent of the farmers grow Co-3 in their farmland.

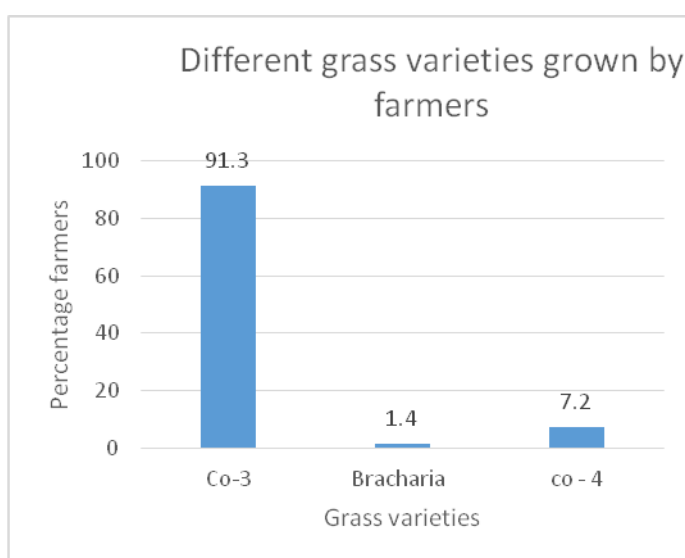

Source: Survey Data, 2019

**Figure 6.2: Different Grass Varieties Grown by Farmers**

The research also reveals that two farmers who operate large-scale dairy farming maintain the grasslands of an extent of around four acres and have cultivated the improved grass types such as Co-3 and CO-4. These farmers prepared hay within their farms to feed the animals during the dry season of the year. However, silage-making farmers were not identified among the sample. Furthermore, 20 percent of the sample farmers maintained more than one acre of grassland in the study area. It

is also noted that the improved grass variety of CO- 4 is becoming popular among the dairy farmers in Sri Lanka. The Indian Council of Agriculture Research (2012) describes that CO-4 matures before CO – 3 and scientific management and leaf width and size of the plant was also better than that of CO-3. Further, it is more succulent, palatable and liked by cattle. Feeding one bundle (15kg) of CO-4 would increase the yield by 200 ml per cow. With these improvements farmers tend to grow CO-4 in place of Co-3.

### **6.2.2 Concentrate Feed Supply**

Concentrates are low-fiber, high-energy feeds and rich in protein. Most often, the use of concentrate feeds raises the energy level of the ration of dairy cattle and compensates for any other deficiencies that remain beyond those provided by the forage portion of the ration. Concentrate feed consists of energy, protein, fiber, micro-minerals, macro-minerals and vitamins. Most of the farmers believe that to obtain a higher milk yield providing concentrate feeds is vital. Study shows that 95 percent of the dairy farmers provide concentrate feeds to the milking animals in their herds. The farmers who do not provide concentrate feed practice dairy farming using extensive methods and some of them stated they do not have financial stability to provide concentrate feeds to the milking animals of the herds.

There are several concentrate feed types available in the input markets of the study area. Prima feed is the most famous among the dairy farmers. Ceylon Grain Elevators produce and distribute the Prima cattle feed. In addition to processed concentrate feed, poonac, rice brand, dhal husk, omi are other types of concentrate feeds in the study area. Generally, a kilogram of Prima feed costs above Rs. 60 whereas poonac and dhal husk costs Rs. 55/= and Rs. 40/= per kg. respectively. Rice polish and rice bran also shows high demand at present in the dairy input market and the price of rice polish varies from Rs. 25/= to Rs. 30/= per kg. When focusing on the amount of concentrate feed and the average milk yield of the animals in the study area it was observed that farmers who provide less than 0.5 kg of concentrate feed obtain an average milk yield of 2.91 litres per day without considering the breed differences. The farmers who supply 0.5 kg - 1kg commercial feed yields 2-4 litres of milk and by providing more than 2kg of concentrate feed a yield of around seven litres of milk per day can be obtained. However, these production capabilities are most likely to depend on the breed type and the management practices of the farm.

It was noted that most of the dairy farmers rely on commercial concentrate feeds available at the market to increase the milk production. However, it is important to encourage dairy farmers to produce dairy feeds such as hay and silage using the grasses that are freely available during the rainy seasons. Hence, assistance of extension service and the institutional support is essential to introduce these methods. The farmers complained that finding quality concentrate feed and other essential inputs are difficult and traders sell those inputs without maintaining a fixed market price. Therefore, establishing regional level input supply centers will provide the easy access and affordability of the concentrate feed at a low cost. Furthermore, strengthening provision of feed supplements made using local ingredients is also

important and research and development should be directed to expand the concentrate feed supply sector.

### 6.3 Water Supply

Water supply also plays a significant role in improvement of dairy production. Water is essential for maintaining body fluids and proper bodily balance; digesting, absorbing, and metabolizing nutrients; removing waste material and excess heat from the body; providing a fluid environment for the fetus; and transporting nutrients to and from body tissues. Dairy cattle get the water they need by drinking and consuming feed that contains water, as well as from metabolic water produced by the oxidation of organic nutrients. Water loss from the body occurs via urine, feces, and milk; through sweating; and by evaporation from body surfaces and the respiratory tract (Michael and Dan, 2007). The amount of water lost from a cow's body depends on the animal's level of activity, air temperature, humidity, respiratory rate, water intake, feed consumption, milk production and other factors. According to the literature, cows need 60 to 120 liters of water depending on the body weight, climatic condition and the physiological status of the animal (Michael and Dan, 2007). Drinking water covers 80- 90% of the dairy water requirement and the rest is taken in as feed. Free access to water is very important in dairy production improvements.

As described by Figure 6.3 there are three main water sources identified in the study area. Majority (52%) of the dairy farmers in the sample rely on well water. Pipe borne water was utilized by 25.5 percent of the sample whereas river or lake water is used by 23 percent of the dairy farms in the sample. The farmers who practice extensive farming are more likely to use well water and river or lake borne water. Dairy farms managed under the intensive system mostly utilized the pipe borne water.

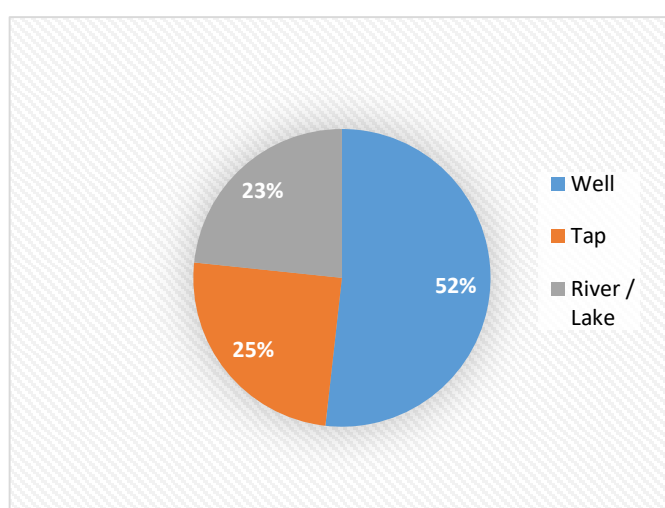

Source: Survey data, 2019

**Figure 6.3: Available Water Sources in The Study Area**

#### **6.4 Labour Supply**

Most of the small-scale dairy farmers utilize family labour for their dairy farms. Full time dairy farmers who engage dairy farming as their main employment spend whole day for dairy farm management activities. As the study indicated, an average small-scale farm of 6 animals in a herd has to spend 7 hours per day for the dairy management activities. Farmers complain that new generation wouldn't like to initiate or engage in dairy farming as it is not socially much recognized and also since providing quality feed and other input management of the dairy farming is challenging.

#### **6.5 Veterinary Services**

Veterinary services are mainly supplied by the regional Veterinary Surgeons' (VS) offices under the Department of Animal Production and Health. The study reveals that all of the dairy farmers obtain veterinary services from the VS office for disease control. However, fewer farmers explained that they also receive information through other experienced farmers and even from the internet.

The study reveals that in the study area the common diseases among dairy animal are bloating, tick fever, mastitis, foot and mouth disease, and complications in delivering calves. The farmers explained that Veterinary Surgeons visited the farms and provide the medicine on these occasions.

#### **6.6 Animal Breeding**

Milk producers can increase productivity and returns from dairying through selective breeding and control of reproduction. Reproductive efficiency (e.g., calving intervals, conception rates) can be improved by using genotypes that are suitable to the production environment, and appropriate husbandry practices. Reproductive performance of dairy animals is determined by the factors such as the environment, animal nutrition, producers' socio-economic conditions, dairy animals' adaptability and genetic characteristics, and type of production system (intensive or extensive) (Chandrasiri, 2002). Even though the small-scale dairy producers lack scientific knowledge of genetic background of the animals, they have higher practical knowledge on breeds and their management.

In the sample survey dairy farmers practiced both natural breeding and artificial insemination in their herds to obtain new animals to the herd. This study reveals that 95 percent of the farmers opted for artificial insemination as a breeding method and five percent of the farmers practice natural breeding by borrowing a high quality bull from other farms or commercial farms in the respective area.



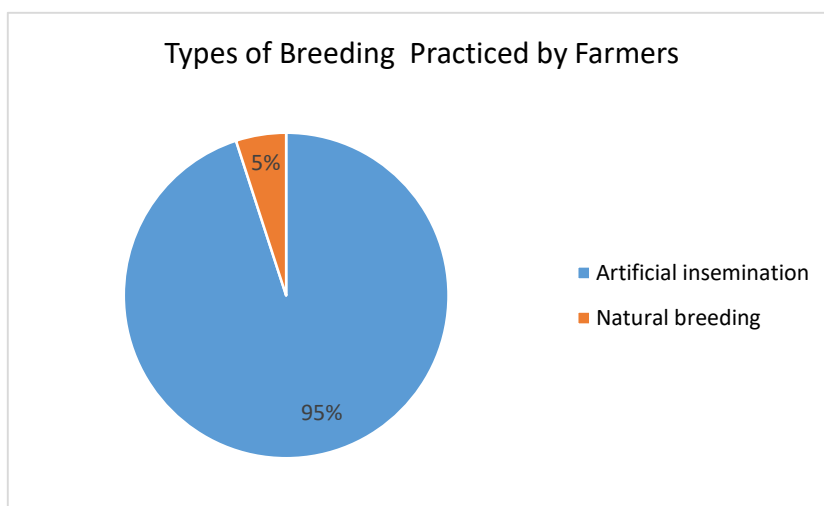

Source: Survey Data, 2019

**Figure 6.4: Breeding Types Practiced in Herds**

The study also explained that 74 percent of the sample farmers obtained advice from the Livestock Development officers whereas 26 percent of the farmers received advice from the Veterinary Surgeons. As the study illustrates, 90 percent of the farmers are capable of obtaining the AI service from the officials. However, 10 percent of the farmers stated that they were unable to obtain the AI service at the required time. In addition, the importance of having a mobile veterinary service unit in the dairy dominant areas of the country was also stressed. Most of the farmers and officers focus on the importance of 24-hour service and holiday service to the required dairy farmers, to enhance the turnover of the dairy industry in the country.

As illustrated in Figure 6.5, 60 percent of the farmers explained that, the service of Livestock Development Instructors (LDI) are satisfactory. Most of the LDIs try to reach within the expected time for an artificial Insemination. In addition, according to their time availability they provide other required extension services to the farmers. Thirty percent of the sample responded that the service of those officers are highly satisfactory. However, around 10 percent believed that the expected service was not delivered from the vet office. Fewer farmers also explained that they have to pay an increased sum on medicine, and other treatments when animals become ill and noted the importance of subsidizing those activities.

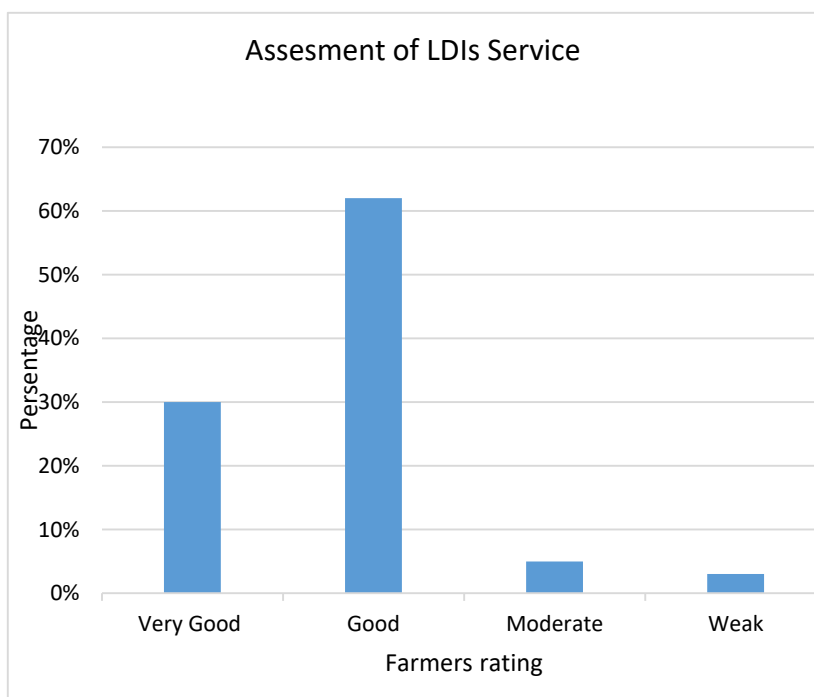

Source: Survey Data, 2019

**Figure 6.5: Farmers' Assessment of Service of LDI**

### 6.7 Medicine

In dairy farming medicine also plays a crucial role. The farmers explained that worm and tick treatments are very expensive, and there is no controlled price for these medicines. Therefore, the farmers stressed the importance of price control mechanisms for medicines such as worm and tick treatment medicines.

### 6.8 Other Inputs

In dairy farming except feed, water, labour, veterinary service, breeding, and extension services, other inputs such as ropes, buckets, milk transport cans, disinfectants and other essential inputs in milk processing is available from the local markets in the nearby cities or towns.

### 6.9 Output Market

In Sri Lanka, generally majority of the farmers sell their milk in the form of raw milk to the milk collectors in respective areas. In the sample population, 94 percent of the farmers sell their milk as raw milk to the main collectors in their area. Six percent of the sample population engage in value added production or milk processing, such as manufacturing curd, yoghurt, drinking yoghurt and ice-cream. In the Sri Lankan dairy sector, the most common value chain is milk producer (farmer) selling milk to the milk collector and the processor.

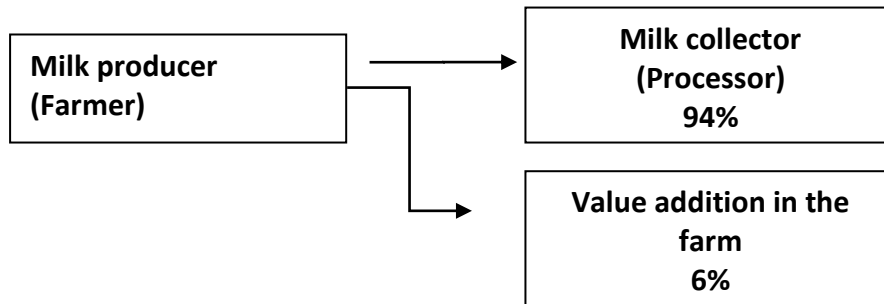

Source: Survey Data, 2019

**Figure 6.6: Simplest Value Chain**

### 6.10 Milk Collectors

Figure 6.7 illustrates the availability of milk collectors in the study area. Accordingly, 51 percent of the respondents sell their milk to Milco private limited. In the Jaffna Peninsula the dominant milk collector is YALCO and they buy most of the milk in the Jaffna district. Cargill's is also a leading milk collector in the study area and it is observed that Cargill's collects more milk in some areas. In addition, Nestle, Rich life, cooperative societies, other small-scale milk processors and collectors are also engaged in milk collection.

In the Nuwara- Eliya district, 73 percent of the farmers sell their milk to Milco and the rest of the farmers sell to Palawatta, other private collectors and hotels. In the Kandy district also Milco is the leading collector and Nestle and other private collectors also engage in milk collecting. In the Kurunegala district, Milco is the main collector and Nestle, Cargill's and other cooperative societies also collect a significant amount of milk. In the Anuradhapura district too Milco is the leading collector. However, in the Gampaha district Cargill's collect 49 percent of the sample farmers' milk. In addition, Richlife, cooperative societies and Milco also collect milk in the district. In general, Milco acts as the main collector and even in high production seasons farmers can sell their products to Milco. In certain areas in the Kurunegala district Milco collects milk in the evening as well.

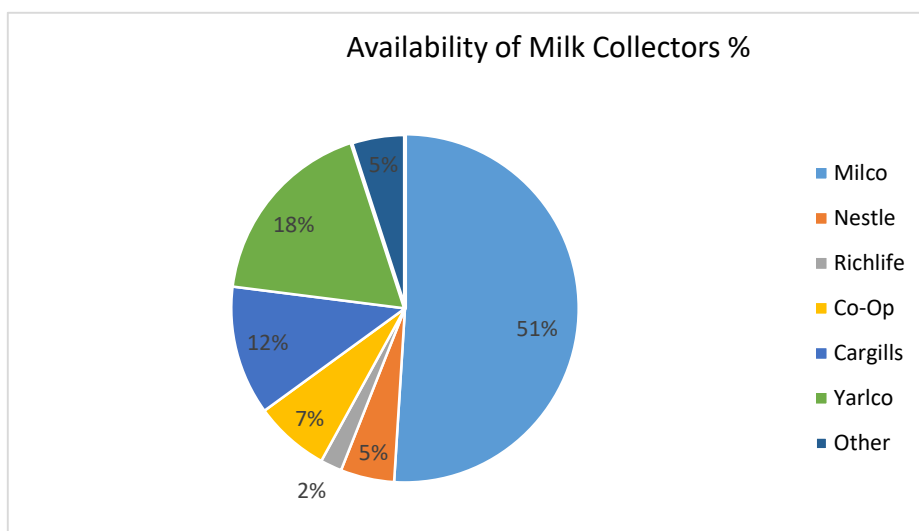

Source: Survey data, 2019

**Figure 6.7: Distribution of Milk among the Collectors in the Study Area**

**Table 6.2: Milk Collecting Centres and Places of Value Added Products**

District	Number of Milk Collecting Centers	Places of Production of Value Added Milk Products
Gampaha	144	145
Kandy	251	55
Hambanthota	65	359
Killinochchi	72	6
Kurunegala	855	148
Anuradapura	487	82
Jaffna	77	7
Matale	167	29
Nuwara Eliya	247	33

Source: Department of Animal Production and Health, 2019

As shown in Table 6.3 from 2014 to 2018 the number of milk collecting centres have increased over the years. However, the number of milk processing centres have reduced during the same period. Most of the farmers explained that the small-scale milk processing centres, especially the yoghurt production are challenged by large scale companies. In addition, due to land limitations, the number of traditional curd processing centres have also reduced, as the farmers could not find the required amount of buffalo milk for processing. Therefore, the small scale processing centres are diminishing over the years.

Tables 6.3 and 6,2 describe the number of milk collecting centres and places of value added production centres. Accordingly, Kurunegala district has the highest number of collection centres. It is mainly due to increased dairy production and the number of private collectors. In the Hambanthota district the number of milk processing

centres are the highest among the study area. This is due to the curd processing centres clustered in the district.

**Table 6.3: Number of Milk Collecting Centres in 2018**

Year	Number of Collecting Centres	Places of Production of Value Added Milk Products
2014	3,264	3,122
2015	3,430	2,341
2016	3,503	2,385
2017	3,637	2,442
2018	3,793	2,350

Source: Agriculture & Environment Statistics Division Dept. of Census & Statistics, SL.

### 6.11 Milk Collecting Agents

According to the Porter's Value Chain Concept, outbound logistics such as storage, transportation and product distribution are main responsibilities of the milk collector. These milk collectors are also engaged in primary activities such as marketing, sales and customer services.

#### Milco

Milco private limited is the biggest and the most popular state sector organization and the strongest milk-collecting network functioning all over the country. Principal activities of the company were collecting, processing, packaging, distribution and producing milk related products. Milco is the most popular milk-collecting agent in the study area. Milco has formed Dairy Farmer Managing Societies in the milk collecting centres and introduced several welfare facilities to the dairy farmers. Milco collects 170,000 litres of milk daily and in four factories they produce several value added products. According to the DAPH information, Milco daily collects around 150,000 litres of milk daily and engages in value added products under the trade name of Highland. Highland dairy products are very popular and people prefer to consume Highland products as the company is state owned and they trust that the products comply with advanced and safe hygienic conditions. Milco produces pasteurized milk, sterilized milk, yoghurt, curd, butter, ghee, processed cheese, ice cream, condensed milk and UHT milk. Milco being a state owned company continues the value addition process by protecting the consumers as well. Milco as the largest collector, it is essential to improve the outbound logistics such as storage facilities by introducing mini coolers in the dairy organization level which helps strengthen the evening milk collection and improve value chain efficiency.

#### Nestle

Nestle is a multinational company and one of the world's largest beverage companies. It is one of the largest private sector milk collectors operating all over the island. In addition, Nestle is one of the world's largest coconut milk powder exporter.

Nestle milk factory is located at Pannala. Nestle milk collectors also have formed Farmer Managing Societies and provide several welfare benefits to dairy farmers. In addition, they have introduced some important rules and regulations to maintain clean milk production and advise dairy farmers and collecting centre workers to ensure clean milk production. According to the amount of milk supplied, the farmer centric benefits also change. Farmers who supply milk continuously for two years will receive benefits for incidences like: death of a family member, death of the parents of milk farmer, educational achievements of family members, and for disable situation of a farmer and for important life events (wedding). However, if farmer does not supply milk continuously for two years their membership will be terminated. As described in the Porter's Value Chain Concept under primary activities, production of quality products and ensuring customer satisfaction is important. Therefore, as Nestle practices, to develop the dairy value chain, production of clean milk and following standard practices are important.

According to the quality of the milk, Nestle determines the price of the milk purchased. In the case of disease incidence Nestle provides free essential medicines to the farmers. In addition, Nestle provides support to build cattle sheds and for large scale dairy farmers Nestle supports with loan facilities.

In addition to Nestle and Milco, in the Jaffna district the milk collection centres such as YALCO and LIBCO play vital roles in milk collection and processing.

## **YALCO**

YALCO is the most popular milk collector in the Jaffna district. Nine hundred farmers supply milk to the YALCO collecting centre. There are 27 milk collecting centres available in the district. Usually around 6000 litres of milk are collected daily. YALCO consists of 61 employees. The Board of Directors of YALCO consists of six farmers and three officials. From the six farmers, two are young farmers who are below 35 years. Farmers are selected to the board from an election. Out of three officers, the district government agent selects two officers. The Ministry of Agriculture selects the other officer.

From the total collection, 75 percent of the milk is sold as raw milk to the identified customers. The remaining 25 percent is utilized to produce value added products such as yoghurt, ice-cream, ghee, paneer, curd, lollipop, iced milk packets and pasteurized milk. YALCO collects milk two times a day, 7 am in the morning and 2.30 pm. Milk pricing is determined by the fat and SNF content of the milk.

Table 6.4 explains the cost of production of dairy products produced by YALCO. Accordingly, one kg. of paneer costs around Rs. 500/= whereas non-fat paneer production costs Rs. 1000/kg because cream separation is a costly operation. According to YALCO representatives, paneer is a popular product in Jaffna and to produce one kg. of paneer, seven litres of milk are required. According to the cost of production, YALCO determines the selling price of the products to maintain the enterprise as profitable venture.

**Table 6.4: Cost of Production of Different Products**

Product Type	Unit	Cost of Production
Ice-cream	1 cup	20.00
Yogurt	1 cup	20.00
Milk Lolly	80ml	7.50
Curd	1 L	70.00
Milk Toffee	1 piece	6.00
Paneer (fat)	1 kg	1000.00
Paneer (nonfat)	1 kg	500.00
Pasteurized Milk	500ml	46.00
Ghee	750 ml	1025.00

Source: Survey Data, 2019

YALCO also provides animal feed to the farmers on loan basis. It includes dhal husk and mineral mixture. Gingerly poonac and coconut poonac are usually provided on request. The feed costs are deducted from the milk earning. UNDP provides Rs. 5 for every litre of milk and under this agreement the dairy farmer and farmer are automatically building a fund in the YALCO. Farmers are eligible to receive that money as a loan. Ninety percent of this money can be taken as a loan by the dairy farmers, and this loan should be repaid within a year.

#### **LIBCO (Livestock Breeders' Cooperative Society)**

LIBCO milk collecting and processing centre is situated in the Jaffna Karaveddy GS division. This milk-processing centre started after 2007. There are six branches and it is running as a milk cooperative. At present, there are 18 employees working in LIBCO and they produce curd, ghee, paneer, yoghurt, milk toffee, iced milk packets. They collect daily 400 litres of milk and sell 300 litres of milk in the form of raw milk and 100 litres of milk are used for producing value added products. Evening milk collection does not function properly due labour shortage. Limited evening milk collection decreases the efficiency of the value chain and it is important to provide mini coolers at village level or for Farmer Managing Societies. LIBCO on average pay Rs. 67/= per litre of milk and deducts one rupee as compulsory saving to the farmers and for each litre the company contributes 50 cents as compulsory saving.

Table 6.5 illustrates the cost of production and selling prices of different processed products produced by LIBCO. Production of paneer is higher during the wedding season and curd production increases during the festive season. In addition, production of iced milk packet or milk lollies is higher in the sunny period.

**Table 6.5: Cost of Production, Wholesale Price & Retail Price**

Product and unit	Cost of Production (Rs.)		Wholesale Price (Rs.)	Retail Price(Rs.)
		Label Cost		
<b>Curd</b>		4.00		
150 ml	20/=	(Printing)		30/=
250ml	30/=	6.90		40/=
500ml	56/=	14		70/=
1 l	100/=			130/=
<b>Yoghurt</b>	11/=	Printing Label 4.13/=	20/=	25/=
<b>Paneer</b>	850/= Per kg		950 Kg	1200/= Per Kg
<b>Ghee</b>				
1 bottle	700/=		900/=	1000/=
¼ bottle	175/=		225/=	250/=
½ bottle	350/=		450/=	500/=
<b>Milk Toffee</b> (1 Piece)	3.50/=		5/=	4/=
<b>Milk Lolly</b> (1 Packet)	6.50/=		8/=	10/=
<b>Non Fat Paneer</b> (1 Kg)	570/=		750/=	850/=

Source: LIBCO Data, 2019

### CIC Dairies

CIC Dairies milk factory is situated at Dambulla and there are 550 farmers registered under CIC Dairies. There are six main routes that CIC collects milk from:

- Route number 01- Matale- Nalanda Road
- Route number 2 – Colombo- Malsiripura Road
- Route number 3- Galewela- Kalawewa Road (Namal Uyana)
- Route number 4- Pollonnaruwa road up to Habarana
- Route number 5 – Kakirawa Road
- Route number 6 – Bakamuna Road Dambulla

When there is surplus milk during the September to December period, CIC Diaries collect 4500 litres of milk per day. However, during the lean period (January to April) they collect only 2900 – 3500 litres of milk. According to the quality of milk CIC pays Rs. 63 to Rs.67 per litre. While transporting the raw milk, the company maintains the quality of the milk by conducting an alcoholic test, when there is a problem. The CIC officials informed that the company maintains the milk quality by conducting frequent checking. If the milk quality is inferior, the company rejects the milk and provides a detailed report stating the reasons for rejection.



## **Benefits Given to The Farmers by the CIC Dairies**

1. Provide financial benefits on special occasions of the dairy farmer's family
2. Provide dairy inputs at a subsidized rate. Medicines are provided and CIC deducts the cost from the milk income.
3. Provide a welfare facility by adding Rs.0.20 cents to every litre of milk.
4. CIC provide training facilities to the farmers who joined newly on milking, feeding of animals, preparation of silage, prevention of diseases etc.
5. CIC is jointly working with NADAP and provide facilities to the regional milk collecting centres to upgrade the quality of milk.

## **Palwatta Dairies**

Palwatta Dairy Industries Ltd, is a leading manufacturer of the locally produced dairy products. According to 2017 statistics, they support 25,000 to 30,000 farm families. Palwatta collects 150,000-200,000 litres of milk per day. They produce butter, yoghurt, ice cream, liquid and powdered milk, flavored milk, ghee etc. Depending on the fat and solid non-fat content the price of the milk is determined at the collection centres. They also have formed Famer Managing Societies at the milk collection centres. Animal feed is also supplied on loan basis at the milk collection centres and the loan is deducted from the milk earnings. This situation indicates that the company has formed an efficient milk collection network and other than Milco, Palawatta produces powdered milk.

## **Cargills Dairies**

Kothmale brand is one of the leading brands in the dairy production sector and which is managed under Cargills Dairies. It was established in 1967 at Bogahawatta, Pathyana, Upper Kothmale. The mission of the Cargills Dairies is to become the most trusted dairy brand in Sri Lanka and their mission is to become the largest contributor to the national dairy industry. At present, Cargills collects 170,000 litres of milk daily. Cargills Dairies also maintain Famer Managing Societies at the collection centres and have introduced welfare measures to the dairy farmers. The farmers are entitled to benefits after continuously supplying milk for six months and registered with the Cargills by completing documentation process. Farmers receive benefits for educational achievements of the family members, in the event of death or permanent disability.

## **Rich-life Dairies**

Rich-life Dairies Ltd. member of Renuka Shaw Wallace PLC, is a premier private sector milk collector, food, and beverage company in Sri Lanka. They also maintain Famer Managing Societies in the milk collecting centres. Depending on the quality of the fresh milk, Richlife fixes the pricing mechanism of the milk. The primary focus of Richlife is to strengthen the milk collection network throughout the country and extend support to the rural dairy farmers to uplift their economy.

As revealed by the study, Milco is the leading collector and distributor all over the country. In addition, Nestle, Richlife, Palawatta, Cargills are the top collectors, processors and distributors. Further, some private collectors also collect milk and are engaged in the milk processing industry. The well-established state and private dairy companies create a competitive milk collecting network and depending on the fat and solid non-fat content the milk pricing is determined by the company. LIBCO and YALCO are the milk collectors that operate in the Jaffna district. All the private companies and other private collectors complain that there is no sufficient and stable milk production around the year and they are also engaged in enhancing the quality and the quantity of milk and dairy farmers' wellbeing.



## CHAPTER SEVEN

### Dairy Development and Policy Issues

#### 7.1 Introduction

Prior to open economic policies introduced for milk in 1970s the imported quantity of milk was low and there were no reported adverse effects on the dairy industry of Sri Lanka. However, with the liberal economic policies the pattern has changed over time and milk powder importation has increased rapidly and trading of milk powder became a high profitable venture because the global prices of milk and milk products being relatively low due to highly subsidized systems of developed countries which encouraged dairy product exports (FAO). Majority of the Sri Lankans preferred to consume imported powdered milk. In 2018, Sri Lanka spent Rs.58 billion to import milk and milk products, it shares 60 percent of the total milk, and milk based requirement of the country.

#### 7.2 Institutional Support for Dairy Development

The Department of Animal Production and Health (DAPH) is the main state organization responsible for providing technical leadership to the dairy sector and its stakeholders. The DAPH presently operates five (05) divisions such as Animal Health, Animal Breeding, Veterinary Research, Human Resource Development, Livestock Planning and Economics. The Department is also responsible for livestock extension services.

As shown in Table 7.1, there are 327 veterinary offices functioning in nine provinces and administrated by the Provincial DAPH. In each Veterinary Surgeon's Office, a Veterinary Surgeon, Livestock Officers and Livestock Development Instructors provide services to enhance the livestock development of the country. However, according to the discussions held with relevant officers and dairy farmers, the staff is not sufficient to provide required services to meet the production targets. In addition, establishment of production target extension units at regional level is also essential. The provincial DAPH centres are responsible for the implementation of livestock development activities in the respective areas.

**Table 7.1: Veterinary Service Centres in Sri Lanka**

Province	Veterinary Surgeon's Office
Central	45
Eastern	45
North Central	31
North West	38
Northern	34
Sabaragamuwa	28
Southern	42
Uva	32
Western	32
<b>Total</b>	<b>327</b>

Source: Department of Animal Production and Health, 2018

Other than the DAPH, institutes such as the National Livestock Development Board (NLDB) are committed to uplift the livestock and dairy industry in Sri Lanka by providing quality breeding material, livestock and agricultural products incorporating new technology and innovations for making the country self-sufficient in livestock and dairy products. In addition, NLDB facilitates in enhancing grass cultivation in the Coconut Triangle and popularizing the fresh milk consumption among the nation by establishing sales outlets at farm Level Island wide.

The main service of Veterinary Surgeon's Office is to provide artificial insemination, veterinary medicine and disease prevention in the livestock sector. In a regional office, only 2-3 Livestock Development Officers are deployed and they have to cover the whole region in terms of artificial insemination. The regional level officers and dairy farmers explained that this service has to be expanded to achieve better production performances.

In addition to the above government and private sector organizations there are several institutes that help dairy farmers provide necessary training and other information required to practice better dairy husbandry. Accordingly, government farms, the Sri Lanka Sumurdhi Authority, Fontera milk processors, Industrial Development Board, Co-operative societies, Mahaweli Authority, CIC Agribusiness Private Limited and other institutes provide training and other support to develop the sector. However, lack of coordination among these institutes to ensure formal provision of training and knowledge is a drawback.

### **7.3 Trade and Tariff Policies**

According to Mendis and Edirisinghe (2014), in 1978, the tariff rate for the powdered milk was five percent whereas for liquid milk it is was 60 percent. In spite of the supply promotion policies of the dairy sector, it was allowed to import powdered milk at attractive prices. In addition, policymakers announced milk as an essential food in 2007 and all taxes and levies are removed to increase the milk consumption.

Therefore, the trend of milk imports is upward. This trend of importation progressed until the melamine and DCD issues emerged in 2014. With the melamine and dicyandiamide (DCD) issue, the focus changed to the domestic dairy production improvement and government has increased the price of imported powdered milk and increased the customs duty of powdered milk from Rs. 18 to Rs. 68 in February 2014 (Central Bank Annual Report, 2014). As described by the Central Bank reports (2018), the duty waiver was Rs. 175 and custom import duty was Rs.50. Altogether, for importation of one kg. of powdered milk, Rs.225 will be charged.

#### **7.4 Fiscal and Monetary Policies for Dairy Development**

Danial (2008) explains that there was a shortage of loan schemes to uplift dairy farmers. However, there were several dairy development loan schemes initiated with the support of the Central Bank. The regional Livestock Development Instructors noted that the utilization of such loan schemes was at a lower level and these loans were utilized for other family matters. Bank of Ceylon too introduced a commercial scale dairy development loan scheme in 2018 with the objective of increasing the milk production for established large scale (Mega) farms of more than seven cows and encouraging dairy value added activities. The maximum amount of loan was Rs, 25 million. Similar loan schemes were introduced by several financial institutions.

In addition to the national dairy grants, international dairy development projects are progressing continuously with the assistance of donor countries. US Dairy development project is one such project that provides financial assistance to dairy farmers to develop the small scale dairy industry. In addition, there are several NGOs assisting financially to enhance the dairy production in the country.

It is important to note that, even though government, non-government and other financial institutes focus on developing the dairy sector, there is no integration of these projects and development activities. Research proves that coordination of these projects and financial assets with all interested parties will be much beneficial and can be useful for the dairy development of the country.

Further, Sri Lankan government has allocated substantial funds for dairy development through national level projects and programmes implemented by the Department of Animal Production and Health: Heifer calf rearing programme, Dairy Village Development Project, Liquid Milk Promotion Programme, promotion of private breeding farms, continuation of dairy breeding project by providing facilities for artificial insemination, pasture development programme, milk cattle importation programme to upgrade the national herd to enhance milk production and development of Ridigama farm. In addition, Badulgama Milco processing unit was also established to enhance value addition. In a study conducted by the Hector Kobbekaduwa Agrarian Research and Training Institute (2009) it was found that the Dairy Village Development project was a success and following the project, milk production and the quality of the milk have increased. In addition, the dairy farmers stated that the heifer cow management project is a success and it contributed to

develop the dairy value chain by upgrading the nutritional standards of the heifers in the herd.

### **7.5 Liquid Milk Pricing Policy**

Usually the raw milk price is determined by the amount of fat and Solid Non Fat (SNF) levels of the milk. The collecting agents have adjusted the prices according to the levels of fat and SNF. Generally, higher fat level resulted in increased market prices. It is hard to find any scientific formulas to determine the price of raw milk. However, the production prices of raw milk was calculated by different dairy related organizations and government determined the price to protect dairy farmers. At present, for the cow's milk prices range between Rs. 65 to Rs. 75. However, the buffalo milk prices remain between Rs. 90 to Rs. 100.

### **7.6 Banning Slaughtering of Cow**

An important policy decision was reached in 1987, banning the slaughtering of cows and female buffaloes. This was basically due to decrease in national herd of the cattle. However, this policy did not result in increasing the national herd. Hence, the government imposed a ban on illicit transport of cattle and introduced heavy penalties. According to the Census and Statistics (2019), the total licenced slaughtering of cattle was 158,723. However, illegal slaughtering also takes place. According to a study conducted by Hector Kobbekaduwa Agrarian Research and Training institute, 2016, it was noted that stealing of animals for illegal slaughtering in Seethawaka area affected the farmer income and the milk production of the herds.

### **7.7 Dairy Farmer Insurance Programme**

The Agriculture Insurance Board has introduced some cattle insurance programmes. However, farmers are not much connected with these insurance programmes. The requirement of dairy farmer insurance scheme cannot be dismissed.

### **7.8 Importation of Dairy Cows**

According to the Ministry of Livestock Development (2019), in 2017, around 5000 cows were imported to the value of US\$2317 million and distributed to the farmers at Rs. 200,000 per animal. Farmers complained that the given animals are not producing the expected 20-25 litres per day but only producing 7-8 litres per day. In addition, it was reported that around 406 animals have died and some animals are highly susceptible to diseases. As per the Auditor General Department report, this is a failed project and it is an extra burden to the dairy farmers. Further, it was found that these breeds are misfits to the climatic conditions, produce poor milk yield, susceptible to diseases and have low conception rate. The responsible project officers claim that the importation of cattle from Australia fulfilled all requirements and both Sri Lankan and Australian authorities have checked the conditions of the animals as well. However, the animal management was problematic and officers said

that these animals did not receive required feeding and other management requirements. According to the Ceylon Today (2020), a similar project in Vietnam was successful because all the imported animals were managed in a largescale farm with close supervision and the second generation of these animals were distributed to the small scale farmers which better suited the climatic conditions of the second country.

Dairy development policies play a major role in uplifting the industry. Government and its instructional setup has taken several policy decisions towards this end. However, still Sri Lanka needs to focus on dairy sector development. The institutional setup should be strengthened and the sector needs more experts to the regional dairy development. Human resources need to be developed both in the primary and support activities as per the Porter's Value Chain. In addition, production target extension services in the institutional sector need to be increased. Further, policies should be formulated to enhance the domestic raw milk consumption while restricting the importation of powdered milk. The dairy animal insurance and dairy farmers' insurance schemes should be more attractive and made accessible for small farmers. Dairy development loans and other projects should focus on the farmers who struggle to survive in the industry.





## CHAPTER EIGHT

### Economics of Milk Production

In this chapter, the cost of production of a litre of milk was calculated. In addition, the cost of production of different products such as yoghurt, ice cream, milk toffee and other products were calculated at the small and medium scale situation. Further, Cobb- Douglas Regression Model is utilized to understand the input-output relationship of milk production.

#### 8.1 Cost of Production of Milk

Cost of production of milk was calculated inclusive and exclusive of family labour in the study area. Accordingly, the cost of production of one litre of milk is Rs.59.63 and the labour cost accounts for half of the total cost of production whereas feed costs account for 46 percent. Other than the above main cost categories, medicine, operational cost, breeding cost also account for a total of four percent.

**Table 8.1 Cost of Production with Labour**

Cost	Mean (Rs)	Percentage (%)
Cost of Feed	27.45	46
Labour Cost	29.85	50
Medicine Cost	0.57	1
Operational Cost	0.93	2
Breeding Cost	0.83	1
<b>Cost of Production with Labour</b>	<b>59.63</b>	<b>100</b>

Source: Survey Data, 2019

As described in Table 8.2, the average cost of production without labour amounts to Rs.29.78, Here the feed cost was calculated as 92 percent whereas the medicine cost, operational cost and breeding costs account for eight percent of the total cost.

**Table 8.2: Cost of Production without Labour**

Cost	Mean (Rs)	Percentage (%)
Cost of Feed	27.45	92
Medicine Cost	0.57	2
Operational Cost	0.93	3
Breeding Cost	0.83	3
<b>Cost of Production without Labour</b>	<b>29.78</b>	<b>100</b>

Source: Survey Data, 2019

Table 8.3 illustrates the cost of production inclusive and exclusive of family labour according to the number of milking animals in the herd. When the number of milking cows are between 1-3, the average cost of production exclusive of family labour is calculated as Rs. 26.30 whereas with family labour the cost of production is Rs.65.09.

The table explains that the milking animals with 3-6 in a herd demonstrate the minimum cost of production with family labour, which is Rs. 53.40. This indicates that to obtain the maximum benefit out of the labour it is appropriate to rear six animals in a herd.

**Table 8.3: Cost of Production According to Milking Cows**

Number of Milking cows	Cop without Labour	Cop with Labour	Profit Per Cow (Per Day)
1 – 3	26.3	65.09	64.415
3 – 6	27.59	53.4	103.68
6 <	32.25	60.9	56.4

Source: Survey Data, 2019

## 8.2 Cost of Production of Value Added Products

### 8.2.1 Curd Production

Curd is a popular delectable among locals and foreign visitors. Traditional curd producing systems are practiced, especially in the low country dry zone of Sri Lanka. In addition, wet and intermediate zone districts such as Gampaha, Colombo, Kurunagala that practice buffalo rearing are also famous for curd production. At present, both cow's milk and buffalo milk are utilized for curd production. However, traditionally, curd is produced using buffalo milk. Curd production can be introduced as a household industry because it does not require increased technical knowledge and equipment. It is noted that several families are engaged in curd producing industries at micro level and medium level curd producing plants with milk being collected from surrounding farms.

**Table 8.4: Cost of Production of Curd in Study Area (1 litre)**

Cost Item	Cost (Rupees)
Milk	81.59
Labour	08.03
Pot/Label	19.82
Operational cost	1.47
<b>COP /Curd</b>	<b>110.91</b>

Source: Survey Data, 2019

Table 8.4 illustrates the cost of production of a litre of curd pot which is Rs. 110.91. Generally, culture is needed to produce fresh curd and the culture is obtained from the produced curd. Therefore, there is no cost involved in obtaining culture. Curd is a profitable venture that most of the farmers are engaged in. Producers usually sell a litre of curd for Rs. 170 to traders and traders sell curd for Rs.220 to Rs.250. Small scale farmers produce 15 -20 curd pots whereas at medium level it is 100-200 curd pots per day.

### **Case study 01 – Hambanthota District – Thusitha Curd**

The owner of the Thusitha Curd is Mr. W.G. Thusitha Gamini, a traditional curd producer, living in the Hambantota district. His grandfather started the curd processing plant and they owned hundreds of buffaloes those days. However, at present there are about 150 animals in the herd. These animals are located at Kotiyagala and Siyambanduwa, which are far away from the processing centre. Mr. Thusitha mentioned that there is enough roughage in the jungle for the animals but water is lacking in the area. His own farm animal rearing is done extensively and there are two full time labourers involved in dairy farming activities. The farmer has built some cattle sheds for animals to rest at night and provide water facilities.

In the farm most of the animals belong to the breed Niliravi, yielding six litres of milk per day. In addition, he does not provide concentrate feeds to the animals. Accordingly, he is able to collect about 130 litres per day from his farm.

The daily milk requirement in his plant is 310 litres and he collects 180 litres from the surrounding farmers in Kotiyagala and transports to Hambantota. According to the fat percentage of the milk the price is determined. The collected milk is boiled to a certain extent and it prevents deterioration while transporting. He also mentioned that some of the producers use hydrogen peroxide arbitrarily to increase the shelf- life of the milk.

After transporting the milk on the same day, milk is boiled again and necessary steps are taken to produce the curd. In the processing centre a worker is employed full time. Mr. Thusitha produces curd pots:1250 ml and 1000 ml. Two curd pots produced on the previous day is utilized for culture for fresh curd production. He also added that they never use chemicals and it is possible to keep curd for one and half days without being refrigerated. If refrigerated, the curd can last for one week without spoiling.

The farmer also stressed that, at present he receives less profit than earlier. He only mentioned the expenditures needed to run the business. Accordingly, he spends for two workers in the farm Rs. 4000/= per day and for the worker at the processing centre Rs. 2800/= per day. However, the farmer did not mention the exact income from the industry. It is clear that farmer can run the system still with certain income.

He also mentioned that, the veterinary service he received for his industry is not sufficient. In addition, he mentioned the requirement of a grazing land in the area. Natural grazing is becoming difficult due to population increase and the increased cultivated land area. He also noted that curd processors and buffalo farmer's knowledge and experience should be enhanced by providing required training while protecting traditional practices. This traditional industry is facing difficulties such as finding grass, and roughage. At present it is impossible to rear animals extensively due to the changes of traditional systems. In addition, if there is a certified price for a litre of curd it is easy to run business. Further, he noted that intermediaries earn more money than the producers because they fix the prices to obtain higher incomes. Traditional buffalo farmers in the Hambanthota area tried to obtain a common grazing land. However, governments did not support this idea because farmers explained that one authority itself could not take decisions, as land ownership spreads across different government authorities. However, it is important to change the traditional system into a semi intensive or intensive systems to obtain better results for the farmers.

## 8.2.2 Yoghurt Production

Yoghurt production is not very common among Sri Lankan dairy farmers. A few farmers engaging in value added production are involved in yoghurt production.

**Table 8.5: Cost of Production of Yoghurt in Study Area (1 cup)**

<b>Cost Item</b>	<b>Cost (Rupees)</b>
Milk	6.40
Labour	0.07
Pot/Label	7.10
Operational cost	0.41
<b>COP / Yoghurt</b>	<b>13.98</b>

Source: Survey Data, 2019

As shown in Table 8.5, the cost of production of a cup of yoghurt is Rs. 13.98. The cup, label and culture incurred more than half the cost. Usually a cup of yoghurt is sold to the traders for Rs.18 to Rs. 22. However, in the market the price is RS. 35/= . Selling yogurt is highly profitable for the trader. However, small scale manufacturers complain that production of yoghurt is not profitable as they have to compete with multinational companies.

In this study, a few yoghurt producers from the Gampaha district were interviewed; Mihiri farm, Snak Farm and Aththanagalla Cooperative Milk Society. In addition, in the Hambanthota district Ruhunu Mahaweli Milk Processor also produces yoghurt at medium level. The processors explained that it is possible to produce 10-12 cups of yoghurt from a litre of milk. Accordingly, the total cost of production for 10 yoghurts is Rs. 139.80. However, producer sells one yoghurt for Rs.20.00-22.00. If they sell one at Rs. 20.00. Farmer would earn RS. 279.60 per ten cups. The producer's profit is 139.80. Therefore, the yoghurt industry is profitable to the producer as well. However, traders sell a cup of yoghurt for Rs. 35.00 and traders earn more profit than the producers.

### Case Study 02 - Mihiri Farm – Mirigama

Mr. N Wijewardene started the Mihiri farm 30 years ago. They produce yoghurt, yoghurt drink, milk buddy packets, iced milk packets, and flavoured milk. Mr. Wijewardene explained that earlier there were 60 workers employed in his company and at present the number of workers have been reduced to six. He argues that successive governments have not been supportive to the domestic small-scale milk processors. Small processors need to compete with multinational companies to sell their products. Mr. Wijewardene is highly disappointed with the present support system of the government and he explained that multinational companies receive much benefits and support than the small-scale producers to run the business.

This small scale producer tries to produce good quality dairy products to the market and he maintains standards of milk processing while helping surrounding farmers by purchasing the raw milk from them. Mr. Wijewardene said that All Island Small-scale Dairy Producer Association has discussed their problems with earlier governments, but to no avail.

Mr. Wijewardena also added that all mechnes needed to this industry have to be imported and there is no mechanical support to enhance milk processing. It was stressed that providing formal training to improve the dairy processing is essential. All in all, the owner of Mihiri farm requested the government to support and subsidize to uplift the small scale dairy producers of the country. Low market recognition, high competition and increased cost of production are major challenges in maintaining these small scale industries.

### 8.2.3 Ice-cream Production

Commercial producers are mainly engaged in ice cream production. According to the case study, the cost of production for a litre of plain flavoured ice cream is Rs. 83.48. However, they sell a litre of ice cream for Rs. 180.00 to Rs. 350.00 depending on the quality and the brand name of ice cream in different markets. The brand name ice cream determines the price of product and it is a profitable venture.

**Table 8.6: Cost of Production of Ice-cream (1 Litre)**

Cost Item	Cost (Rupees)
Milk	35.00
Labour	5.78
Pot/Label	41.80
Operational cost / electricity	0.9
<b>COP / Ice-cream(1litre)</b>	<b>83.48</b>

Source: Survey Data, 2019

### 8.2.4 Milk Toffee

Milk toffee production is popular among rural women. In the Kandy district, there is a well-established milk toffee producer, and she has become the best entrepreneur in the small-scale processing sector and the Department of Animal Production and Health has awarded several certificates and extended support to her in developing the industry. The cost of production of a piece of milk toffee was Rs. 1.97. However, the wholesale price is Rs. 4.00 per piece and in the retail market it is Rs. 6.00. Milk toffee has a high demand from small teashops.

### 8.3 Dairy Farming as an Enterprise

At present, majority of the dairy farmers are engaged in dairy farming as a secondary source of income generating activity. If it is their priority income generating activity, farmers will be more engaged in and the production performances can be increased. A minimum of Rs. 62,237 monthly expenditures are required for household activities (Mean household income per month- Household income survey 2016).

Mean household expenditure per month= Rs. 62, 237.00

Cost of production of milk without labour = Rs. 29.78

Average milk price/ litre = Rs.64.00

Daily milk production needed to obtain Rs.62,237.00 per month = 66 litres of fresh milk

To obtain a year-round stable income, it is essential to monitor the stage of lactation of animals in the herd.

**Table 8.7: Milk Yield as per the Stage of Lactation**

Stage of Lactation	Start	After 2 months (Peak)	After 4 Months	After 6 Months	After 8 Months	After 10 Months	Dry Stage	Total
Number of Cows	2	2	2	2	2	2	2	14
Milk litres Per day	3	8	7	6	5	4	0	
Total	6	16	14	12	10	8	0	66

The 8.7 illustrates the milk yield and the stages of lactation that need to be maintained in a herd. Accordingly, the total number of milking animals should be 14 in a herd in different stages of lactation. As shown in the lactation curve derived from Bouallegue and Hamdi (2019), it is evident that at the peak lactation (after 2 months of calving) milking cows produce the highest amount of milk and in this model, it is assumed that cows produce eight litres of milk per day and the yield is slowly reducing over time. In the model there should be two milking cows in each stage on the assumption that each cow produces the same amount of milk.

Therefore, to execute an economical dairy farming unit it is necessary to have 14 milking cows in a herd belonging to different stages in the lactation curve.

### Lactation Curve

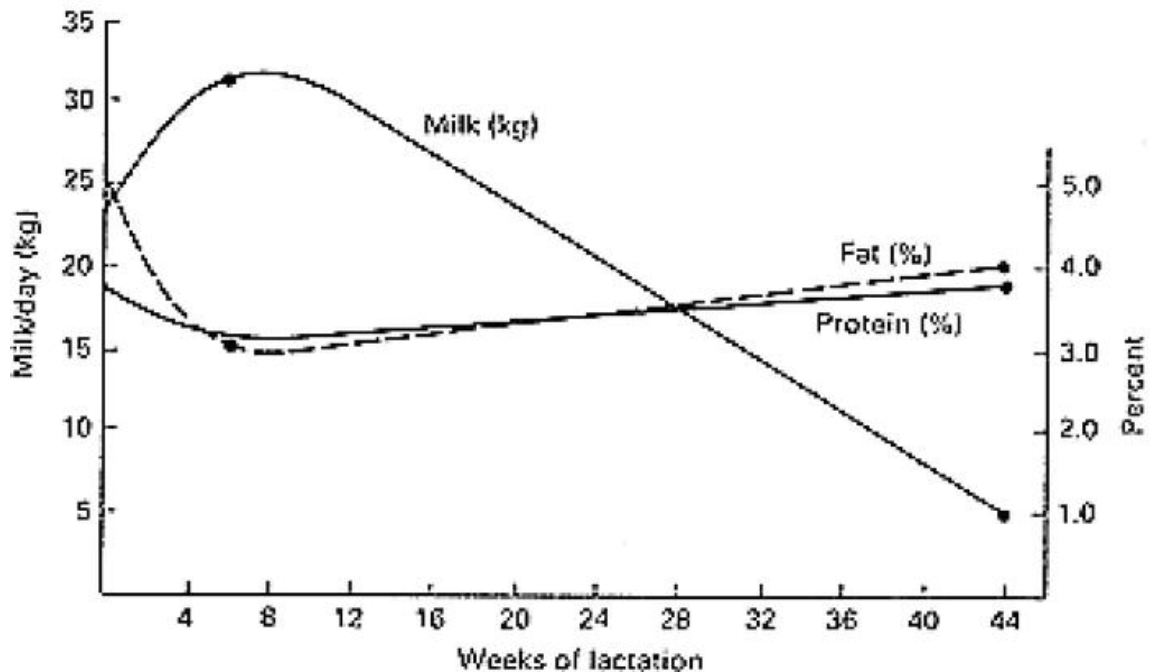

Source: Bouallegue and Hamdi (2019)

### 8.4 Cobb-Douglas Production Function

Cobb-Douglas Production Function is a common function used in agricultural and livestock sectors to understand input - output relationship. It is linear in its logarithmic form and convenient in computer analysis.

The following Cobb-Douglas function (1) fitted to the data in its log-linear form (2)

$$Y = AX_1^{b_1} X_2^{b_2} \dots X_{10}^{b_{10}} e^u \quad (1)$$

$$\ln Y = A + b_1 \ln X_1 + b_2 \ln X_2 + \dots + b_{10} \ln X_{10} + u \quad (2)$$

Where Y is the dependent variable and  $X_1, X_2, X_3, X_6, X_7, X_{10}$  represent the different independent variables and the  $b_1, b_2, b_3, b_6, b_7, b_{10}$ , are the partial elasticities of different independent variables.

#### Dependent Variable

Y = Milk production – litres / herd /day

#### Independent variables

$X_1$  = labour hours / herd /day;

$X_2$  – Amount of concentrate feed = kg/herd/day;

$X_3$  – Cost of veterinary and medicine (Rs/herd/day); (It was assumed that in study area, price of a particular medicine is considered as same price)

$X_6$  – Fixed cost (Rs/Farm/day); (Depreciation also considered as same values)

$X_7$  – Breed type (improved=1, local=0)

$X_{10}$  – Management type (intensive=1, extensive=0)



According to the Cobb-Douglas analysis of the data collected from the study the following regression model is derived.

Coefficients						
Model		Unstandardized Coefficients		Standardized Coefficients	t	Sig.
		B	Std. Error	Beta		
1	(Constant)	.837	.100		8.381	.000
	LN_X1	.414	.037	.490	11.036	.000
	LN_X2	.073	.014	.202	5.089	.000
	LN_X3	.040	.019	.085	2.114	.036
	LN_X6	.085	.010	.391	8.892	.000
	LN_X7	-.047	.059	-.031	-.795	.428
	LN_X10	.042	.060	.027	.691	.490

a. Dependent Variable: LN\_Y

Estimated Regression model is

$$\ln(Y) = 0.837 + 0.414 \ln(X1) + 0.73 \ln(X2) + 0.04 \ln(X3) + 0.085 \ln(X6)$$

Model Summary				
Model	R	R Square	Adjusted R Square	Std. Error of the Estimate
1	.860 <sup>a</sup>	.739	.731	.37342

As shown in the model summary 73.9 percent of the variance in the data can be explained by predictor variables.

The model helps understand how much each variable contributed to increase the milk production. Accordingly, above regression model explained that, amount of labour, amount of concentrate feed, cost of veterinary and medicine and fixed cost significantly affected the milk production. However, breed type and management type did not significantly influence the milk production according to the model. In general, breed type and the management type should have a significant influence on the milk production. However, in the study area, there is no significant effect of breed type on improved and local breeds. Further, the management type, also should have a significant effect. However, it may be due to lack of practice of better management practices. Even though in the study, we identified the system as intensive, semi intensive or extensive, the feeding of nutrient rich feed may be restricted. This problem was investigated in the field level and it was observed that correct feeding was not being practiced. Therefore, breed type also did not have a significant influence on the milk production.

The assumptions and the suitability of these test results are presented in Annex 02.

## **CHAPTER NINE**

### **Milk Value Chains of Study Area**

This chapter describes the milk value chains of the different districts of the study area — Gampaha, Kandy, Anuradhapura, Nuwara-Eliya, Kurunagala and Jaffna. In most districts, Milco collects the highest percentage of milk and in other districts like Gampaha Cargills Dairies collect the highest amount of milk while in the Jaffna district, YALCO and LIBCO are the leading milk collectors. However, Milco and Nestle also try to get established in these areas.

#### **9.1 Gampaha District**

As shown in Chart in the Gampaha district 25,470 liters of milk are collected per day. The main collectors such as Milco, Cargills, Nestle and Aththanagalla Co-operative collect altogether 54 percent of the total milk whereas the rest of the milk is collected by other collectors such as private processors and direct consumers. From the main collectors Cargill's Dairies collects 51 percent of the milk and Milco collects 26 percent. Aththanagalla milk Co-operative system also collects five percent for value addition. Milco produces milk powder and other value added products such as yoghurt, curd, ice-cream and fresh milk or liquid milk. Consumers obtain those products under different trade names.

Gampaha District

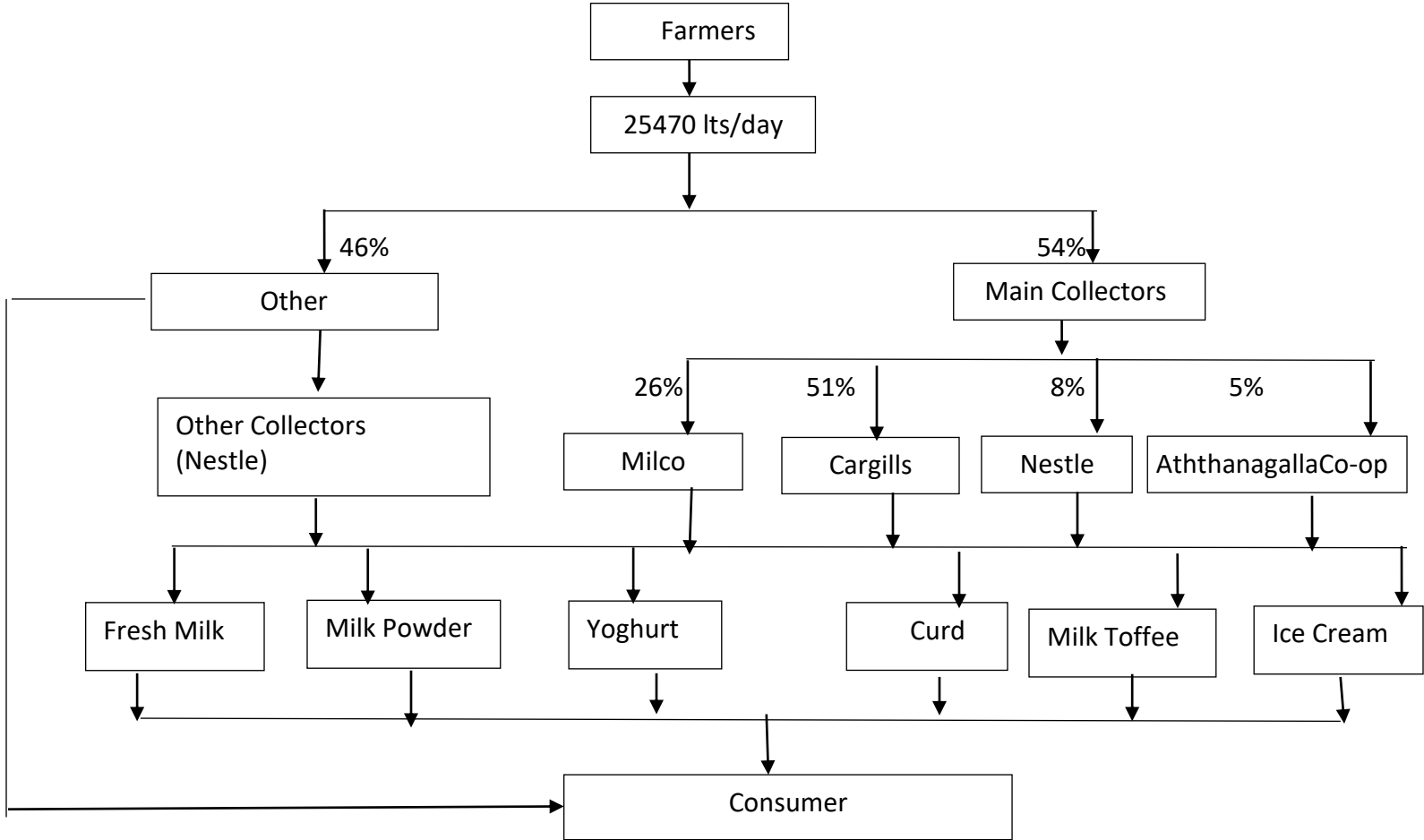

## 9.2 Kandy District

The total milk collection in the Kandy district is 53,110 liters per day. The formal collection covers 81 percent of the produced milk whereas 19 percent is collected from the informal sector. In the formal sector, Milco collects 58 percent of the milk whereas Cargills 26 percent and Nestle 16 percent of the milk. These processors also produce value added products such as yoghurt, ice cream and curd. The informal collectors collect milk and engage in producing value added products.

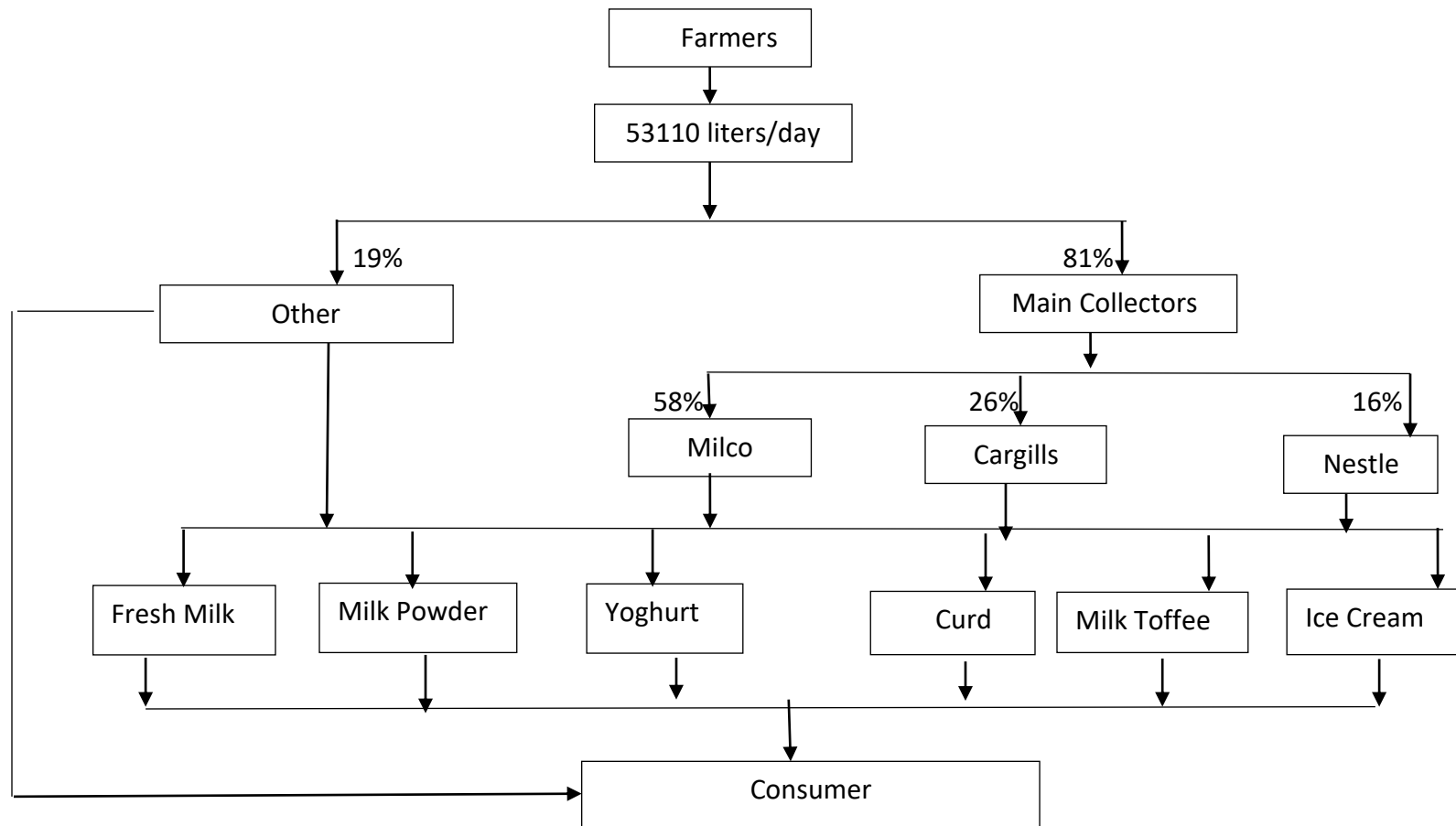

### 9.3 Kurunegala District

In the Kurunegala district the total daily collection of fresh milk is 130,030 per day. The formal collection consisted of the collectors such as Milco, Cargills, Fonterra, Nestle and Coconut Triangle Milk Union (CTMU). Of the main collectors 40 percent of milk is collected by Cargills. In the district, informal collection was 32 percent and all the processors produce value added products and forward to the consumers.

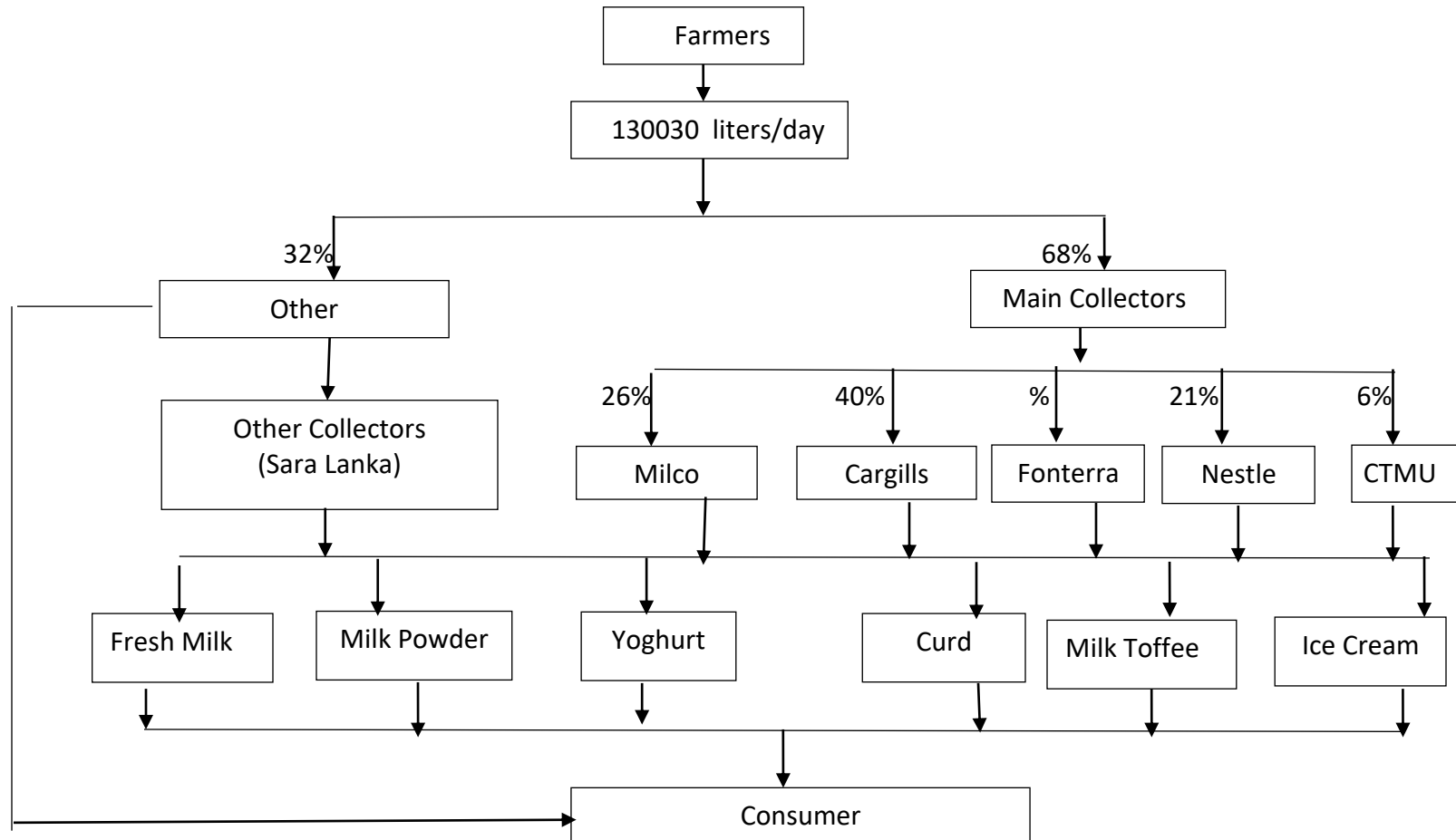

#### 9.4 Anuradhapura District

In the Anuradhapura district daily milk collection was 74,700 liters. The main collectors are Milco, Cargills, Richlife, Nestle, Eppawala Co-operation and CIC Dairies. Milco collects the highest amount of milk in the district. In the informal sector one fifth of the district's daily production is collected and this includes direct selling to nine small processing centers.

In the district, in the area Galenbidunuwewa the small scale milk processor Himali dairies is a well-established small scale enterprise which helps women with low economic level by providing them employment in the company and it has received awards for dairy production.

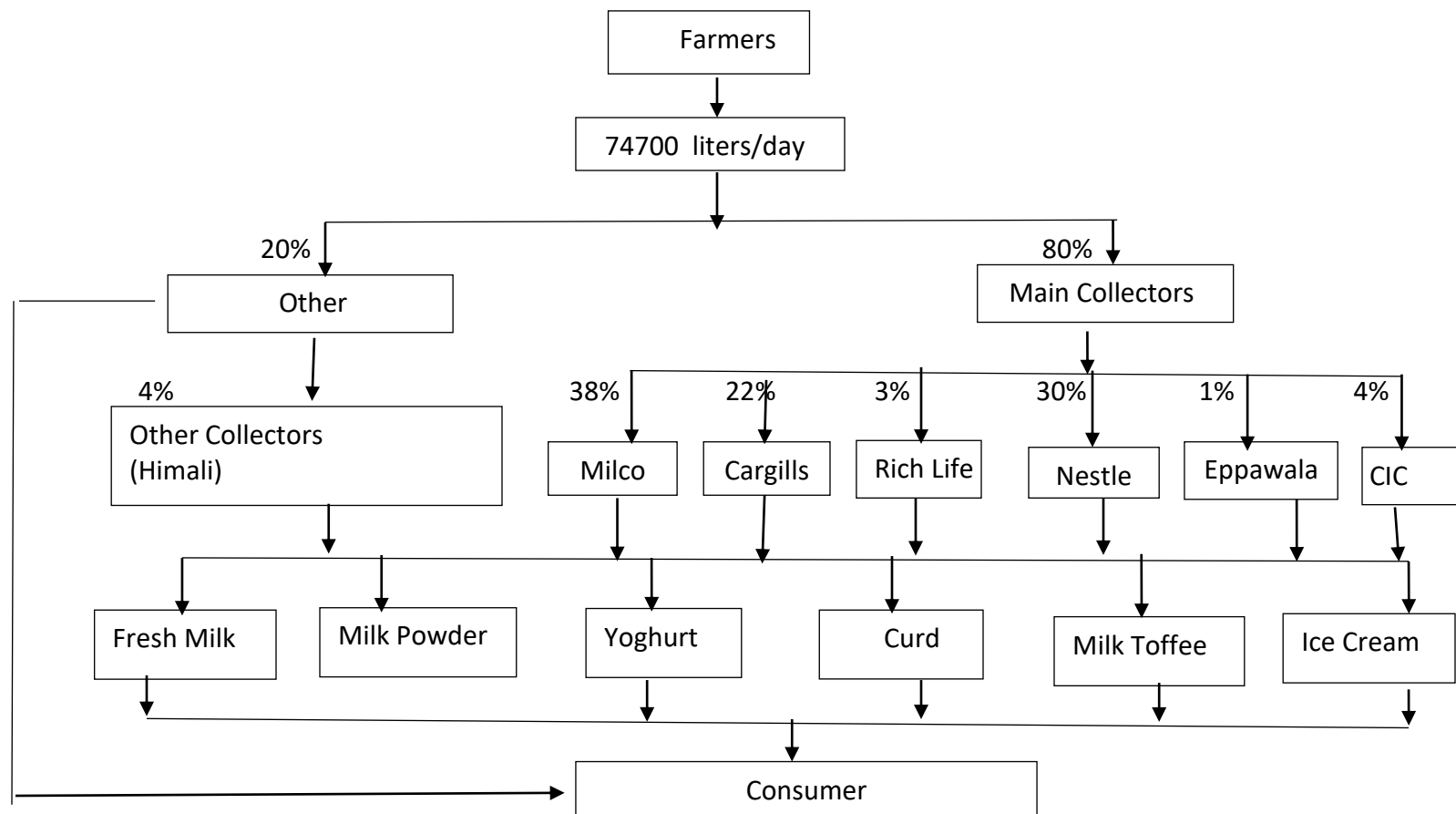

## 9.5 Nuwara Eliya

In the Nuwara Eliya district the total daily production was 156,560 litres and 48 percent is collected informally and the formal collection was 52 percent. Milco collects 40 percent from the main collectors and Cargills collects 30 percent while Palawatta also collects 19 percent. These companies produce value added products and send to the market.

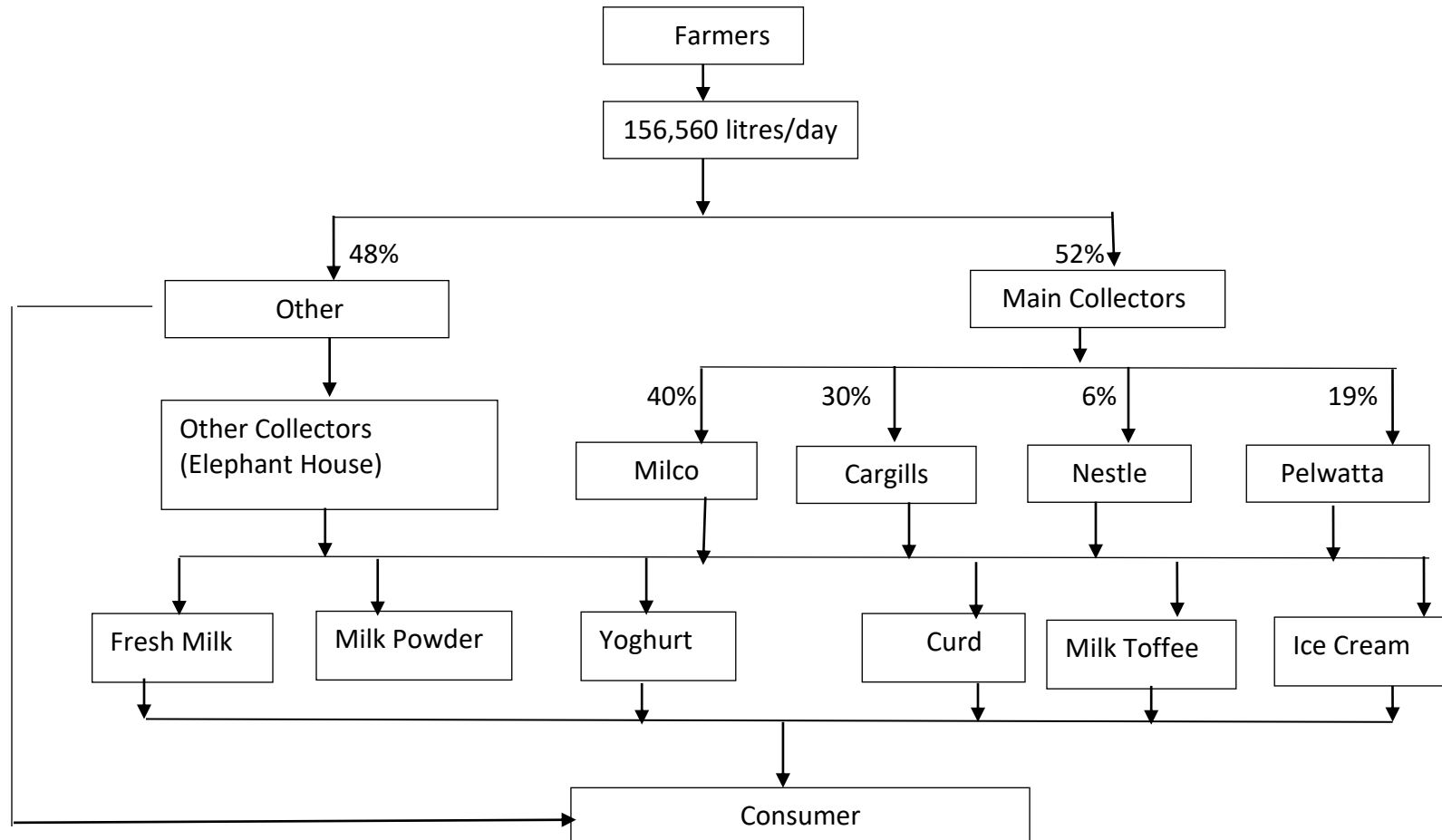

## 9.6 Jaffna District

In Jaffna, district average daily milk collection is 46,500 liters. The main collectors involve Milco, Cargill's, Nestle, YALCO and LIBCO. The formal network collects 87% of the milk whereas informal sector collects 13% of the milk from the total collection, 42% of milk is collected by Nestle, whereas Milco and Nestle collects 17% of the formal collection. In Jaffna YALCO and LIBCO are also popular collectors. However, YALCO collects 22% of the formal collection and LIBCO covers 2% of the formal sector. In Jaffna district, famous value added products are paneer and in the festival season fresh milk is highly demanded in the area.

The labour cost accounts 50% of the total cost of production and feed cost accounts 46% of the total cost. However, without family labour cost in cost of production, 92% of the cost accounts feed cost.

Therefore, animal feed cost influence directly to the milk production. In the market the price of Prima dairy feed, poonac and other concentrate to feed is more than Rs.60.00 per Kg. In addition, farmers believe that, without concentrate feed they can't increase milk production. Therefore, educating farmers to provide adequate roughages and water is important. In addition, it is important to maintain reasonable feed price by introducing subsidizing price. Increase of the availability of rice brand and coconut poonac is also important.

In the production sector, providing good quality grass is a limiting factor due to land constraints in growing private grasslands. Most of the small-scale farmers do not own any land for grass cultivation despite having land for themselves. They tend to grow agricultural products to obtain a better return. Further, in the study it was revealed that obtaining common grassland also problematic due to land acquiring challenges. However, if suitable lands for grass cultivation is identified it is possible to maintain common grasslands.



Jaffna District

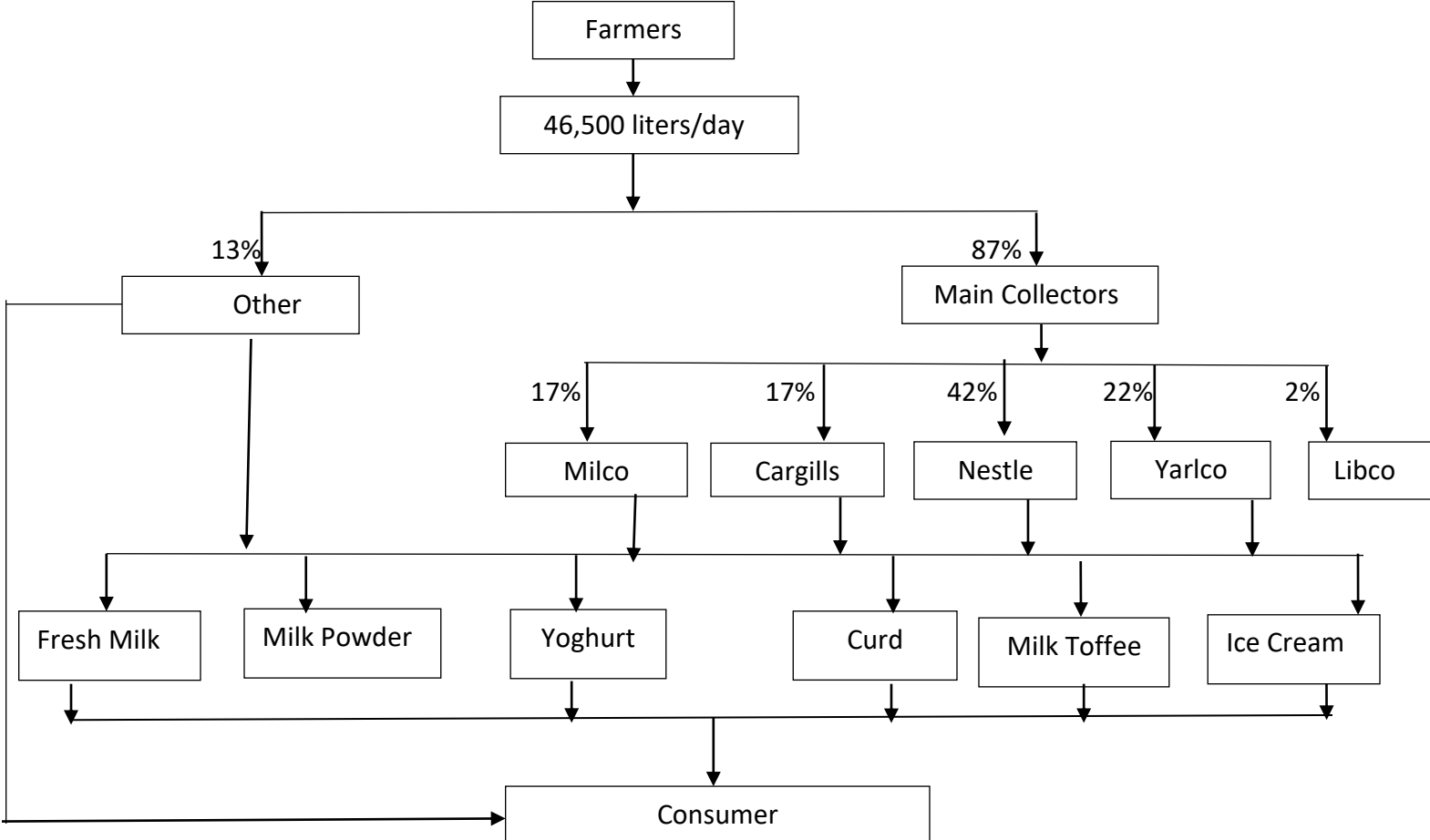

## CHAPTER TEN

### Value Chain Gaps and Suggestions for Improvement

This chapter explains the value chain gaps and suggestions to improve the value chains of the dairy industry.

#### 10.1 Production Sector

In the Sri Lankan dairy sector, most of the farmers produce milk in the farms mostly it is sold as raw milk. The cost calculated to produce a litre of milk including family labour is Rs. 59.63 and without family labour, the cost is Rs. 29.78. The total labour cost accounts for half of the total cost and the concentrate feed accounts for 46 percent of the total cost. The study revealed that most of the small-scale farmers rely on the family labour and in the large-scale farms, obtaining hired labour for the dairy industry is challenging. The youth involvement in the dairy sector is also at minimum level. Most of the farmers said that there is no social value for the dairy industry at the small-scale village level. In addition, due to the lack-lustre in the existing programmes the youth are drifting away from the industry. As described the increased cost of production can only be reduced by cutting down the feed and labour costs. At present livestock feed ingredients are imported and the cost of feed ingredients are high. Therefore, increasing the maize production within the country is important. Dairy farmer social development programme is essential to motivate the dairy farmers and attract new farmers to the industry.

Finding quality grasses for the dairy industry is challenging. Most of the farmers do not own large plots to develop their own grasslands. Farmers most likely rely on the road side grass and common lands. Therefore, finding quality forage which support improving the milk production is also problematic. Most of the farmers stressed the importance of common grasslands that should be managed by village level Dairy Farmer Managing Societies. In addition, it is important to understand the amount of feed required for each animal. It is also important to introduce technology and facilities for hay and silage making. That will ensure consistent feeding during the lean periods for the animals. According to the Sri Lankan climatic conditions, natural grass availability is greater in the rainy season. In these periods, farmers should engage in hay and silage making.

In the sample population majority of the farmers expressed that they used well water for the dairy production. This may affect the sanitary condition of the herd and the production performances of the animals. Therefore, adequate water supply is essential for better milk yields and clean milk production. According to Porter's Value Chain Concept, under support activities, improvement of infrastructure is paramount and this will increase the efficiency of milk production both in terms of quality and quantity.

Providing concentrate feed is the costliest operation in dairy farming. Farmers complained that it is unaffordable. However, most of the milk collecting agents

provide cattle feed on credit basis and they deduct the cost from the farmers' milk earnings. This is a good opportunity for the farmers. In addition, educating farmers on the correct usage of concentrate feed is also crucial. As per Porter's Value Chain Concept, in the primary activity input distribution is a basic activity. However, due to increased price, farmers are unable to provide correct concentrate feed. Therefore, to increase the value chain efficiency, concentrate feed price should be reduced or development of locally available feed and making them available for the farmers is essential.

Further, educating farmers on using modern grass cutters, grass chopper and technologies such as feed mixing and feed presentation to the animals also increase the milk production and efficiencies of milk production. Further, it will reduce feed wastage.

Artificial Insemination is the common method of breeding in the study area. However, some farmers use bulls from the farms to inseminate their animals. The AI service is functioning successfully but in the Jaffna district a few areas lack AI services. In addition, farmers complain that AI services are not available on holidays. Further, when animal becomes sick on holidays it is difficult to get the veterinary services. Therefore, it is important to establish a 24 hour on call veterinary service unit in dairy dominant areas. In addition, to increase milk production efficiency, introduction of sexed semen is essential and farmers also stressed the importance of sexed semen. It was noted that farmers are willing to pay more for artificial insemination done using sexed semen.

It is noted that finding high yielding animals are hard and challenging. Further, there is no authorized body to guarantee good animals to start dairy farming or expand the dairy farming with new animals. Therefore, it is crucial to maintain databases regarding high yielding animals and a mechanism to sell these animals to the dairy farmers. Further, it is important to introduce private breeding farms that enable farmers to buy the animals. Further, importation of milking cows for direct distribution to the farmers is a failure and the Auditor General's Department has also concluded that the project has not benefited the farmers but an extra burden. However, In Rideegama farm, with advanced management conditions, these animals are capable of producing better yields. However, a similar project has become successful in Vietnam, because they managed these animals with high care and second generation of the cows with higher adoptability to the climatic conditions were distributed to the farmers. Therefore, F2 generation of imported cows may give better results than the breeder animals under local conditions. In addition, most importantly, as recommended by the DAPH upgrading programme needs to be prioritised.

The study reveals that 57 percent farmers engaged in dairy farming semi-intensively and other farmers manage their herds intensively and extensively by 26 and 16 percent respectively. However, some systems such as extensive buffalo rearing systems are difficult to maintain with the present land scarcity issues.

The study shows that 83 percent of the farmers maintain some form of cattle sheds for the animals. Farms adopting intensive and semi intensive methods of rearing maintain cattle sheds. However, most of the cattle sheds need to be developed with correct floor space for animals, having waterers and feeders with the recommended space, bedding materials, ventilation and animal protection. Providing these requirements will reduce the stress of animals, which in turn may increase the milk production. Therefore, according to Porter's value chain to increase the production efficiency within the farm, standard cattle shed development is needed.

Farmers complained about animal theft especially in the Gampaha and Kurunegala districts. It is a huge loss to the farmer if they lose their high producing animals because the price of animal is well above Rs. 100,000/-. Therefore, it is important to introduce new technology to track animals at night as well. In Kenya chip safer technology is used to update users on their livestock location in real time. This works by using receivers five to twenty miles apart. This is equipped with GPS and accelerometers. The sensors transmit data about livestock location, speed and movement pattern of livestock via satellite (Quartz Africa, 2018).

## **10.2 Marketing Sector**

The simplest form of value chain is milk produced in the farm and selling to the village level collectors as raw milk. The dominant milk collectors are Milco, Richlife, Nestle, Palawatta, Co-operative societies, Fonterra, private collectors and LIBCO and YALCO in the Jaffna district. Based on the fat and solid nonfat content of the milk different companies have varying pricing formulas for the milk. The existing milk-marketing network is highly competitive and milk collection agents have introduced welfare policies to the farmers who are organized as dairy farmer managing societies.

## **10.3 Milk Processing**

As per the study only six percent of the total sample farmers are engaged in dairy processing. All other processors collect milk for processing and run large scale and medium scale processing plants. Farmers engaging in processing mostly carry it out at small-scale level and it was noted that curd and milk toffee producing dairy farmers were also observed in the sample.

The cost of production of yoghurt is Rs. 13.98 in the smallholder production and in the market, a cup of yoghurt is sold at Rs.35/=. There is a high-profit margin for traders. A farmer sells a cup of yoghurt to traders for around Rs. 19/= to Rs 20/=. However, the small-scale yoghurt producers face difficulties in marketing their products with the competition posed by mega-companies. Therefore, it is important to protect small scale processors by promoting domestic products and educating the consumers of buying local products. In addition, quality assurance of the products is also important.

The cost of production for a litre of curd amounts to Rs. 110. However, depending on the trader, the price managing varies from Rs. 150–250/=. Production of value-added products is a profitable venture but farmers are unable to join the system due to financial problems and marketing competitions with large-scale companies.

Most of the small scale and medium scale processors produce small milk iced packets. This shows higher sales among school children and it is profitable as well.

It was noted that collecting milk is highly competitive in the lean milk production periods. Therefore, processors stressed the importance of having a year round production of raw milk that required for their production process. To maintain year-round milk production provision of good quality feed and correct nutrition supply is important. Therefore, it is important to formulate feeds with locally available resources.

According to the Porter's Value chain theory, in the primary activities, milk collecting, processing and distribution was carried out by the milk collectors. The collectors follow their own pricing mechanism and facilities for milk collection, transport and value addition. Milk production efficiency has been increased by different collectors providing essential inputs and knowledge to enhance the quality of milk. In addition, under primary activities, milk collectors ensure the improvement of increased the milk storage and transport facilities. Further, these milk collectors engage in milk processing and distribution and they produce different value added products and increase the profits of the industry by diversifying the products, Furthermore, the informal collectors are also engaged in value addition and they make more profit by making, ice-cream, yoghurt, curd and specially the iced milk packets. However, the quality assurance of these products is crucial because these products are much popular among school children.

#### **10.4 Consumers**

Milk consumers can be categorized according to the household income levels. Most of the low-income families tend to consume powdered milk than fresh milk. Most of the general population understand the importance of fresh milk consumption. However, except in the super markets there is no fresh milk marketing network and the fresh milk available in the super markets are expensive for the middle and lower income families. Therefore, direct marketing of fresh milk is important. It was noted that in the urban and peri-urban areas there is a high demand for fresh milk. Therefore, introducing door-to-door milk marketing network will benefit both consumers and producers alike.

At present, consumers show higher preference to purchase domestically produced milk powder and other processed products (HARTI, 2014). It is noted that, there is a high demand for Highland and Palawatta milk powder. However, to meet the demand the supply is not adequate. Therefore, it is important to invest more on the expansion of the production possibilities.

It was noted that the dairy development policy has changed with the change of political rule. At present, the Ministry of Agriculture has formulated national dairy development policy and is awaiting cabinet approval. In addition, the Vistas of Prosperity and Splendour Policy document proposes to increase the infrastructure facilities in the dairy farmers, other support services and input provisions. However, it is important to expand extension programmes and improve the quality of services by the government and private sectors. The quality of imported milk should be checked and import restrictions should be imposed to protect the consumers. In addition, the available dairy farmer loan schemes are not utilized and those schemes are difficult for the farmers to access. Therefore, to increase production efficiency, a quality input distribution mechanism should be implemented with reasonable price. Further, collectors and processors complained about mixing of different substances in the milk to achieve higher milk prices. Therefore, easy and advanced milk testing is needed before purchasing the raw milk.



## CHAPTER ELEVEN

### Conclusion

The study reveals that milk production is a profitable venture and if farmer wants to start dairying as a sole income generating activity, there should be 14 milking cows in a herd at different lactation stages.

Labour cost accounts for half of the total cost and concentrate feed cost accounted for 46 percent of the total cost.

The cost of production of small scale dairy farms with 3-6 milking animals in a herd accounts for Rs.53.40 per litre. Therefore, for small scale milking farms 3-6 milking animals in the herd is the ideal number.

Cobb-Douglas Production Function illustrates the input - output relationship of milk yield. Variables such as labour hours per day, amount of concentrate feed kg/day, cost of veterinary and medicine RS per day, and fixed cost RS per day are significant for the milk production. However, breed type and the management systems did not significantly relate to the milk production.

Milk processing is a profitable industry. Ice-cream production shows the highest profit margins and all other products return higher benefits and higher demand in the market. The small scale yoghurt producers face difficulties when competing with the multinational companies. Therefore, promotion of local products and small scale producers is essential and testing the quality of all the process products are important.

More than half of the sample farmers practiced semi intensive type of management of cattle farming. The extensive systems are threatened in low country dry zone, specially the traditional curd industry. Therefore, it is important to educate farmers and support them to shift from extensive to semi intensive systems for enhancing the milk production and protect the environment.

The input gaps such as feed cost, knowledge gap of farmers, low attraction of farmers, veterinary services and medicine, breed availability, quality grass production, grass preservation and other problems should be addressed to increase the milk production of the country.



## References

- Achchuthan, S. & Kajanathan, R., (2012), 'A Study on Value Chain Analysis in Dairy Sector Kilinochchi District, Sri Lanka', Global Journal of Management and Business Research, Global Journals Inc. (USA).
- Asian Development Bank, (2012), 'Support for Agriculture Value Chain Development', Independent Evaluation., ([www.adb.org/evaluation](http://www.adb.org/evaluation)).
- Austin, J.E. Associates, (2018), 'Methodological Guide', The World Bank, Viewed on 30<sup>th</sup> September.
- Berg, T.V.D. Eldurs, L. Zwart, B.D. Burdorf, A., (2008), 'The Effects of Work- related and Individual Factors on the Work Ability Model: A Systematic Review', Occupation and Environmental Medicine., researchgate.net.
- Bouallegue, M. Hamdi, N.N., (2019), 'Mathematical Modeling of Lactation Curves: A Review of Parametric Models', Intechopen.com.
- Bush, T. (2016), 'What is Bargaining Power in Business', ESTLE, [pestleanalysis.com/bargaining-power-in-business/](http://pestleanalysis.com/bargaining-power-in-business/)
- Central Bank Annual Report, 2014.
- Central Bank Annual Report, 2018.
- Central Bank Annual Report, 2018.
- Ceylontoday.lk, Importation of Aussie Cows: Wrong Breed for Wrong Climate, CEYLON TODAY.
- Chait, J, (2020), 'What are Value Added Products', The Balance Small Business.
- Chandrasiri, A.D.N. (2002), 'Country Report on the State of Animal Genetic Resources, Sri Lanka', The Food and Agriculture Organization of the United Nations.
- Chengappa, P.G., (2018), 'Development of Agriculture Value Chains as a Strategy for Enhancing Farmers Income', Agriculture Economics Research Review, 31 (1), PP. 1-12.
- Christopher B. (2008), 'Smallholder Market Participation: Concepts and Evidence from Eastern and Southern Africa', Food Policy, 33, (4), pp. 299-317.
- Co-operative in Ada'a District' Hall Larenstein University of Applied Science.
- Debele, G. (2012), 'Analysis of Milk Value Chain the Case of ADA'A Dairy

- Delgoda, C.L., (2003) 'Animal Source Foods to Improve Micronutrient Nutrition and Human Function in Developing Countries, Rising Consumption of Meat and Milk in Developing Countries has Created a New Food Revolution', International Food Policy Research Institute, Washington.
- Department of Animal Production and Health, 2017.
- Department of Census and Statistics, 2019.
- Harrison, K. (2019), 'What is Value Chain Analysis Business' newsdaily.com
- Hellin, J. and Meijer, M. (2006), 'Guidelines for Value Chain Analysis', Food and Agriculture Organization of the United Nations (FAO), Rome, Italy.
- Hitihamu H.M.S.J.M., Lurdu, M.D.S., (2016), 'Investigation of Peri- Urban Dairy Production System in Seethawaka Area', Hector Kobbekaduwa Agrarian Research and Training Institute, Colombo, Sri Lanka.
- <https://economicpoint.com/production-function/cobb-douglas>  
<https://www.oecd.org/sti/ind/interconnected-economies-GVCs>
- Ibrahim, M.N.M., Stall, S.J., Daniel S.L.A., Thorpe, W. (1999), 'Appraisal of the Sri Lanka Dairy Sector', Vol. 2, Main Report. Colombo, Sri Lanka.
- Jordan, H. Grove, B. Backeberd, G.R., (2014), Conceptual Framework for Value Chain Analysis for Poverty Alleviation among Smallholder Farmers, Agrekon: Agricultural Economics Research Policy and Practice in Southern Africa. 53: 1, pp. 1–25. DoI. 110, 1080/ 03031853, 2014 887903.
- Jurevicicius, O., (2013), 'Value Chain Analysis Strategic Management',  
<https://strategicmanagementinsight.com/tools/value-chain-analysis.html>.
- Kamar, D. and Rajeev P.V., (2016), 'Value Chain: A Conceptual frame Work', International Journal of Engineering and Management Sciences vol. 7, PP 74 – 77 [www.scienceandnature.org](http://www.scienceandnature.org).
- Kanu, B.S., Salami A.O., Numasawa K., (2014), 'Inclusive Growth – An Imperative for African Agriculture', African Development Bank Group, Tunisia.
- Kaplinsky R. and Mornis M., (2002), 'An Important Health Warning or A Guide for using this Hand Book', researchgate.net.
- KIT and IIRR., (2010), 'Value Chain Finance: Beyond Microfinance for Rural Entrepreneurs. Royal Tropical Institute, Amsterdam; and International Institute of Rural Reconstruction', Nairobi.

- KIT, Faida Mali and IIRR, (2006), 'Chain Empowerment: Supporting African Farmers to Develop Markets', Royal Tropical Institute, Amsterdam; Farida Market Link, Arusha; and International Institute of Rural Reconstruction, Nairobi.
- Mendis, S. Edrisinghe, J.C., (2014) , 'Milk Powder Imports and Government Policy: The Case of Sri Lanka', *Journal of Agriculture Economics and Rural Development*, PP. 86–91.
- Michael Porter, *The Value Chain from Competitive Advantage*, Viewed 01.10.2018.
- Miehael, L.L., Dan, N.W., (2007), 'Water for Dairy Cattle' Cooperative Extension Service, Collage of Agriculture and Home Economics, Guid D–107.
- Ministry of Livestock and Rural Development, 2019.
- National Research Priorities on Livestock and Poultry, (2017-2021), CARP Sri Lanka.
- Nuts, N. and Sievers, M., (2015), 'A Rough Guide to Value Chain Development: How to Create Employment and Improve Working Conditions in Target Sectors', International Labour Organization, Geneva. [www.ilo.org/valuechains](http://www.ilo.org/valuechains)
- Perera, B.M.O. Jayasuriya, M.C.N (2008), 'The Dairy Industry in Sri Lanka: Current States and Future Directions for a Greater Role in National Activity', *Journal of National Science Foundation*, 36, pp. 115-126.
- Porter, M.E., (1985), 'Competition Advantage Creating and Sustain Superior Performance', The FRER PRESS, New York.
- Porter, M.E., (1990), 'The Competition Advantage of Neutrinos', HARWARD Business Review.
- Porter, M.E., (2004), *Competitive Advantage: Creating and Sustaining Superior Performances*, Competitive Advantage Creating Sustaining Super Performance. 1, pp.94.
- QUARTZAFRICA, (2018), 'Cattle Theft in Kenya is being Tackled with Remote Tracking Chip Technology', <https://qz.com/africa/1197484/climate-change-kenya-cattle-theft-tackled-with-remote-tracking-chip-technology/>.
- Sepherd, A.W., (2007), 'Approaches to Linking Producers to Markets', Food and Agriculture Organization of the United Nation, Rome.
- Tegegne, A. (2017), 'Value Chain Analysis of Milk, Zuria District, South Wello Zone, Northern Ethiopia', IMMA University, Ethiopia.
- UNIDO, (2009), 'Agro Value Chain Analysis and Development', The UNIDO Approach. [aces.nmsu.edu/pubs/\\_d/D107](http://aces.nmsu.edu/pubs/_d/D107). Pdf.

Vidanapathirana, R., Rabukwella, R., Priyankara, E.A.C., (2017), 'Consumer Buying Behavior and Preference for Liquid Powdered Milk', Hector Kobbekaduwa Agrarian Research and Training Institute, Colombo, Sri Lanka.

Vishnoi, S., Pramendr, Gupta, V. Pooiya, R., (2015), 'Milk Production Function and Resource Use Efficiency in Jaipur District of Rajasthan', African Journal of Agricultural Research, 10 (32), PP. 320 –3205.

## Annexes

### Annex 01: Sample Distribution

District	VS Division	Method of Dairy Farming			Total	
		Intensive	Semi Intensive	Extensive		
Gampaha	Meerigama	2	3	10	15	
	Divulapitiya	2	4	0	6	
	Aththanagalla	1	1	0	2	
	Dompe	7	5	0	12	
	Nittabuwa	0	0	1	1	
Sub Total		12	13	11	<b>36</b>	
Percentage %		33.33	36.11	30.56	100	
Kandy	Gampola	10	5	0	15	
	Kuruduwatta	1	0	1	2	
	Teldeniya	0	1	0	1	
	Kundasale	1	8	1	10	
	Waththegama	1	1	0	2	
Sub Total		13	15	2	<b>30</b>	
Percentage %		43.33	50	6.67	100	
Kurunegala	Kuliyapitiya	4	7	0	11	
	Daladagama	2	5	4	11	
	Abanpola	0	2	0	2	
	Ahatuwewa	1	1	8	10	
	Galgamuwa	0	0	1	1	
	Polgahawela	0	0	1	1	
	Sub Total		7	15	14	<b>36</b>
	Percentage %		19.44	41.67	38.89	100
Anuradhapura	Galenbidunuwewa	4	6	0	10	
	Thalawa	1	6	0	7	
	Kekirawa	0	10	3	13	
Sub Total		5	22	3	<b>30</b>	
Percentage %		16.67	73.33	10	100	
Nuwara Eliya	Nuwara Eliya	3	5	0	8	
	Ragala	9	10	0	19	
	Walapane	1	1	0	2	
	Thalawakele	0	1	0	1	
Sub Total		13	17	0	<b>30</b>	
Percentage %		43.33	56.67	0	100	
Jaffna	Thirunaweli North	0	5	0	5	
	Thirunaweli Central	0	13	0	13	
	Kaaweddi	0	3	1	4	
	Coppai	0	8	0	8	
Sub Total		0	29	1	<b>30</b>	
Percentage %		0	96.67	3.33	100	
Total		50	111	31	192	
Percentage %		26.04	57.81	16.14	100	

## Annex 02: Cobb-Douglas production function regression analysis fact sheets

Assumption 1: The relationship between the IVs and the DV is linear.

Scatterplots show that this assumption had been met (although you would need to formally test each IV yourself).

Assumption 2: There is no multicollinearity in your data. 

Analysis of collinearity statistics show this assumption has been met, as VIF scores were well below 10, and tolerance scores above 0.2

Model	Unstandardized Coefficients		Standardized Coefficients	t	Sig.
	B	Std. Error	Beta		
(Constant)	.837	.100		8.381	.000
LN_X1	.414	.037	.490	11.036	.000
LN_X2	.073	.014	.202	5.089	.000
LN_X3	.040	.019	.085	2.114	.036
LN_X6	.085	.010	.391	8.892	.000
LN_X7	-.047	.059	-.031	-.795	.428
LN_X10	.042	.060	.027	.691	.490

Dependent Variable: LN\_Y

Assumption 3: The values of the residuals are independent.

The Durbin-Watson statistic showed that this assumption had been met, as the obtained value was close to 2

Model	R	R Square	Adjusted R Square	Std. Error of the Estimate	Durbin-Watson
1	.859 <sup>a</sup>	.738	.732	.37238	1.712

Assumption 4: The variance of the residuals is constant.

Our plot of standardized residuals vs standardized predicted values showed no obvious signs of funneling; suggesting the assumption of homoscedasticity has been met.

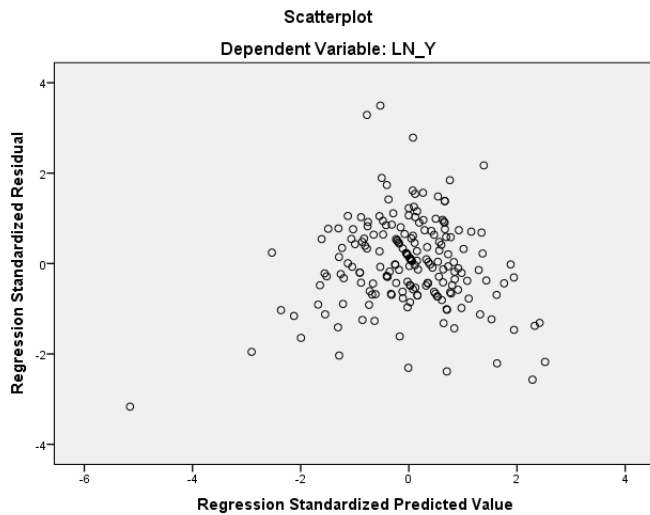

Assumption 5: The values of the residuals are normally distributed.

This assumption can be tested by looking at the P-P plot for the model. The closer the dots lie to the diagonal line, the closer to normal the residuals are distributed.

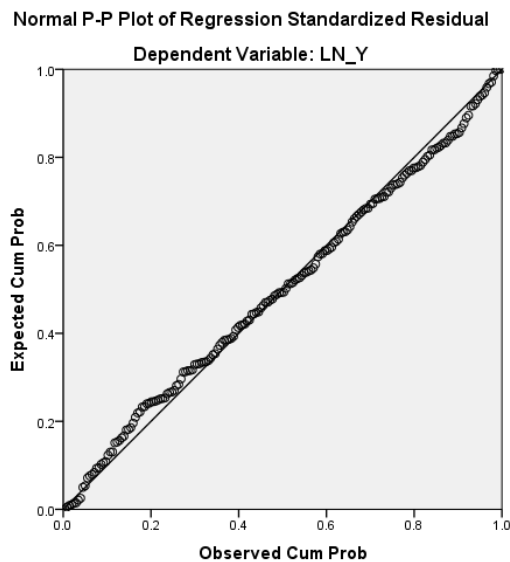

Assumption 6: There are no influential cases biasing your model.

Cook's Distance values were all under 1, suggesting individual cases were not unduly influencing the model.